

An Algebraic Axiomatisation of ZX-calculus

Quanlong Wang

Cambridge Quantum Computing Ltd.

harny.wang@cambridgequantum.com

ZX-calculus is a graphical language for quantum computing which is complete in the sense that calculation in matrices can be done in a purely diagrammatic way. However, all previous universally complete axiomatisations of ZX-calculus have included at least one rule involving trigonometric functions such as sin and cos which makes it difficult for application purpose. In this paper we give an algebraic complete axiomatisation of ZX-calculus instead such that there are only ring operations involved for phases. With this algebraic axiomatisation of ZX-calculus, we are able to establish for the first time a simple translation of diagrams from another graphical language called ZH-calculus and to derive all the ZX-translated rules of ZH-calculus. As a consequence, we have a great benefit that all techniques obtained in ZH-calculus can be transplanted to ZX-calculus, which can't be obtained by just using the completeness of ZX-calculus.

1 Introduction

The ZX-calculus was introduced by Coecke and Duncan [7] as a graphical language for quantum computing, based on the framework of compact closed categories. The core part of ZX-calculus is a pair of spiders (complementary observables) with strong complementarity [8]. The ZX-calculus can also be seen as a form of PROP [17], thus it is usually presented by generators and rewriting rules.

There are three important properties of ZX-calculus: soundness, universality and completeness. Soundness means all the ZX rewriting rules hold when interpreted by matrices. Universality means each matrix (linear map between finite dimensional Hilbert Spaces) can be represented by a ZX diagram. Finally, completeness means each diagrammatic equality can be derived from ZX rules if their corresponding matrix equality holds in finite dimensional Hilbert Spaces. The soundness and universality of ZX-calculus have been proved in [7]. The universal completeness of ZX-calculus (which means ZX-calculus is complete for the full pure qubit quantum mechanics instead of any part of it) was first given in [19] and then incorporated in [12]. The feature of this complete axiomatisation is that it has two new generators: the λ box and the triangle symbol (which first appeared in [13] as a short notation for some diagram composed of mere green and red nodes). Based on some results in [19], there came another universal complete axiomatisation of ZX-calculus [14] with only traditional generators as given in [7]. Thereafter, two more universal complete axiomatisations of ZX-calculus were presented [15], [21]. All of these universal complete axiomatisations of ZX-calculus have some non-algebraic rule involved with trigonometry functions such as sin or cos. For example, the following so-called (P) rule [10] is deployed in [21] (with scalars added) as a key rule for universal completeness.

$$\begin{array}{c} \alpha_1 \\ \beta_1 \\ \gamma_1 \end{array} = \begin{array}{c} \alpha_2 \\ \beta_2 \\ \gamma_2 \end{array} \quad \text{with} \quad \left\{ \begin{array}{l} \alpha_2 = \arg z + \arg z_1 \\ \beta_2 = 2 \arg(|\frac{z}{z_1}| + i) \\ \gamma_2 = \arg z - \arg z_1 \end{array} \right. \quad (1)$$

where:

$$\begin{aligned} z &= \cos \frac{\beta_1}{2} \cos \frac{\alpha_1 + \gamma_1}{2} + i \sin \frac{\beta_1}{2} \cos \frac{\alpha_1 - \gamma_1}{2} \\ z_1 &= \cos \frac{\beta_1}{2} \sin \frac{\alpha_1 + \gamma_1}{2} - i \sin \frac{\beta_1}{2} \sin \frac{\alpha_1 - \gamma_1}{2} \end{aligned}$$

One could imagine that it would be very hard to use such a rule directly if there are trigonometry functions involved. For example, in (1), if we take $\alpha_1 = \frac{\pi}{4}$, $\beta_1 = -\frac{\pi}{4}$, $\gamma_1 = \frac{\pi}{2}$, then by tedious calculation one can get that $\alpha_2 = \arctan(-\sqrt{2})$, $\beta_2 = -\frac{\pi}{3}$, $\gamma_2 = \arctan(\frac{-1}{\sqrt{2}})$; or $\alpha_2 = \pi - \arctan(\sqrt{2})$, $\beta_2 = \frac{\pi}{3}$, $\gamma_2 = \pi - \arctan(\frac{1}{\sqrt{2}})$. This means simple angles can be turned into complicated angles, thus not easy to deal with in applications.

In this paper we overcome this drawback by giving a new complete axiomatisation of ZX-calculus with purely algebraic rules, in the sense that there are only ring operations involved for phases. One of the features of this axiomatisation in comparison to the previous ones is that we deploy a generator which is first introduced in [20] diagrammatically represented by green box with parameters ranging in any complex numbers. The usefulness of the new generator has been fully shown in [10] by its power in deriving the (P) rule. We obtain the completeness by deriving all the rules in [12] from this new set of algebraic rules. One significant application of these algebraic rules is the derivation of the so-called spider nest identities [18], which are key to the T-count reduction of quantum circuits [4, 5]. The axiomatisation in [12] also has a triangle diagram as a generator as is the same case for the algebraic axiomatisation, whereas the former axiomatisation has a non-algebraic rule and its triangle-involved rules are more complicated than that of the latter. We point out that both the green box and the triangle are not really external to the original generators usually described as green and red spiders [7], they actually can be expressed in terms of those original generators, though in a complicated form [19, 12].

Furthermore, for another graphical language for quantum computing called ZH-calculus [1], which has applications in various fields like tensor network [6] and hypergraph states [16], we give a simple translation from the full ZH-calculus to ZX-calculus for the first time. Via this translation and the algebraic rules, we are able to derive all the ZX-translated ZH rules from the algebraic ZX rules. Although in principle we know this can be done because of the completeness of ZX-calculus, that doesn't help us to gain a great benefit that all techniques obtained in ZH-calculus can be transplanted to ZX-calculus. Only by the detailed derivations using the algebraic rules could we have such bonus for ZX-calculus.

2 Algebraic axiomatisation of ZX-calculus

The ZX-calculus is based on a compact closed PROP [17], which is a strict symmetric monoidal category whose objects are generated by one object, with a compact structure [9] as well. Each PROP can be described as a presentation in terms of generators and relations [3].

First we give the generators of ZX-calculus in the following table. Note that all the diagrams in this paper should be read from top to bottom.

$R_{Z,a}^{(n,m)} : n \rightarrow m$		$H : 1 \rightarrow 1$	
$I : 1 \rightarrow 1$		$\sigma : 2 \rightarrow 2$	
$C_a : 0 \rightarrow 2$		$C_u : 2 \rightarrow 0$	
$T : 1 \rightarrow 1$		$T^{-1} : 1 \rightarrow 1$	

Table 1: Generators of ZX-calculus, where $m, n \in \mathbb{N}$, $a \in \mathbb{C}$.

Remark 2.1 The generator $R_{Z,a}^{(n,m)}$ is first introduced in [20]. It seems that the generators $R_{Z,a}^{(n,m)}$, T and T^{-1} are totally external to the original generators usually described as green and red spiders [7], but they can actually be expressed in terms of those original generators, though in a complicated form [19, 12]. Here we just show that for T and T^{-1} as follows:

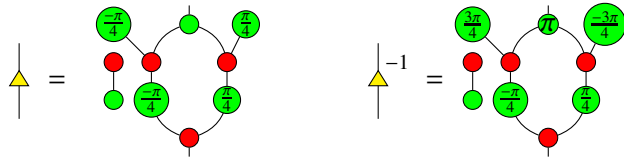

Also we define some diagrams as follows:

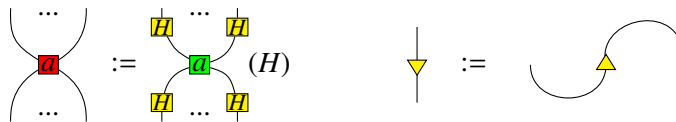

For simplicity, we make the following conventions:

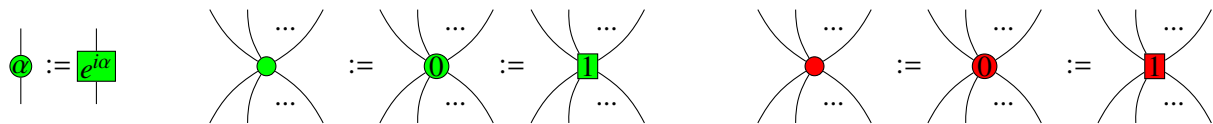

and

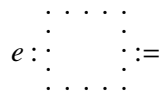

which means e represents an empty diagram.

There is a standard interpretation $\llbracket \cdot \rrbracket$ for the ZX diagrams:

$$\left[\left[\begin{array}{c} \overbrace{\quad\quad\quad}^n \\ \dots \\ \text{■} \\ \dots \\ \underbrace{\quad\quad\quad}_m \end{array} \right] \right] = |0\rangle^{\otimes m} \langle 0|^{\otimes n} + a |1\rangle^{\otimes m} \langle 1|^{\otimes n},$$

$$\left[\left[\begin{array}{c} \overbrace{\quad\quad\quad}^n \\ \dots \\ \text{■} \\ \dots \\ \underbrace{\quad\quad\quad}_m \end{array} \right] \right] = |+\rangle^{\otimes m} \langle +|^{\otimes n} + a |-\rangle^{\otimes m} \langle -|^{\otimes n},$$

$$\left[\left[\begin{array}{c} \text{■} \\ | \end{array} \right] \right] = \frac{1}{\sqrt{2}} \begin{pmatrix} 1 & 1 \\ 1 & -1 \end{pmatrix}, \quad \left[\left[\begin{array}{c} \vdots \\ \vdots \\ \vdots \\ \vdots \end{array} \right] \right] = 1, \quad \left[\left[\begin{array}{c} | \\ | \end{array} \right] \right] = \begin{pmatrix} 1 & 0 \\ 0 & 1 \end{pmatrix},$$

$$\left[\left[\begin{array}{c} \text{▲} \\ | \end{array} \right] \right] = \begin{pmatrix} 1 & 1 \\ 0 & 1 \end{pmatrix}, \quad \left[\left[\begin{array}{c} \text{▲}^{-1} \\ | \end{array} \right] \right] = \begin{pmatrix} 1 & -1 \\ 0 & 1 \end{pmatrix}.$$

$$\left[\left[\begin{array}{c} \text{X} \end{array} \right] \right] = \begin{pmatrix} 1 & 0 & 0 & 0 \\ 0 & 0 & 1 & 0 \\ 0 & 1 & 0 & 0 \\ 0 & 0 & 0 & 1 \end{pmatrix}, \quad \left[\left[\begin{array}{c} \text{C} \end{array} \right] \right] = \begin{pmatrix} 1 \\ 0 \\ 0 \\ 1 \end{pmatrix}, \quad \left[\left[\begin{array}{c} \text{C} \end{array} \right] \right] = (1 \ 0 \ 0 \ 1),$$

$$\llbracket D_1 \otimes D_2 \rrbracket = \llbracket D_1 \rrbracket \otimes \llbracket D_2 \rrbracket, \quad \llbracket D_1 \circ D_2 \rrbracket = \llbracket D_1 \rrbracket \circ \llbracket D_2 \rrbracket,$$

where

$$\begin{aligned} |0\rangle &= \begin{pmatrix} 1 \\ 0 \end{pmatrix}, & \langle 0| &= (1 \ 0), & |1\rangle &= \begin{pmatrix} 0 \\ 1 \end{pmatrix}, & \langle 1| &= (0 \ 1), \\ |+\rangle &= \frac{1}{\sqrt{2}} \begin{pmatrix} 1 \\ 1 \end{pmatrix}, & \langle +| &= \frac{1}{\sqrt{2}} (1 \ 1), & |-\rangle &= \frac{1}{\sqrt{2}} \begin{pmatrix} 1 \\ -1 \end{pmatrix}, & \langle -| &= \frac{1}{\sqrt{2}} (1 \ -1). \end{aligned}$$

Now we give a purely algebraic set of rules for ZX-calculus in the sense that there are no trigonometry functions such as sin and cos involved.

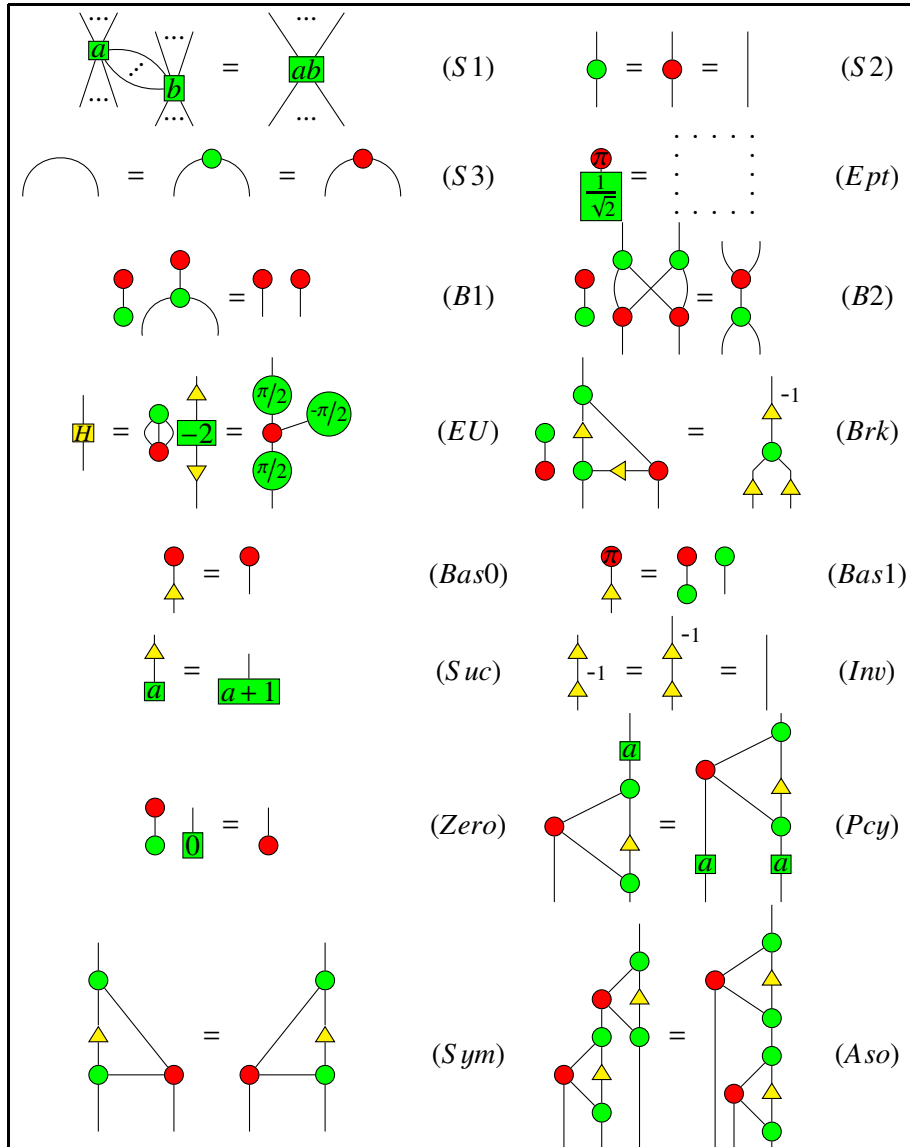



Figure 1: Algebraic rules, $a, b \in \mathbb{C}$.

Remark 2.2 The last three rules are all about the properties of the W state : (Pcy) means phase copy, i.e., any phase can be copied by the W state; (Sym) means symmetry, i.e., the W state is symmetric; (Aso) means associativity, i.e., the W state is associative. In addition, the rules (H) and (S1) are first introduced in [20].

It is a routine check that these rules are sound in the sense that they still hold under the standard interpretation $\llbracket \cdot \rrbracket$. We mention again that a significant application of these algebraic rules is the derivation of the so-called spider nest identities [18], which are key to the T-count reduction of quantum circuits [4, 5].

With the standard interpretation and the above rules, we can define the completeness of ZX-calculus.

Definition 2.3 *The ZX-calculus is called complete if for any two diagrams D_1 and D_2 , $\llbracket D_1 \rrbracket = \llbracket D_2 \rrbracket$ must imply that $ZX \vdash D_1 = D_2$.*

Remark 2.4 *All the rules in Figure 1 now are algebraic, and they will be proved to be a complete axiomatisation of ZX-calculus. One may wonder how these rules are obtained. The answer is simply that giving rules is actually a constructive thing, and these rules are basically refined from plenty of practice of diagrammatical rewriting based on the previous rules [12]. The reason why trigonometry functions can be eliminated in this new set of rules is because the generators we have chosen in Table 1 allow an algebraic translation (an isomorphic functor in fact) from the ZW-calculus which is algebraic at the beginning [12]. Furthermore, we note that this new set of algebraic rules are not unique, as one could add more rules to the set or derive equivalent rules from them. The most important thing for choosing a set of rules is that they should be useful in applications as much as possible.*

Below we give some useful properties following from Figure 1.

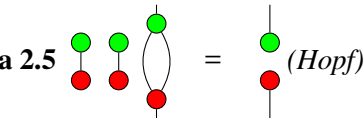
Lemma 2.5  (Hopf)

This has been proved in [2] based on rules (S1), (S2), (S3), (B1), (B2) and the definition of red spider.

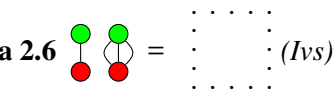
Lemma 2.6  (Ivs)

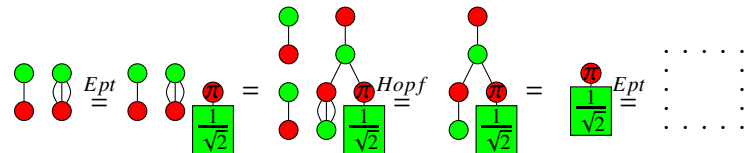
Proof:  □

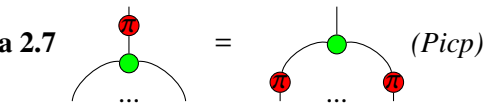
Lemma 2.7  (Picp)

This has been proved in [2] based on rules (S1), (S2), (S3), (B1), (B2) and the definition of red spider.

Lemma 2.8  (Com)

This has been proved in [2] based on rules (S1), (S2), (S3), (B1), (B2) and the definition of red spider.

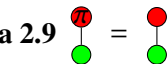
Lemma 2.9 

Proof:  □

3 Proof of completeness

In this section, we prove that the rules in Figure 1 are complete for ZX-calculus. Since it is already proved in [12] that ZX-calculus is complete with the rules presented in Figure 2 and Figure 3, we only need to prove that all the rules in Figure 2 and 3 can be derived from rules in Figure 1.

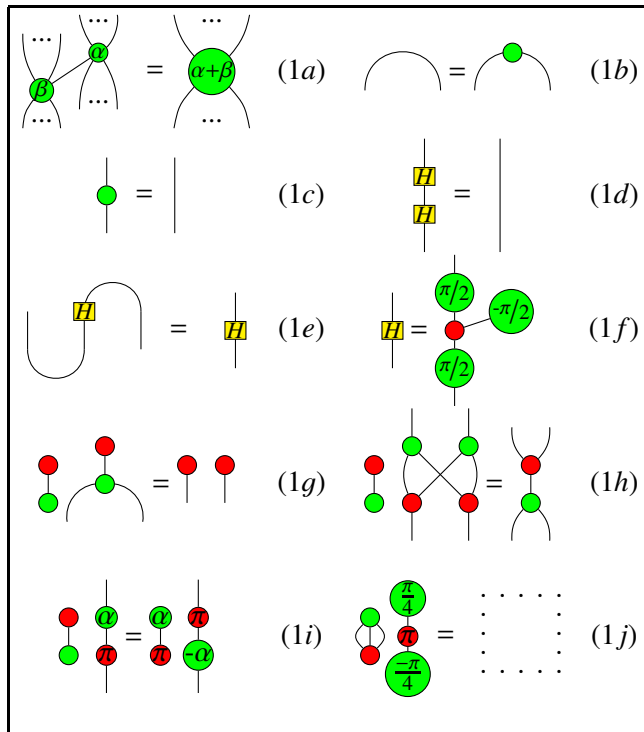

Figure 2: Previous ZX-calculus rules I, where $\alpha, \beta \in [0, 2\pi)$.

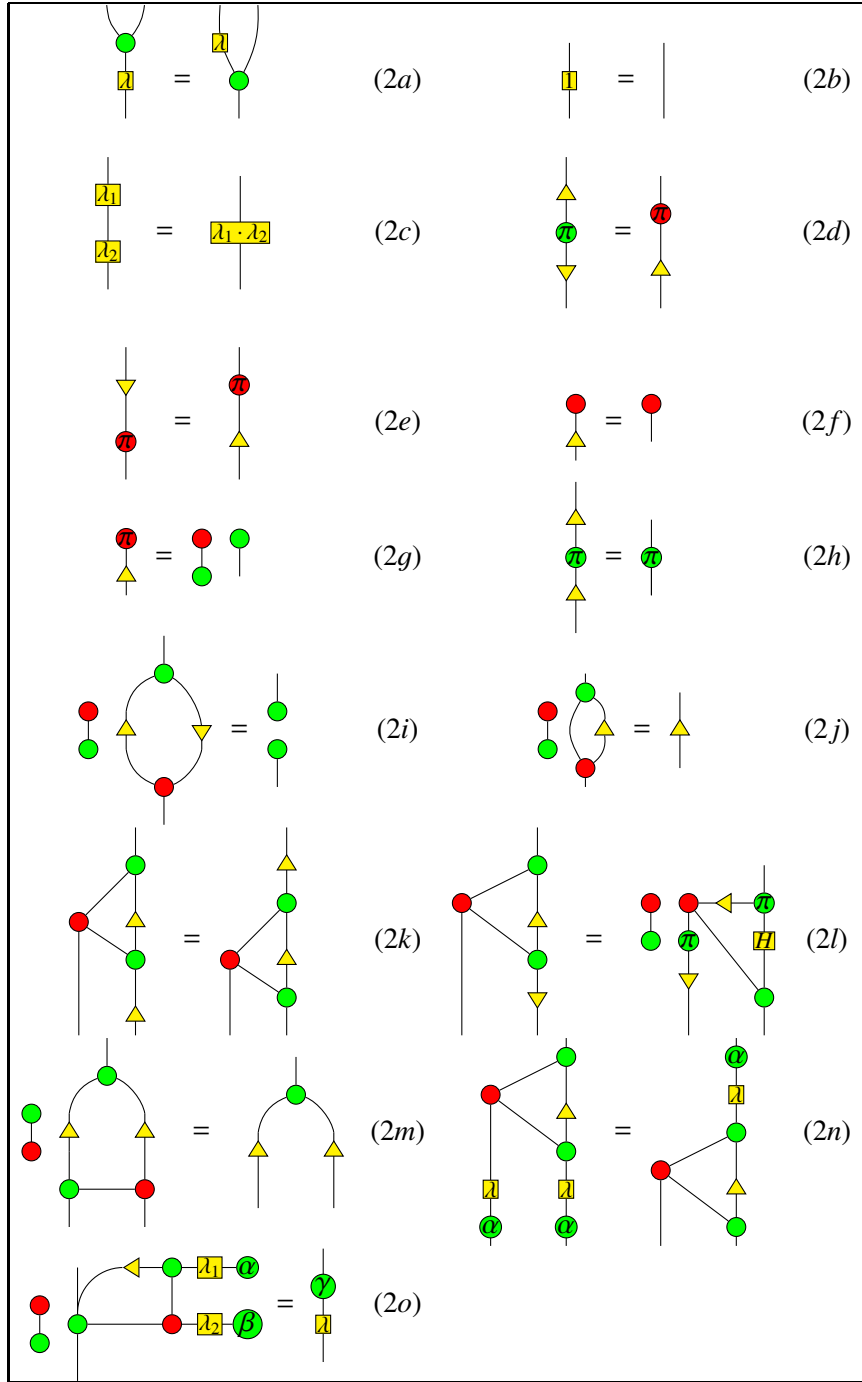

Figure 3: Previous ZX-calculus rules II, where $\lambda, \lambda_1, \lambda_2 \geq 0, \alpha, \beta, \gamma \in [0, 2\pi)$; in (2o), $\lambda e^{i\gamma} = \lambda_1 e^{i\alpha} + \lambda_2 e^{i\beta}$.

Remark 3.1 *In the rule (2o), the equality $\lambda e^{i\gamma} = \lambda_1 e^{i\alpha} + \lambda_2 e^{i\beta}$ is not expressed in terms of trigonometry functions, but if we solve this equation to give the relations between the angles, then we get $\lambda = \sqrt{\lambda_1^2 + \lambda_2^2 + 2\lambda_1\lambda_2 \cos(\alpha - \beta)}$, $\gamma = \alpha + \arccos(\frac{\lambda_1 + \lambda_2 \cos(\alpha - \beta)}{\lambda})$, if $\lambda \neq 0$; and $\alpha = \beta + k\pi$, $|\lambda_1| = |\lambda_2|$, γ can be any angle, if $\lambda = 0$.*

Remark 3.2 *The main difference between the algebraic axiomatisation in this paper and the previous axiomatisation in [12] lies in that we use as generator a green box with parameters ranging over complex numbers in the algebraic axiomatisation rather than a yellow box with parameters ranging over non-negative real numbers in the previous axiomatisation. Furthermore, the rules with triangles involved in Figure 1 are simpler and more natural than those with triangles involved as shown in Figure 3. The usefulness of the new generator green box has been fully shown in [10] through the derivation of the (P) rule with the main help from the green box.*

Theorem 3.3 *ZX-calculus is complete for pure qubit quantum mechanics with the rules listed in Figure 1.*

The proof is given in the appendix.

4 From ZH-calculus to ZX-calculus

ZH-calculus is another graphical language for quantum computing introduced by Backens and Kissinger [1]. It has found applications in various fields like tensor network [6] and hypergraph states [16]. So it would be very useful if we could establish a connection between ZH-calculus and ZX-calculus. In [22], there are translations established between phase-free ZH-calculus and ZX-calculus, yet there has been no translation found between the full ZH-calculus and ZX-calculus. In this section, with the algebraic axiomatisation of ZX-calculus, we are able to give a simple translation from any ZH diagrams to ZX diagrams with the semantics preserved. Furthermore, we derive all the translated ZH rules within ZX by the algebraic rules given in Figure 1. Although in principle we know this can be done because of the completeness of ZX-calculus, but that is not a constructive way. We give the details of all such derivations which is far from trivial especially for the last three ZH rules, which means the translation from ZH diagrams to ZX diagrams alone doesn't guarantee an easy derivation of the ZH rules. By these translation and rule-derivation we have the bonus that any result obtained via ZH-calculus can be transplanted to ZX-calculus.

The ZH-calculus is also based on a PROP, thus can be presented by generators and rewriting rules. First we list its generators as follows [1]:

$Z^{(n,m)} : n \rightarrow m$		$H_a^{(n,m)} : n \rightarrow m$	
$\mathbb{I} : 1 \rightarrow 1$		$\sigma : 2 \rightarrow 2$	
$C_a : 0 \rightarrow 2$		$C_u : 2 \rightarrow 0$	

Table 2: Generators of ZH-calculus, where $m, n \in \mathbb{N}$, $a \in \mathbb{C}$.

There is also a standard interpretation $\llbracket \cdot \rrbracket$ for the ZH diagrams, here we only present the interpretation of the first two generators, as other generators are the same as that of ZX-calculus:

$$\llbracket \text{White Spider} \rrbracket = |0\rangle^{\otimes m} \langle 0|^{\otimes n} + |1\rangle^{\otimes m} \langle 1|^{\otimes n},$$

$$\llbracket \text{Spider}(a) \rrbracket = \sum a^{i_1 \dots i_m j_1 \dots j_n} |i_1 \dots i_m\rangle \langle j_1 \dots j_n|.$$

It is clear that the white spider in ZH-calculus is just the phase free green spider in ZX-calculus. Thus we can give a semantics-preserving translation $\llbracket \cdot \rrbracket_{HX}$ from ZH-calculus to ZX-calculus via the translation of H-box:

$$\llbracket \text{Spider}(a) \rrbracket_{HX} = \text{H-box}(a)$$

This translation is totally new. Following [1], we make the convention that

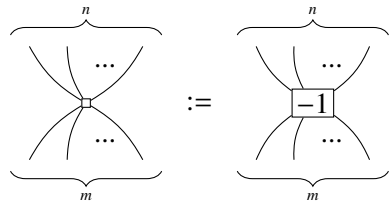

then the ZH rules are given as follows:

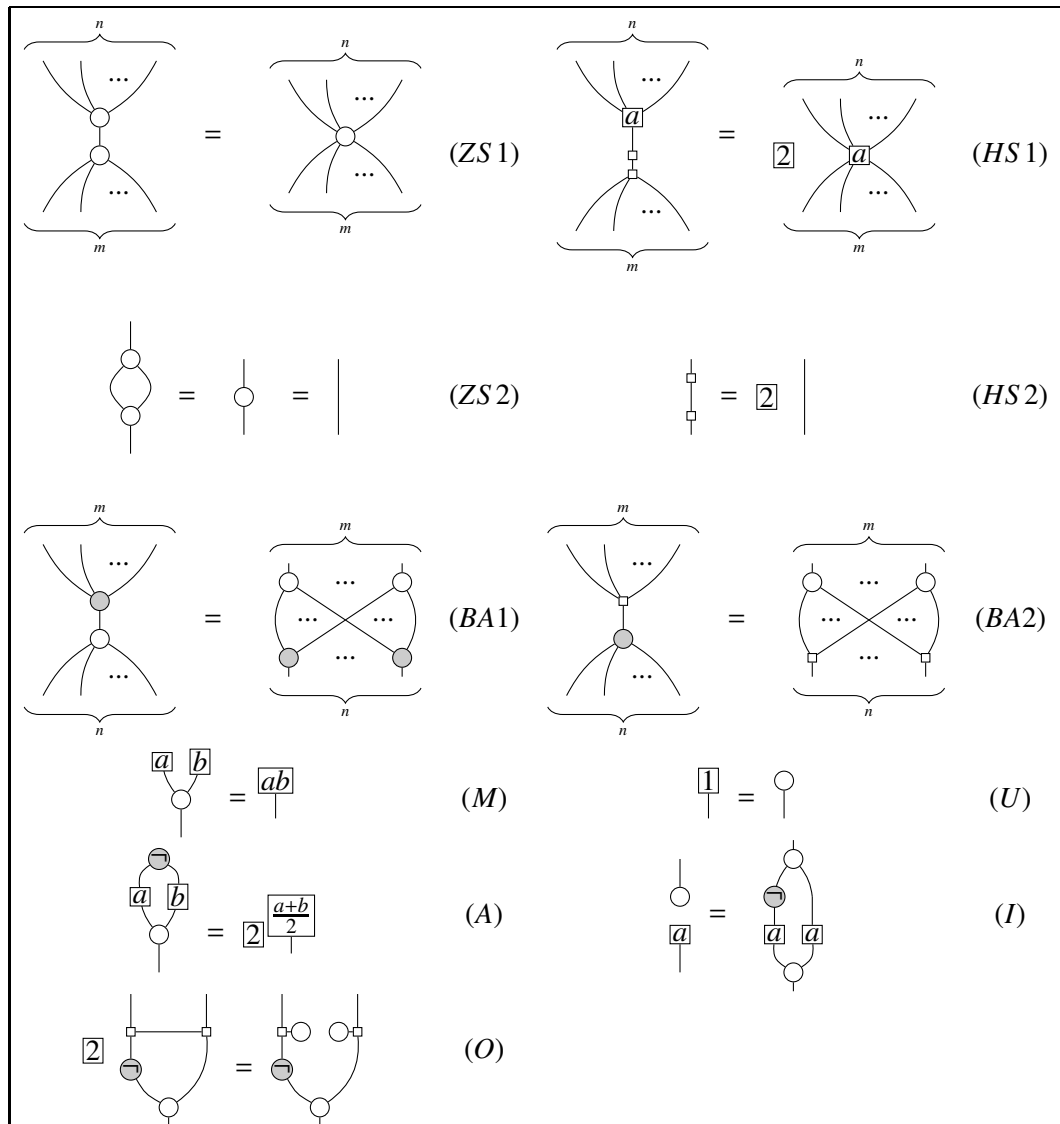

Figure 4: ZH rules, where $a, b \in \mathbb{C}$.

Now we derive the ZX-translated rules in Figure 4 from ZX rules.

The rules (ZS1), (ZS2), (M) and (U) just follow directly from the ZX rules (S1) and (S2). The rule (HS2) follows directly the ZX rule (S2) and the definition (H) of red spider. The ZH rule (BA1) is just a generalisation of the ZX rule (B2), which has been proved in ZX papers, for example [11]. So we only need to derive the remaining ZH rules (HS1), (A) (I) and (O) individually. This has been shown in the appendix.

Therefore, we have

Theorem 4.1 *All the ZX-translated ZH rules can be derived from ZX rules.*

Remark 4.2 *Obviously, the completeness of ZX-calculus already implies that all the ZX-translated ZH rules can be derived from ZX rules. However, that is not a constructive proof, so we have no idea on how such derivation really happens. The consequence is that it does no help to ZX-calculus even if there is a great result obtained in the ZH-calculus. In another word, to know the conclusion that all the ZX-translated ZH rules can be derived from ZX rules is not enough, we need to show the details of the derivations.*

5 Conclusion and further work

In this paper, we give a purely algebraic axiomatisation of ZX-calculus by introducing new generators. We show the proof of completeness by deriving complete rules established previously. Based on this algebraic axiomatisation, we obtain a simple translation of diagrams from ZH-calculus to ZX-calculus, and derive all the ZX-translated ZH rules within ZX-calculus.

In the next step, we would like to have a proof of completeness based on the algebraic rules presented in this paper via a normal form, rather than a translation from other graphical language. It is also interesting to go for another direction: translate diagrams from ZX-calculus to ZH-calculus and derive the ZX rules within ZH-calculus. Finally, it is worthwhile to apply these algebraic rules to the problem of quantum circuit optimisation.

Acknowledgements

This work was supported by AFOSR grant FA2386-18-1-4028. The author would like to thank Aleks Kissinger for showing him the proof of the distribution rule in ZH-calculus. The author thanks Bob Coecke, Niel de Beaudrap and Konstantinos Meichanetzidis for useful discussions on the title of this paper.

References

- [1] Miriam Backens & Aleks Kissinger (2018): *ZH: A Complete Graphical Calculus for Quantum Computations Involving Classical Non-linearity*. In: *Proceedings of the 15th International Workshop on Quantum Physics and Logic, QPL 2018, Halifax, Canada, 3-7th June 2018.*, pp. 23–42, doi:10.4204/EPTCS.287.2.
- [2] Miriam Backens, Simon Perdrix & Quanlong Wang (2017): *A Simplified Stabilizer ZX-calculus*. *EPTCS* 236, pp. 1–20, doi:10.4204/EPTCS.236.1.
- [3] John C. Baez, Brandon Coxa & Franciscus Rebro (2018): *Props in Network Theory. Theory and Applications of Categories* 33(25), pp. 727 – 783. arXiv:1707.08321.

- [4] Niel de Beaudrap, Xiaoning Bian & Quanlong Wang (2020): *Fast and Effective Techniques for T-Count Reduction via Spider Nest Identities*. In Steven T. Flammia, editor: *15th Conference on the Theory of Quantum Computation, Communication and Cryptography, TQC 2020, June 9-12, 2020, Riga, Latvia, LIPIcs* 158, Schloss Dagstuhl - Leibniz-Zentrum für Informatik, pp. 11:1–11:23, doi:10.4230/LIPIcs.TQC.2020.11.
- [5] Niel de Beaudrap, Xiaoning Bian & Quanlong Wang (2020): *Techniques to Reduce $\pi/4$ -Parity-Phase Circuits, Motivated by the ZX Calculus*. In Bob Coecke & Matthew Leifer, editors: *Proceedings 16th International Conference on Quantum Physics and Logic*, Chapman University, Orange, CA, USA., 10-14 June 2019, *Electronic Proceedings in Theoretical Computer Science* 318, Open Publishing Association, pp. 131–149, doi:10.4204/EPTCS.318.9.
- [6] Niel de Beaudrap, Aleks Kissinger & Konstantinos Meichanetzidis (2020): *Tensor Network Rewriting Strategies for Satisfiability and Counting*. To appear in *Proceedings 17th International Conference on Quantum Physics and Logic*. arXiv:2004.06455.
- [7] Bob Coecke & Ross Duncan (2011): *Interacting quantum observables: categorical algebra and diagrammatics*. *New Journal of Physics* 13(4), p. 043016, doi:10.1088/1367-2630/13/4/043016. Available at <http://stacks.iop.org/1367-2630/13/i=4/a=043016>.
- [8] Bob Coecke, Ross Duncan, Aleks Kissinger & Quanlong Wang (2012): *Strong Complementarity and Non-locality in Categorical Quantum Mechanics*. In: *Proceedings of the 2012 27th Annual IEEE/ACM Symposium on Logic in Computer Science, LICS '12*, IEEE Computer Society, pp. 245–254, doi:10.1109/LICS.2012.35.
- [9] Bob Coecke & Aleks Kissinger (2017): *Picturing quantum processes*. Cambridge University Press, doi:10.1017/9781316219317.
- [10] Bob Coecke & Quanlong Wang (2018): *ZX-rules for 2-qubit Clifford+T Quantum Circuits*. In: *Proceedings of the 10th International Conference, Reversible Computation 2018*, LNCS, pp. 144–161, doi:10.1007/978-3-319-99498-7_10.
- [11] Ross Duncan & Simon Perdrix (2009): *Graph States and the Necessity of Euler Decomposition*. *Mathematical Theory and Computational Practice* 5635, pp. 167–177, doi:10.1007/978-3-642-03073-4_18.
- [12] Amar Hadzihasanovic, Kang Feng Ng & Quanlong Wang (2018): *Two Complete Axiomatisations of Pure-state Qubit Quantum Computing*. In: *Proceedings of the 33rd Annual ACM/IEEE Symposium on Logic in Computer Science, LICS '18*, ACM, pp. 502–511, doi:10.1145/3209108.3209128.
- [13] Emmanuel Jeandel, Simon Perdrix & Renaud Vilmart (2018): *A Complete Axiomatisation of the ZX-Calculus for Clifford+T Quantum Mechanics*. In: *Proceedings of the 33rd Annual ACM/IEEE Symposium on Logic in Computer Science, LICS '18*, ACM, New York, NY, USA, pp. 559–568, doi:10.1145/3209108.3209131.
- [14] Emmanuel Jeandel, Simon Perdrix & Renaud Vilmart (2018): *Diagrammatic Reasoning Beyond Clifford+T Quantum Mechanics*. In: *Proceedings of the 33rd Annual ACM/IEEE Symposium on Logic in Computer Science, LICS '18*, ACM, New York, NY, USA, pp. 569–578, doi:10.1145/3209108.3209139.
- [15] Emmanuel Jeandel, Simon Perdrix & Renaud Vilmart (2019): *A Generic Normal Form for ZX-Diagrams and Application to the Rational Angle Completeness*. In: *34th Annual ACM/IEEE Symposium on Logic in Computer Science, LICS 2019, Vancouver, BC, Canada, June 24-27, 2019*, pp. 1–10, doi:10.1109/LICS.2019.8785754.
- [16] Louis Lemonnier, John van de Wetering & Aleks Kissinger (2020): *Hypergraph simplification: Linking the path-sum approach to the ZH-calculus*. To appear in *Proceedings 17th International Conference on Quantum Physics and Logic*. arXiv:2003.13564.
- [17] Saunders MacLane (1965): *Categorical algebra*. *Bulletin of the American Mathematical Society* 71(1), pp. 40–106, doi:10.1090/S0002-9904-1965-11234-4. <https://projecteuclid.org/443/euclid.bams/1183526392>.
- [18] Anthony Munson, Bob Coecke & Quanlong Wang (2020): *AND-gates in ZX-calculus: spider nest identities and QBC-completeness*. To appear in *Proceedings 17th International Conference on Quantum Physics and Logic*. arXiv:1910.06818.

[19] Kang Feng Ng & Quanlong Wang (2017): *A universal completion of the ZX-calculus*. arXiv:1706.09877.
 [20] Kang Feng Ng & Quanlong Wang (2018): *Completeness of the ZX-calculus for Pure Qubit Clifford+T Quantum Mechanics*. arXiv:1801.07993.
 [21] Renaud Vilmart (2019): *A Near-Minimal Axiomatisation of ZX-Calculus for Pure Qubit Quantum Mechanics*. In: *34th Annual ACM/IEEE Symposium on Logic in Computer Science, LICS 2019, Vancouver, BC, Canada, June 24-27, 2019*, pp. 1–10, doi:10.1109/LICS.2019.8785765.
 [22] John van de Wetering & Sal Wolffs (2019): *Completeness of the Phase-free ZH-calculus*. arXiv:1904.07545.

Appendix: Propositions, Lemmas and Proofs

Proof of Theorem 3.3

Below we use the rules from Figure 1 to derive the rules in Figure 2 and 3 one by one.

First (1a), (1b) and (1c) follow directly from (S1), (S3) and (S2) respectively. (1d) follows clearly from (S2) and the definition of red spider. (1e) follows from (1d) and (S3). (1f) is just a part of (EU). (1g) and (1h) are exactly (B1) and (B2) respectively.

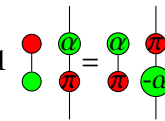
Proposition 5.1  (1i)

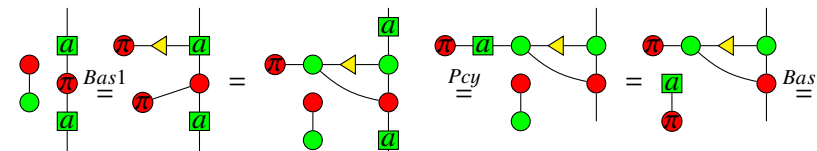
Proof:  (1i) follows when setting $a = e^{i\alpha}$. □

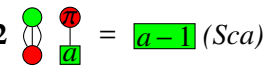
Lemma 5.2  (Sca)

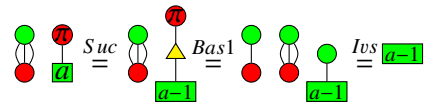
Proof:  □

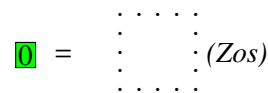
Corollary 5.3  (Zos)

Proof: Let $a = 1$ in (Sca) and use (Ivs) and Lemma 2.9. □

Lemma 5.4  (Sml)

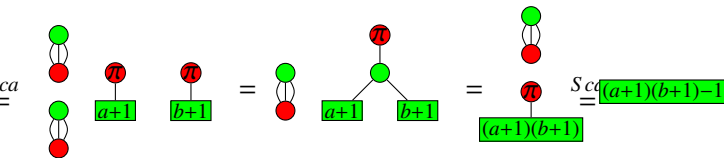
Proof:  □

Lemma 5.5  (Irt)

Proof:  \square

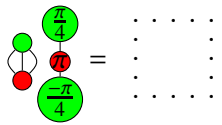
Proposition 5.6  $(1j)$

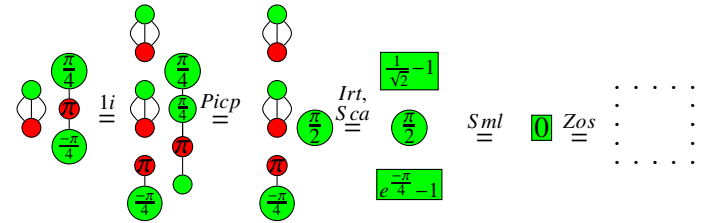
Proof:  \square

Note that $\downarrow = \uparrow$. Then (2a) and (2c) follow directly from (S1). (2b) directly follows from (S2).

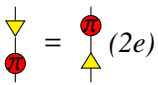
Proposition 5.7  $(2e)$

Proof:

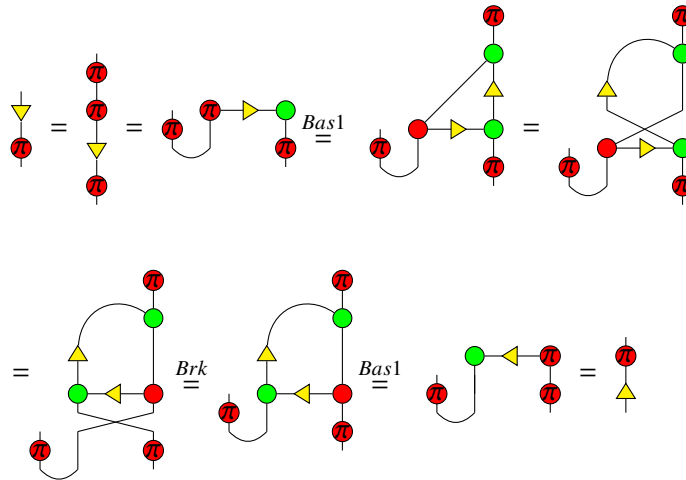

\square

(2f) and (2g) are exactly (Bas0) and (Bas1) respectively.

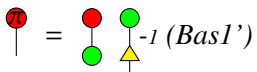
Lemma 5.8  $-1 (Bas1')$

This can be directly obtained by plugging a triangle inverse on both sides of (Bas1).

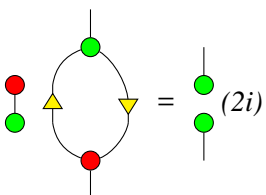
Proposition 5.9  $(2i)$

Proof:

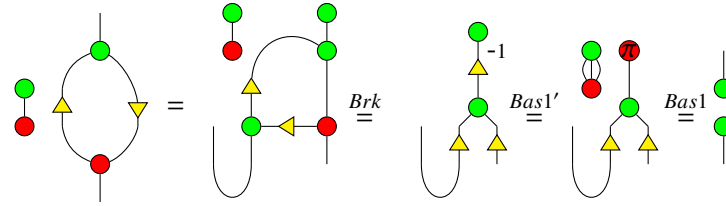

□

Proposition 5.10

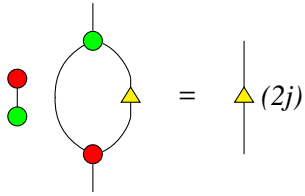

Proof:

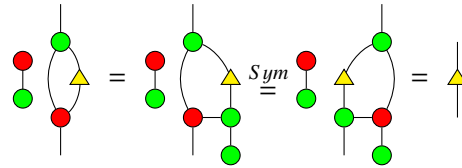

□

Corollary 5.11

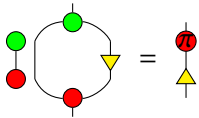

(2)

Proof:

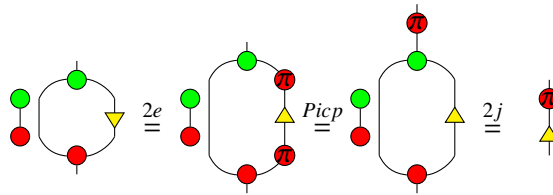

□

Proposition 5.12

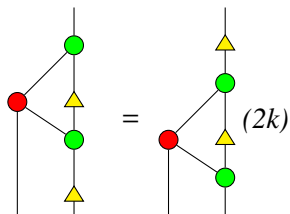

Proof:

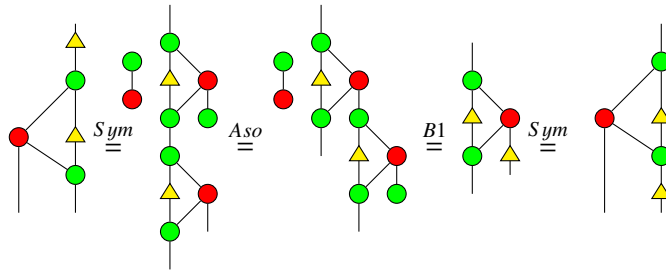

□

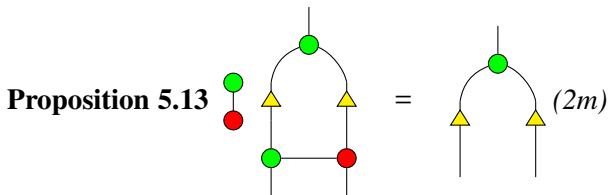

Proof:

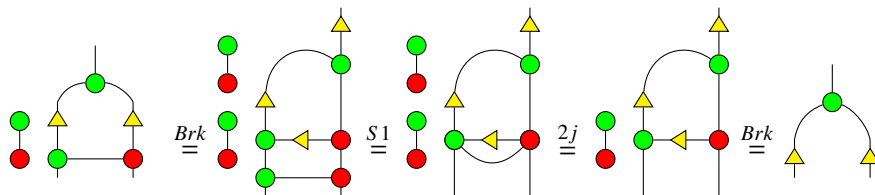

□

Corollary 5.14

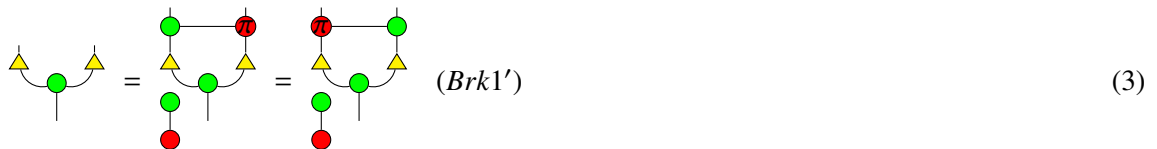

Proof:

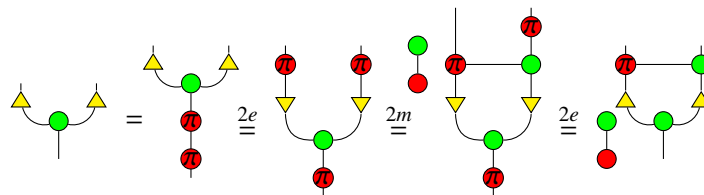

The other part can be proved by symmetry.

□

(2n) is just the rule (Pcy).

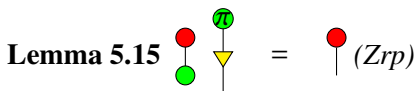

By the rule (Suc), it is clear that (Zrp) is equivalent to the rule (Zero).

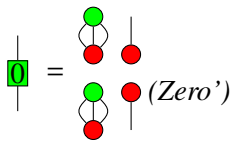
Lemma 5.16  (Zero')

Proof:

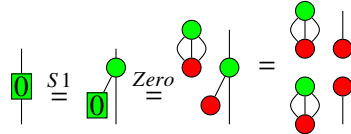

□

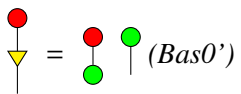
Lemma 5.17  (Bas0')

Proof:

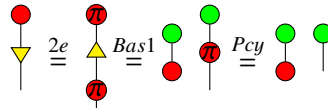

□

Lemma 5.18

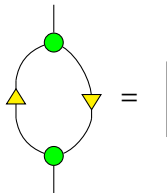

(4)

Proof:

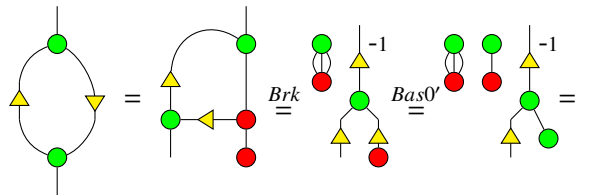

□

Lemma 5.19

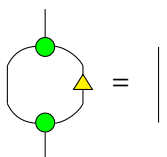

(5)

Proof:

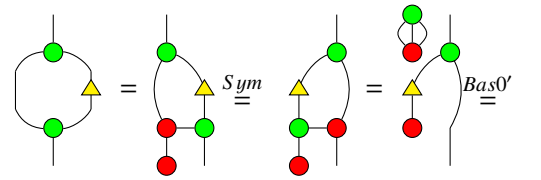

□

Lemma 5.20

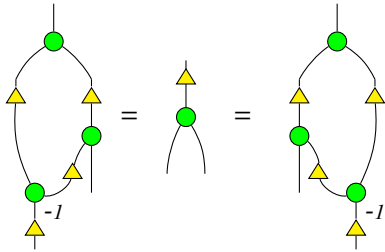

(6)

Proof:

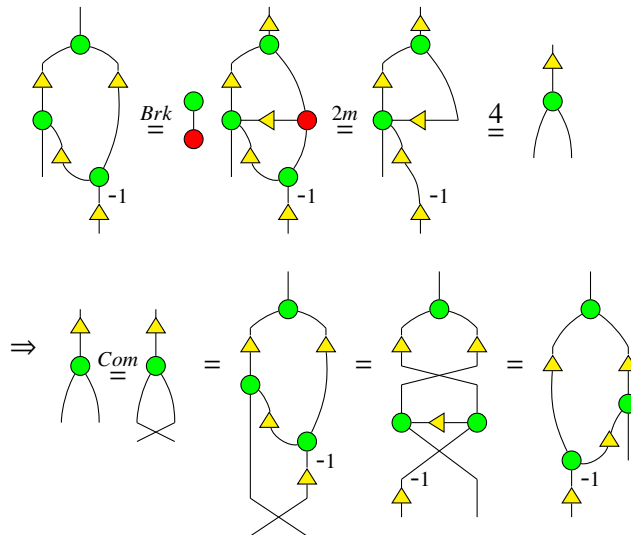

□

Lemma 5.21

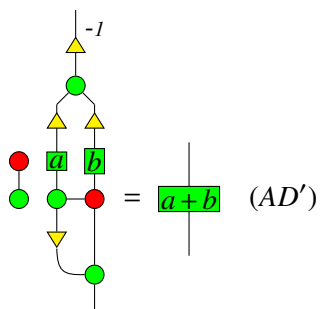

Proof: If $b \neq 0$, then

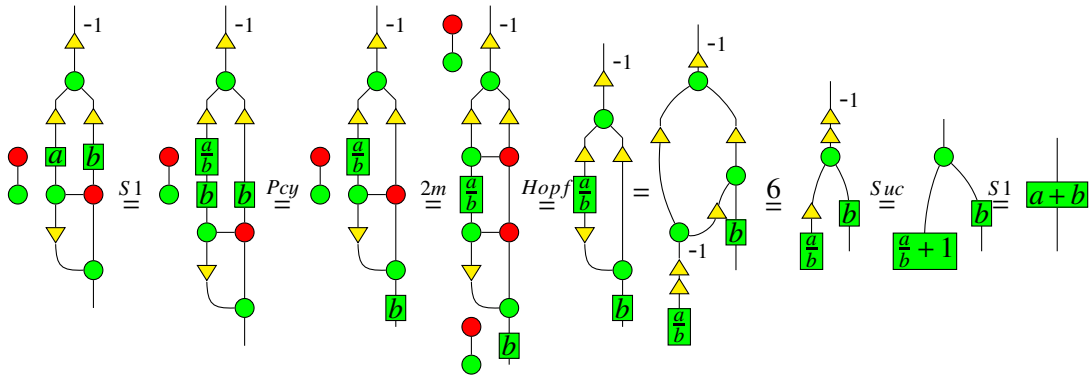

If $b = 0$, then

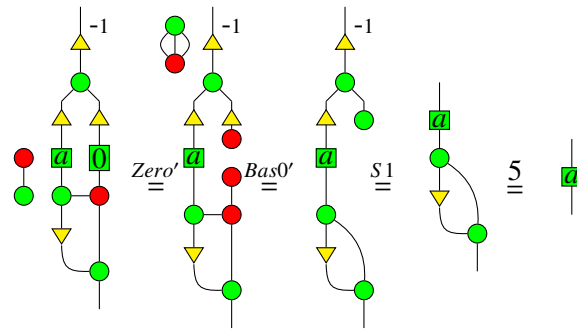

□

Proposition 5.22

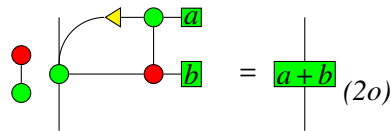

Proof:

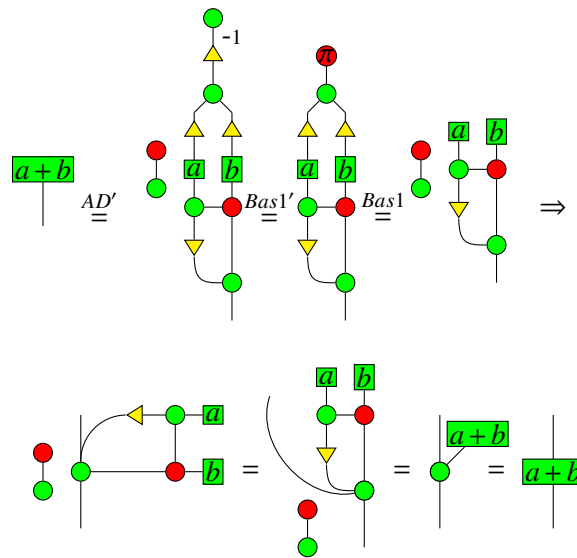

□

Proposition 5.23  = $\pi(2h)$

Proof:

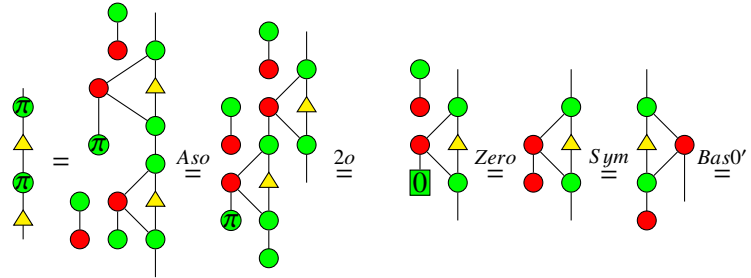

(2h) follows immediately. □

Clearly, (2h) is equivalent to $\Delta^{-1} = \begin{array}{c} \pi \\ \Delta \\ \pi \end{array}$ (IVT).

Corollary 5.24

 $\stackrel{-1}{=} \begin{array}{c} \Delta \\ \pi \end{array}$ (7)

Proof:

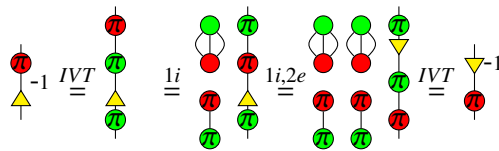

□

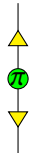
Proposition 5.25  = $\begin{array}{c} \pi \\ \Delta \end{array}$ (2d)

Proof:

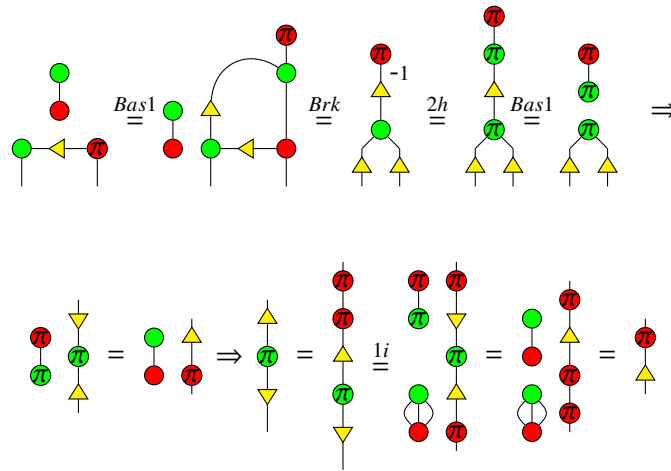

□

Lemma 5.26

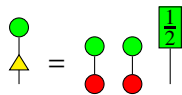

(8)

Proof:

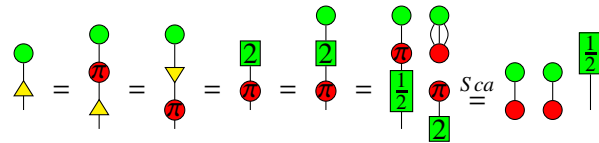

□

Lemma 5.27

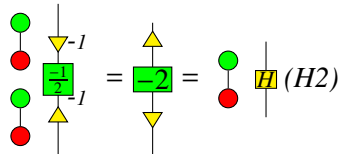

Proof:

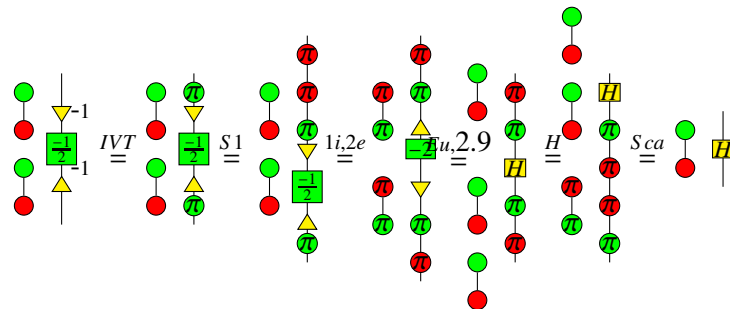

□

Lemma 5.28

Proof:

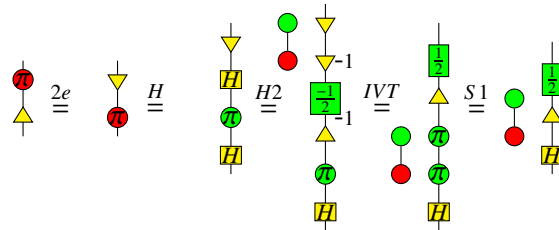

□

Proposition 5.29

Proof:

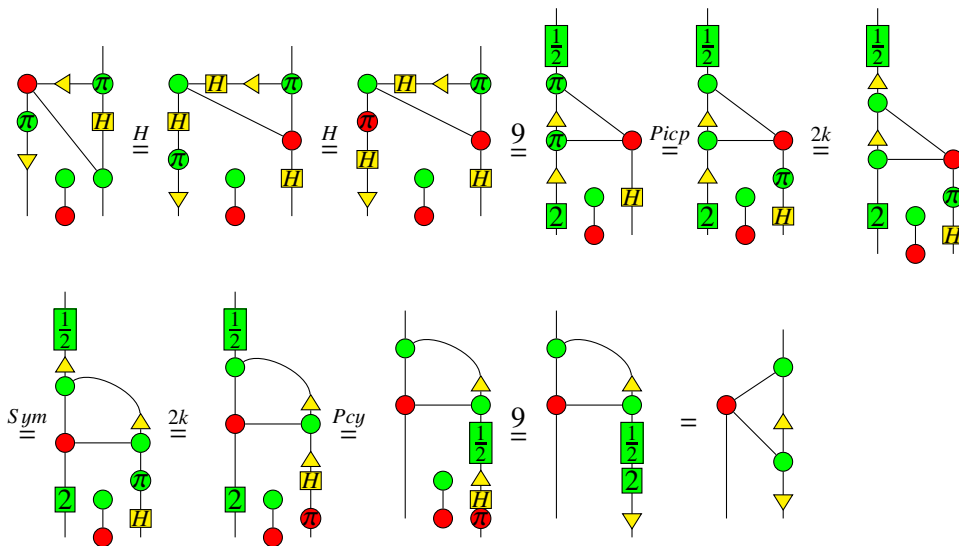

□

Proof of Theorem 4.1

For simplicity, we use the following notation.

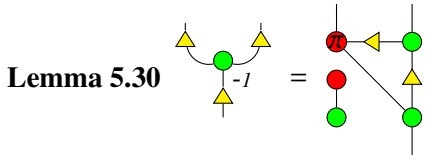
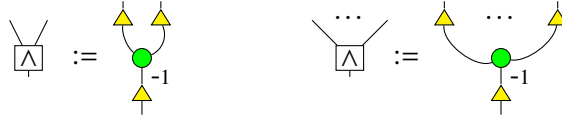

Proof:

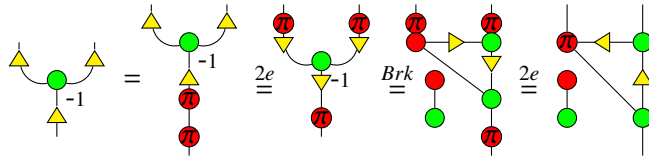

□

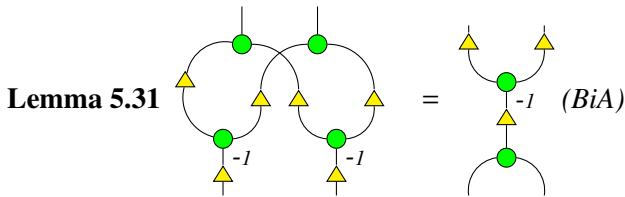

Proof:

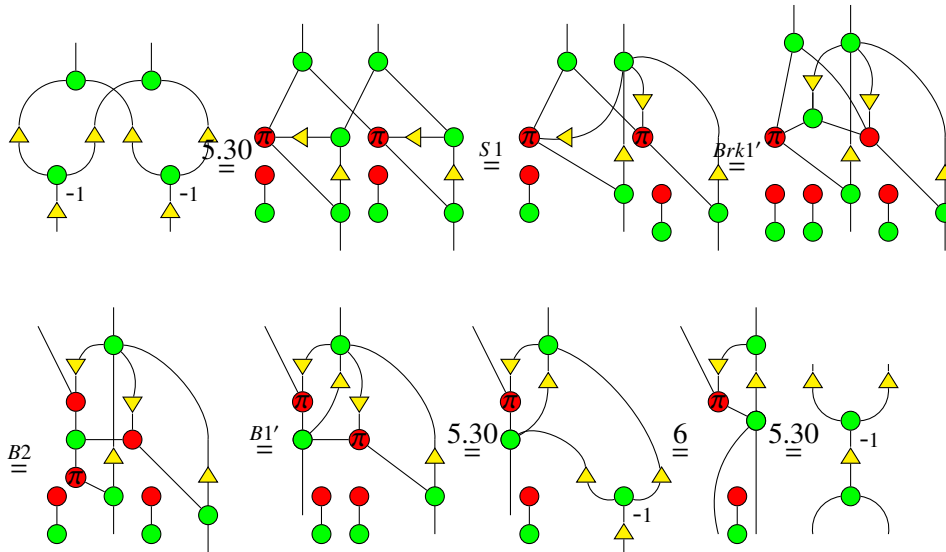

□

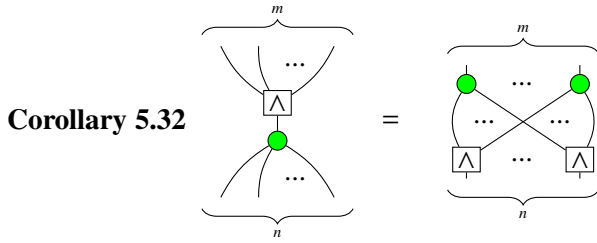

This can be proved by induction, see (L1) in [18].

Note that



Proof:

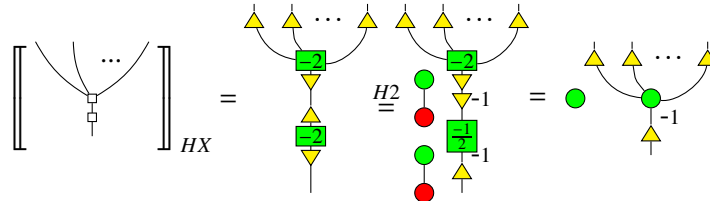

□

Then it is clear that the ZH rule (BA2) follows directly from equation 10 and Corollary 5.32.

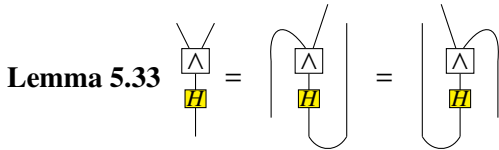

Proof:

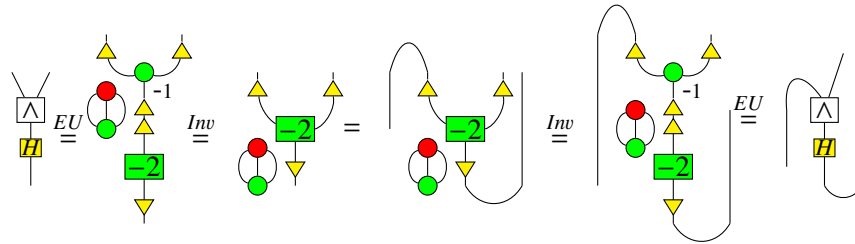

The other equality can be obtained by symmetry.

□

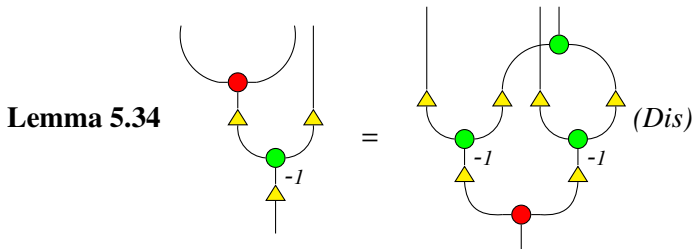

Proof:

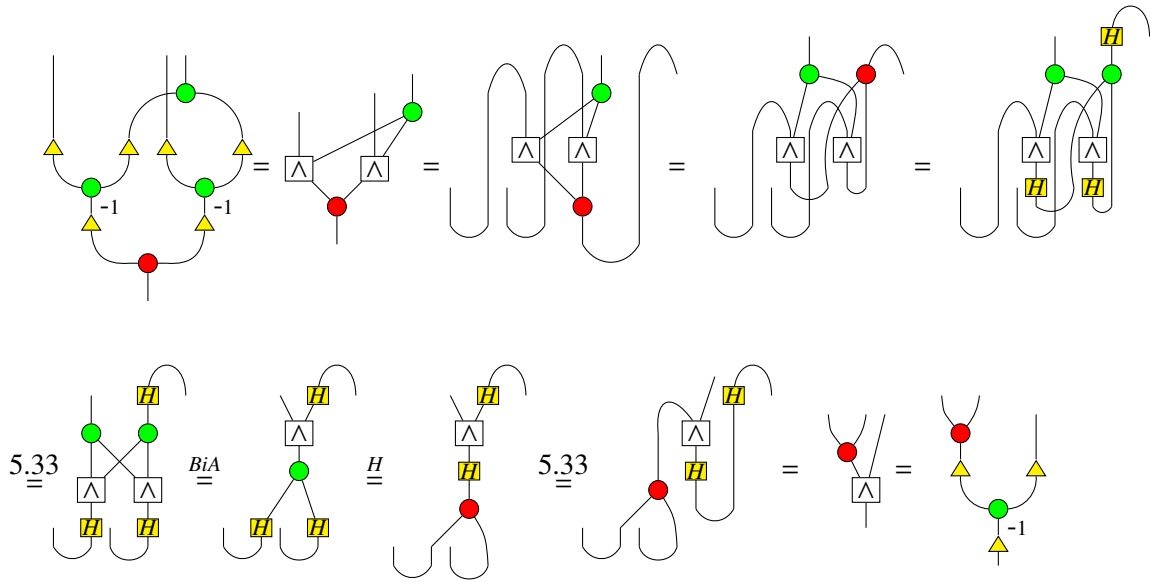

□

Corollary 5.35

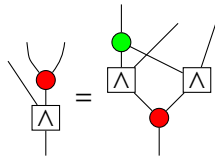

Proof:

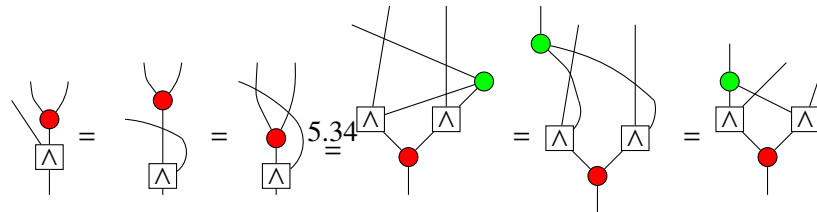

□

Lemma 5.36

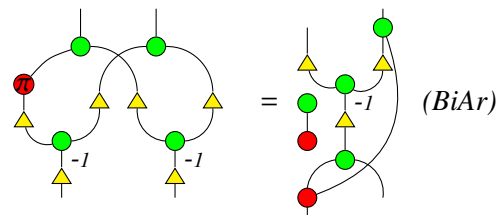

Proof:

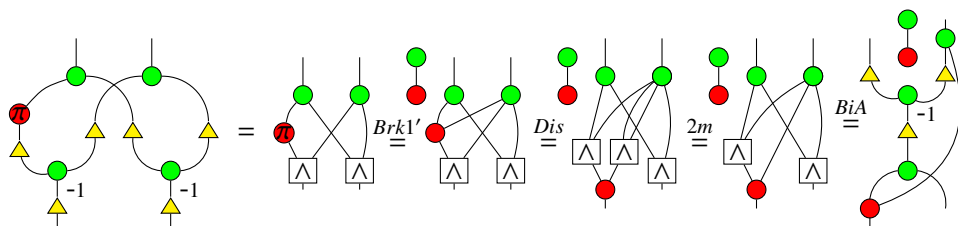

□

Proposition 5.37 (Derivation of (HS1))

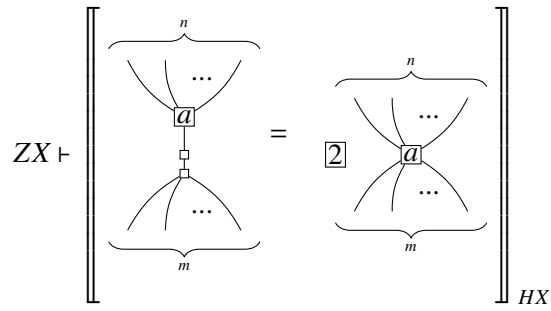

Proof:

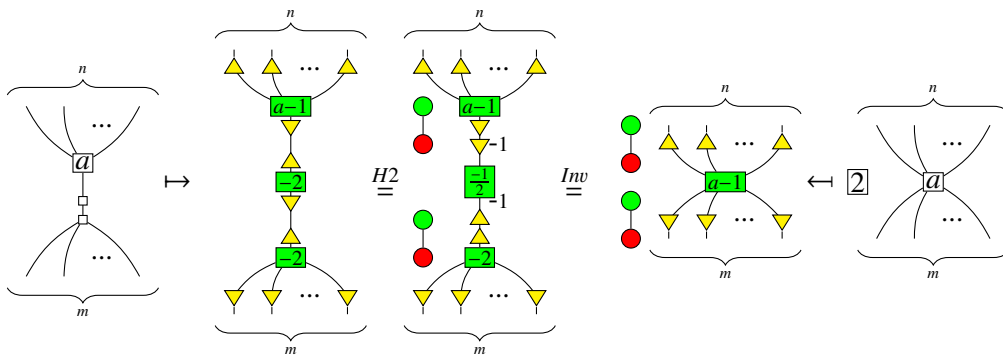

□

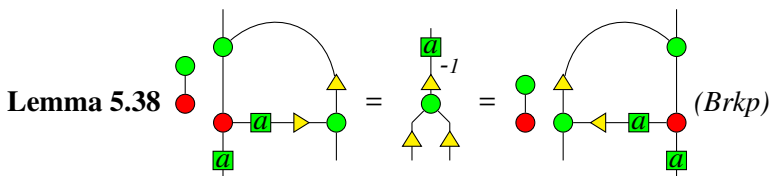

Proof:

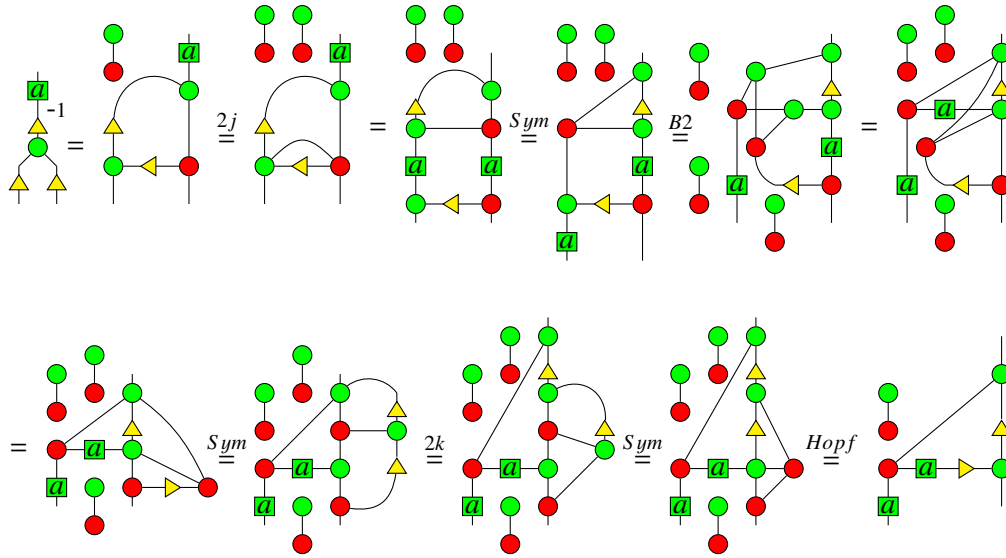

Therefore,

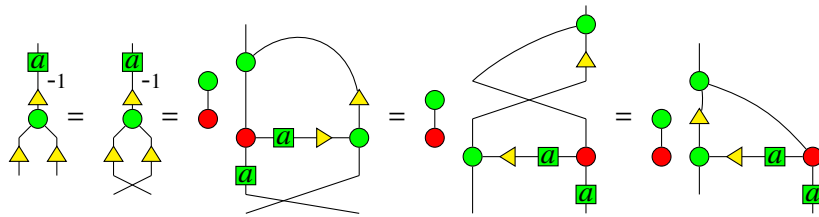

□

Proposition 5.39 (Derivation of (A))

$$ZX \vdash \left[\begin{array}{c} \text{circle with dot} \\ \text{box } a \quad \text{box } b \\ \text{circle} \end{array} \right] = \left[\begin{array}{c} \text{box } \frac{a+b}{2} \\ \text{circle} \end{array} \right]_{HX}$$

Proof: First we have

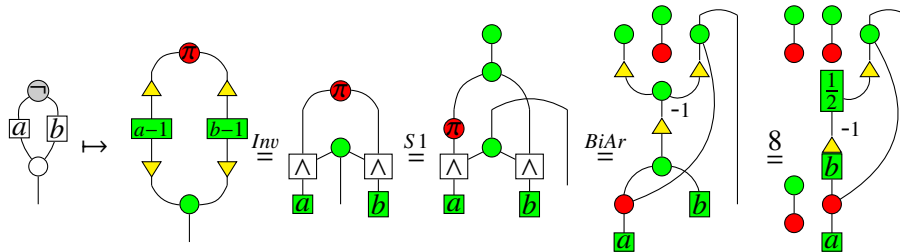

If $b = 0$, then

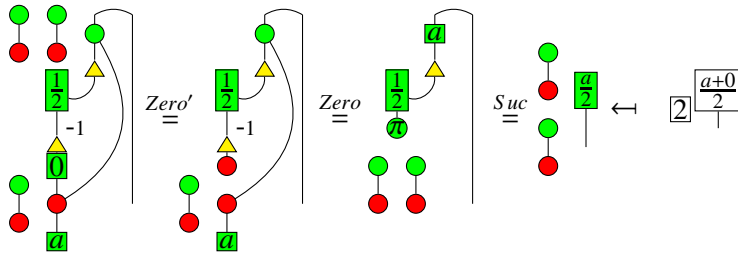

If $b \neq 0$, then we have

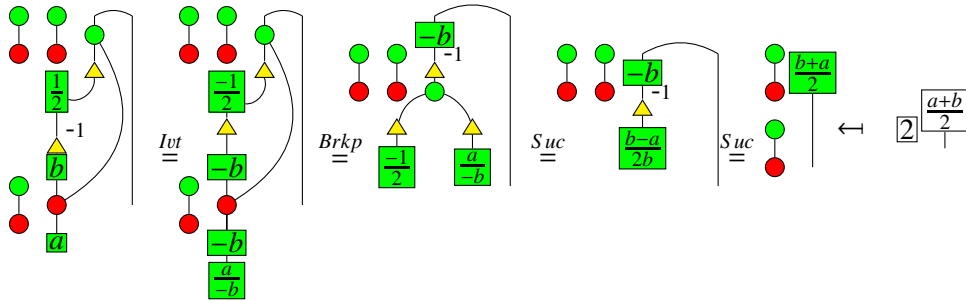

□

Proposition 5.40 (Derivation of (I))

$$ZX \vdash \left[\begin{array}{c} \circ \\ | \\ \square \\ | \\ \circ \end{array} \right] = \left[\begin{array}{c} \circ \\ | \\ \square \quad \square \\ | \\ \circ \end{array} \right]_{HX}$$

Proof:

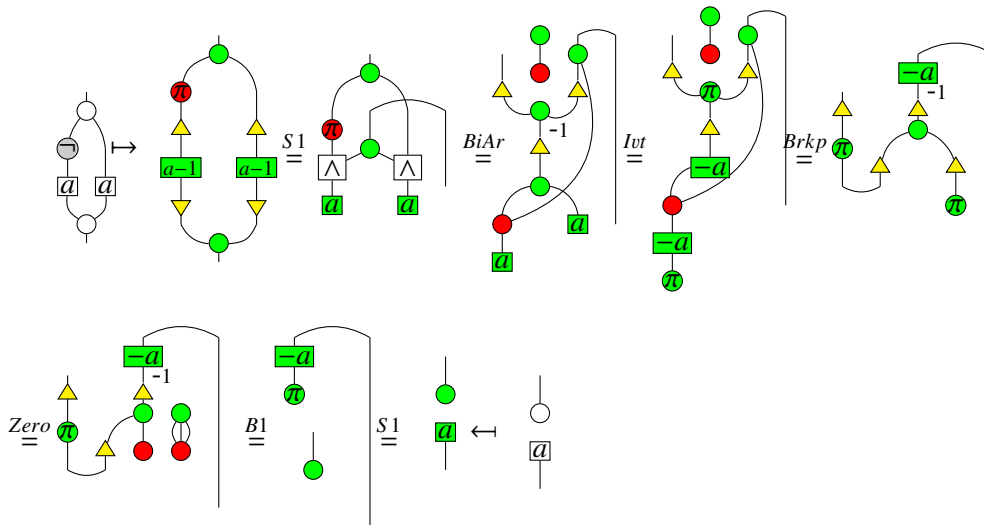

□

Proposition 5.41 (Derivation of (O))

$$ZX \vdash \boxed{2} \Bigg| \begin{array}{c} \text{Diagram 1} \\ \text{Diagram 2} \end{array} \Bigg|_{HX}$$

Proof:

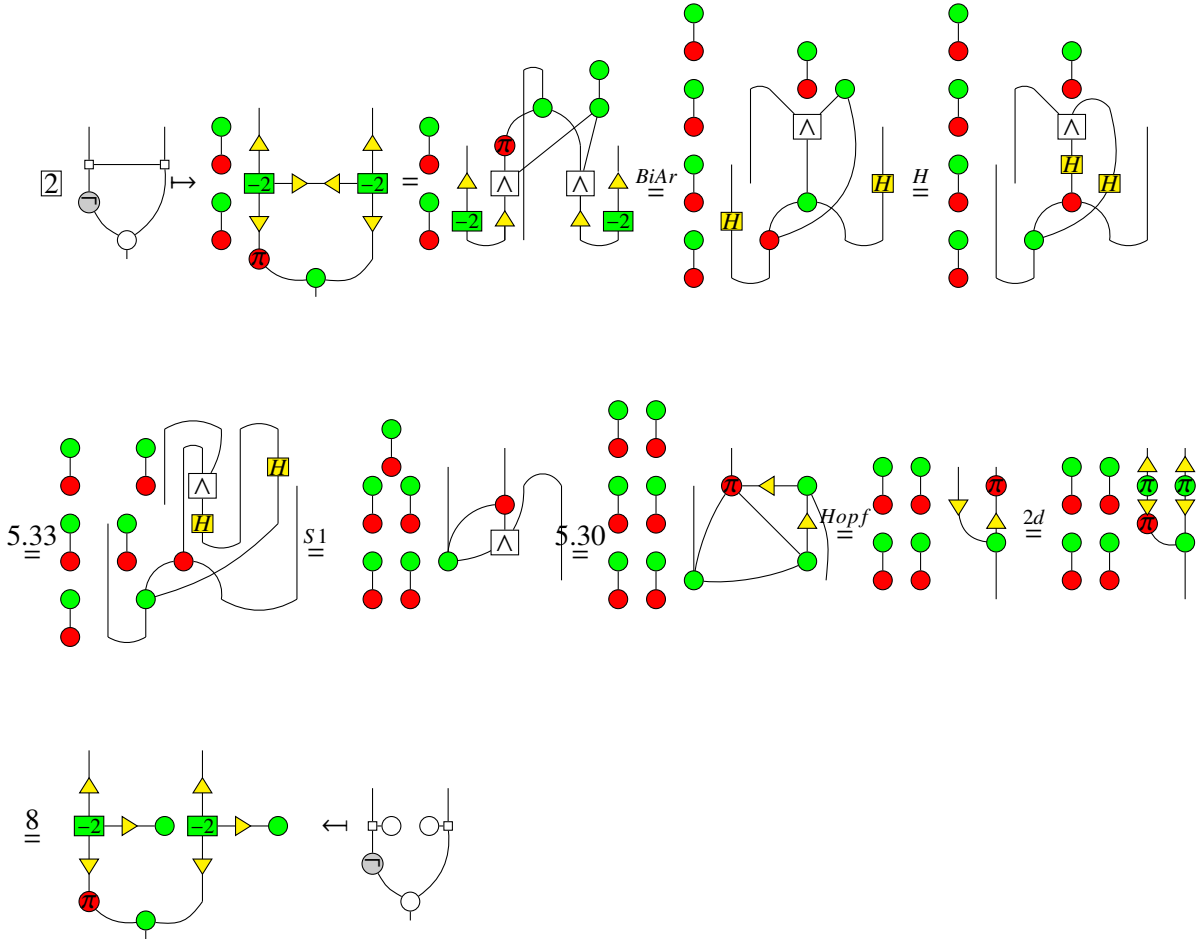

□