

ARM® Cortex®-A53 MPCore Processor

Revision: r0p2

Technical Reference Manual



ARM Cortex-A53 MPCore Processor

Technical Reference Manual

Copyright © 2013-2014 ARM. All rights reserved.

Release Information

The following changes have been made to this book.

Change history			
Date	Issue	Confidentiality	Change
09 August 2013	A	Confidential	Release for r0p0
05 November 2013	B	Confidential	Release for r0p1
10 January 2014	C	Confidential	Release for r0p2
14 February 2014	D	Non-Confidential	Second release for r0p2

Proprietary Notice

Words and logos marked with ® or ™ are registered trademarks or trademarks of ARM® in the EU and other countries, except as otherwise stated below in this proprietary notice. Other brands and names mentioned herein may be the trademarks of their respective owners.

Neither the whole nor any part of the information contained in, or the product described in, this document may be adapted or reproduced in any material form except with the prior written permission of the copyright holder.

The product described in this document is subject to continuous developments and improvements. All particulars of the product and its use contained in this document are given by ARM in good faith. However, all warranties implied or expressed, including but not limited to implied warranties of merchantability, or fitness for purpose, are excluded.

This document is intended only to assist the reader in the use of the product. ARM shall not be liable for any loss or damage arising from the use of any information in this document, or any error or omission in such information, or any incorrect use of the product.

Where the term ARM is used it means “ARM or any of its subsidiaries as appropriate”.

Confidentiality Status

This document is Non-Confidential. The right to use, copy and disclose this document may be subject to license restrictions in accordance with the terms of the agreement entered into by ARM and the party that ARM delivered this document to.

Product Status

The information in this document is final, that is for a developed product.

Web Address

<http://www.arm.com>

Contents

ARM Cortex-A53 MPCore Processor Technical Reference Manual

	Preface	
	About this book	vii
	Feedback	xi
Chapter 1	Introduction	
	1.1 About the Cortex-A53 processor	1-2
	1.2 Compliance	1-3
	1.3 Features	1-5
	1.4 Interfaces	1-6
	1.5 Implementation options	1-7
	1.6 Test features	1-9
	1.7 Product documentation and design flow	1-10
	1.8 Product revisions	1-12
Chapter 2	Functional Description	
	2.1 About the Cortex-A53 processor functions	2-2
	2.2 Interfaces	2-7
	2.3 Clocking and resets	2-9
	2.4 Power management	2-16
Chapter 3	Programmers Model	
	3.1 About the programmers model	3-2
	3.2 ARMv8-A architecture concepts	3-4
Chapter 4	System Control	
	4.1 About system control	4-2

	4.2	AArch64 register summary	4-3
	4.3	AArch64 register descriptions	4-14
	4.4	AArch32 register summary	4-135
	4.5	AArch32 register descriptions	4-157
Chapter 5		Memory Management Unit	
	5.1	About the MMU	5-2
	5.2	TLB organization	5-3
	5.3	TLB match process	5-4
	5.4	External aborts	5-5
Chapter 6		Level 1 Memory System	
	6.1	About the L1 memory system	6-2
	6.2	Cache behavior	6-3
	6.3	Support for v8 memory types	6-6
	6.4	L1 Instruction memory system	6-7
	6.5	L1 Data memory system	6-9
	6.6	Data prefetching	6-12
	6.7	Direct access to internal memory	6-13
Chapter 7		Level 2 Memory System	
	7.1	About the L2 memory system	7-2
	7.2	Snoop Control Unit	7-3
	7.3	ACE master interface	7-6
	7.4	CHI master interface	7-13
	7.5	Additional memory attributes	7-17
	7.6	Optional integrated L2 cache	7-18
	7.7	ACP	7-19
Chapter 8		Cache Protection	
	8.1	Cache protection behavior	8-2
	8.2	Error reporting	8-4
Chapter 9		Generic Interrupt Controller CPU Interface	
	9.1	About the GIC CPU Interface	9-2
	9.2	GIC programmers model	9-3
Chapter 10		Generic Timer	
	10.1	About the Generic Timer	10-2
	10.2	Generic Timer functional description	10-3
	10.3	Generic Timer register summary	10-4
Chapter 11		Debug	
	11.1	About debug	11-2
	11.2	Debug register interfaces	11-4
	11.3	AArch64 debug register summary	11-6
	11.4	AArch64 debug register descriptions	11-8
	11.5	AArch32 debug register summary	11-15
	11.6	AArch32 debug register descriptions	11-17
	11.7	Memory-mapped register summary	11-21
	11.8	Memory-mapped register descriptions	11-25
	11.9	Debug events	11-36
	11.10	External debug interface	11-37
	11.11	ROM table	11-41
Chapter 12		Performance Monitor Unit	
	12.1	About the PMU	12-2
	12.2	PMU functional description	12-3

12.3	AArch64 PMU register summary	12-5
12.4	AArch64 PMU register descriptions	12-7
12.5	AArch32 PMU register summary	12-14
12.6	AArch32 PMU register descriptions	12-16
12.7	Memory-mapped register summary	12-23
12.8	Memory-mapped register descriptions	12-26
12.9	Events	12-36
12.10	Interrupts	12-40
12.11	Exporting PMU events	12-41
Chapter 13	Embedded Trace Macrocell	
13.1	About the ETM	13-2
13.2	ETM trace unit generation options and resources	13-3
13.3	ETM trace unit functional description	13-5
13.4	Reset	13-7
13.5	Modes of operation and execution	13-8
13.6	ETM trace unit register interfaces	13-9
13.7	ETM register summary	13-10
13.8	ETM register descriptions	13-13
13.9	Interaction with debug and performance monitoring unit	13-76
Chapter 14	Cross Trigger	
14.1	About the cross trigger	14-2
14.2	Trigger inputs and outputs	14-3
14.3	Cortex-A53 CTM	14-4
14.4	Cross trigger register summary	14-5
14.5	Cross trigger register descriptions	14-8
Appendix A	Signal Descriptions	
A.1	About the signal descriptions	A-2
A.2	Clock signals	A-3
A.3	Reset signals	A-4
A.4	Configuration signals	A-5
A.5	Generic Interrupt Controller signals	A-6
A.6	Generic Timer signals	A-8
A.7	Power management signals	A-9
A.8	L2 error signals	A-11
A.9	ACE and CHI interface signals	A-12
A.10	CHI interface signals	A-13
A.11	ACE interface signals	A-17
A.12	ACP interface signals	A-22
A.13	External debug interface	A-25
A.14	ATB interface signals	A-28
A.15	Miscellaneous ETM trace unit signals	A-29
A.16	CTI interface signals	A-30
A.17	PMU interface signals	A-31
A.18	DFT and MBIST interface signals	A-32
Appendix B	Cortex-A53 Processor AArch32 unpredictable Behaviors	
B.1	Use of R15 by Instruction	B-3
B.2	unpredictable instructions within an IT Block	B-4
B.3	Load/Store accesses crossing page boundaries	B-5
B.4	ARMv8 Debug unpredictable behaviors	B-6
B.5	Other unpredictable behaviors	B-11
Appendix C	Revisions	

Preface

This preface introduces the *ARM® Cortex®-A53 MPCore Processor Technical Reference Manual*. It contains the following sections:

- *About this book on page vii.*
- *Feedback on page xi.*

About this book

This book is for the Cortex-A53 MPCore processor. This is a cluster device that has between one and four cores.

Product revision status

The *mpn* identifier indicates the revision status of the product described in this book, for example, r1p2, where:

rm	Identifies the major revision of the product, for example, r1.
pn	Identifies the minor revision or modification status of the product, for example, p2.

Intended audience

This book is written for system designers, system integrators, and programmers who are designing or programming a *System-on-Chip* (SoC) that uses the Cortex-A53 processor.

Using this book

This book is organized into the following chapters:

Chapter 1 *Introduction*

Read this for an introduction to the Cortex-A53 processor and descriptions of the major features.

Chapter 2 *Functional Description*

Read this for a description of the functionality of the Cortex-A53 processor.

Chapter 3 *Programmers Model*

Read this for a description of the programmers model.

Chapter 4 *System Control*

Read this for a description of the system registers and programming information.

Chapter 5 *Memory Management Unit*

Read this for a description of the *Memory Management Unit* (MMU).

Chapter 6 *Level 1 Memory System*

Read this for a description of the *Level 1* (L1) memory system.

Chapter 7 *Level 2 Memory System*

Read this for a description of the *Level 2* (L2) memory system.

Chapter 8 *Cache Protection*

Read this for a description of the cache protection.

Chapter 9 *Generic Interrupt Controller CPU Interface*

Read this for a description of the *Generic Interrupt Controller* (GIC) CPU Interface.

Chapter 10 *Generic Timer*

Read this for a description of the Generic Timer.

Chapter 11 *Debug*

Read this for a description of the debug registers and shows examples of how to use them.

Chapter 12 *Performance Monitor Unit*

Read this for a description of the *Performance Monitor Unit* (PMU).

Chapter 13 *Embedded Trace Macrocell*

Read this for a description of the *Embedded Trace Macrocell* (ETM) for the Cortex-A53 processor.

Chapter 14 *Cross Trigger*

Read this for a description of the cross trigger interfaces.

Appendix A *Signal Descriptions*

Read this for a description of the signals in the Cortex-A53 processor.

Appendix B *Cortex-A53 Processor AArch32 unpredictable Behaviors*

Read this for a description of specific Cortex-A53 processor UNPREDICTABLE behaviors.

Appendix C *Revisions*

Read this for a description of the technical changes between released issues of this book.

Glossary

The *ARM® Glossary* is a list of terms used in ARM documentation, together with definitions for those terms. The *ARM® Glossary* does not contain terms that are industry standard unless the ARM meaning differs from the generally accepted meaning.

See *ARM® Glossary*, <http://infocenter.arm.com/help/topic/com.arm.doc.aeg0014-/index.html>.

Conventions

This book uses the conventions that are described in:

- *Typographical conventions*.
- *Timing diagrams* on page ix.
- *Signals* on page ix.

Typographical conventions

The following table describes the typographical conventions:

Typographical conventions

Style	Purpose
<i>italic</i>	Introduces special terminology, denotes cross-references, and citations.
bold	Highlights interface elements, such as menu names. Denotes signal names. Also used for terms in descriptive lists, where appropriate.
monospace	Denotes text that you can enter at the keyboard, such as commands, file and program names, and source code.

Typographical conventions (continued)

Style	Purpose
<code><u>monospace</u></code>	Denotes a permitted abbreviation for a command or option. You can enter the underlined text instead of the full command or option name.
<code>monospace <i>italic</i></code>	Denotes arguments to monospace text where the argument is to be replaced by a specific value.
<code>monospace bold</code>	Denotes language keywords when used outside example code.
<code><and></code>	Encloses replaceable terms for assembler syntax where they appear in code or code fragments. For example: <code>MRC p15, 0 <Rd>, <CRn>, <CRm>, <Opcode_2></code>
SMALL CAPITALS	Used in body text for a few terms that have specific technical meanings, that are defined in the <i>ARM® Glossary</i> . For example, IMPLEMENTATION DEFINED, IMPLEMENTATION SPECIFIC, UNKNOWN, and UNPREDICTABLE.

Timing diagrams

The figure [Key to timing diagram conventions](#) explains the components used in timing diagrams. Variations, when they occur, have clear labels. You must not assume any timing information that is not explicit in the diagrams.

Shaded bus and signal areas are UNDEFINED, so the bus or signal can assume any value within the shaded area at that time. The actual level is unimportant and does not affect normal operation.

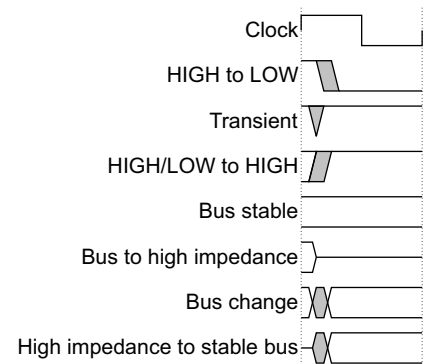

Key to timing diagram conventions

Signals

The signal conventions are:

Signal level The level of an asserted signal depends on whether the signal is active-HIGH or active-LOW. Asserted means:

- HIGH for active-HIGH signals.
- LOW for active-LOW signals.

Lowercase n At the start or end of a signal name denotes an active-LOW signal.

Additional reading

This section lists publications by ARM and by third parties.

See Infocenter, <http://infocenter.arm.com>, for access to ARM documentation.

ARM publications

This book contains information that is specific to this product. See the following documents for other relevant information:

- *ARM® Architecture Reference Manual ARMv7-A and ARMv7-R edition* (ARM DDI 0406).
- *ARM® Architecture Reference Manual ARMv8, for ARMv8-A architecture profile* (ARM DDI 0487).
- *ARM® Cortex®-A53 MPCore Processor Advanced SIMD and Floating-point Extension Technical Reference Manual* (ARM DDI 0502).
- *ARM® Cortex®-A Series Programmer's Guide* (ARM DEN 0013).
- *ARM® AMBA® AXI and ACE Protocol Specification AXI3, AXI4, and AXI4-Lite, ACE and ACE-Lite* (ARM IHI 0022).
- *ARM® AMBA® APB Protocol Specification* (ARM IHI 0024).
- *ARM® CoreSight™ Architecture Specification* (ARM IHI 0029).
- *ARM® Debug Interface Architecture Specification, ADIV5.0 to ADIV5.2* (ARM IHI 0031).
- *ARM® AMBA® 4 ATB Protocol Specification* (ARM IHI 0032).
- *ARM® Generic Interrupt Controller Architecture Specification* (ARM IHI 0048).
- *ARM® ETM™ Architecture Specification, ETMv4* (ARM IHI 0064).

The following confidential books are only available to licensees:

- *ARM® Cortex™-A53 MPCore Processor Cryptography Extension Technical Reference Manual* (ARM DDI 0501).
- *ARM® Cortex®-A53 MPCore Processor Configuration and Sign-off Guide* (ARM DII 0281).
- *ARM® Cortex®-A53 MPCore Processor Integration Manual* (ARM DIT 0036).
- *ARM® AMBA® 5 CHI Protocol Specification* (ARM IHI 0050).
- *ARMv8 Debug Implementation Envelope*
- *ARMv8 AArch32 UNPREDICTABLE behaviors*

Other publications

This section lists relevant documents published by third parties:

- *ANSI/IEEE Std 754-2008, IEEE Standard for Binary Floating-Point Arithmetic.*

———— **Note** —————

ARM floating-point terminology is largely based on the earlier ANSI/IEEE Std 754-1985 issue of the standard. See the *ARM® Architecture Reference Manual ARMv8, for ARMv8-A architecture profile* for more information.

Feedback

ARM welcomes feedback on this product and its documentation.

Feedback on this product

If you have any comments or suggestions about this product, contact your supplier and give:

- The product name.
- The product revision or version.
- An explanation with as much information as you can provide. Include symptoms and diagnostic procedures if appropriate.

Feedback on content

If you have comments on content then send an e-mail to errata@arm.com. Give:

- The title.
- The number, ARM DDI 0500D.
- The page numbers to which your comments apply.
- A concise explanation of your comments.

ARM also welcomes general suggestions for additions and improvements.

———— **Note** —————

ARM tests the PDF only in Adobe Acrobat and Acrobat Reader, and cannot guarantee the quality of the represented document when used with any other PDF reader.

Chapter 1

Introduction

This chapter introduces the Cortex-A53 processor and its features. It contains the following sections:

- *About the Cortex-A53 processor* on page 1-2.
- *Compliance* on page 1-3.
- *Features* on page 1-5.
- *Interfaces* on page 1-6.
- *Implementation options* on page 1-7.
- *Test features* on page 1-9.
- *Product documentation and design flow* on page 1-10.
- *Product revisions* on page 1-12.

1.1 About the Cortex-A53 processor

The Cortex-A53 processor is a mid-range, low-power processor that implements the ARMv8-A architecture. The Cortex-A53 processor has one to four cores, each with an L1 memory system and a single shared L2 cache.

Figure 1-1 shows an example of a Cortex-A53 MPCore configuration with four cores and either an ACE or a CHI interface.

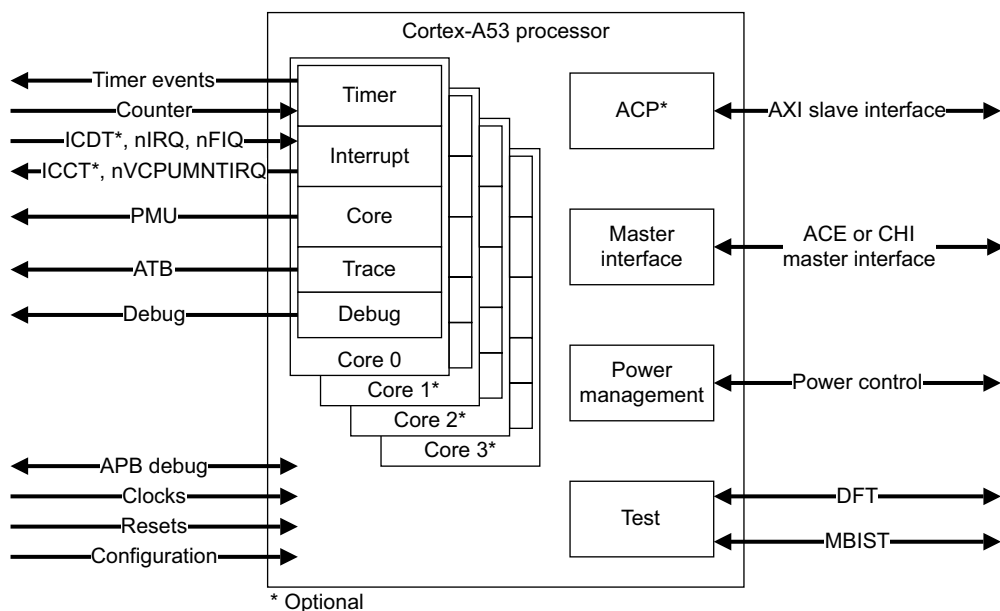

Figure 1-1 Example Cortex-A53 processor configuration

See [About the Cortex-A53 processor functions on page 2-2](#) for more information about the functional components.

1.2 Compliance

The Cortex-A53 processor complies with, or implements, the specifications described in:

- [ARM architecture](#).
- [Interconnect architecture](#).
- [Generic Interrupt Controller architecture on page 1-4](#).
- [Generic Timer architecture on page 1-4](#).
- [Debug architecture on page 1-4](#).
- [Embedded Trace Macrocell architecture on page 1-4](#).

This TRM complements architecture reference manuals, architecture specifications, protocol specifications, and relevant external standards. It does not duplicate information from these sources.

1.2.1 ARM architecture

The Cortex-A53 processor implements the ARMv8-A architecture. This includes:

- Support for both AArch32 and AArch64 Execution states.
- Support for all exception levels, EL0, EL1, EL2, and EL3, in each execution state.
- The A32 instruction set, previously called the ARM instruction set.
- The T32 instruction set, previously called the Thumb instruction set.
- The A64 instruction set.

The Cortex-A53 processor supports the following architecture extensions:

- Optional Advanced SIMD and Floating-point Extension for integer and floating-point vector operations.

———— **Note** —————

- The Advanced SIMD architecture, its associated implementations, and supporting software, are commonly referred to as NEON technology.
- To perform floating-point operations, you must implement the Advanced SIMD and Floating-point Extension. There is no software API library for floating-point in the ARMv8-A architecture.
- You cannot implement floating-point without Advanced SIMD.

- Optional ARMv8 Cryptography Extensions.

———— **Note** —————

You cannot implement the Cryptography Extensions without Advanced SIMD and Floating-point.

See the *ARM® Architecture Reference Manual ARMv8, for ARMv8-A architecture profile* for more information.

1.2.2 Interconnect architecture

The Cortex-A53 bus interface natively supports one of:

- AMBA 4 ACE bus architecture. See the *ARM® AMBA® AXI and ACE Protocol Specification AXI3, AXI4, and AXI4-Lite, ACE and ACE-Lite*.
- AMBA 5 CHI bus architecture. See the *ARM® AMBA® 5 CHI Protocol Specification*.

1.2.3 Generic Interrupt Controller architecture

The Cortex-A53 processor implements the *Generic Interrupt Controller (GIC) v4* architecture. The Cortex-A53 processor includes only the GIC CPU Interface. See the *ARM® Generic Interrupt Controller Architecture Specification*.

1.2.4 Generic Timer architecture

The Cortex-A53 processor implements the ARM Generic Timer architecture. See the *ARM® Architecture Reference Manual ARMv8, for ARMv8-A architecture profile*.

1.2.5 Debug architecture

The Cortex-A53 processor implements the ARMv8 Debug architecture. The CoreSight *Cross Trigger Interface (CTI)* enables the debug logic, the *Embedded Trace Macrocell (ETM)*, and the *Performance Monitor Unit (PMU)*, to interact with each other and with other CoreSight components. For more information, see the:

- *ARM® CoreSight™ Architecture Specification*.
- *ARM® Architecture Reference Manual ARMv8, for ARMv8-A architecture profile*.

1.2.6 Embedded Trace Macrocell architecture

The Cortex-A53 processor implements the ETMv4 architecture. See the *ARM® ETM™ Architecture Specification, ETMv4*.

1.3 Features

The Cortex-A53 processor includes the following features:

- Full implementation of the ARMv8-A architecture instruction set with the architecture options listed in [ARM architecture on page 1-3](#).
- In-order pipeline with symmetric dual-issue of most instructions.
- Harvard *Level 1* (L1) memory system with a *Memory Management Unit* (MMU).
- *Level 2* (L2) memory system providing cluster memory coherency, optionally including an L2 cache.

1.4 Interfaces

The Cortex-A53 processor has the following external interfaces:

- Memory interface that implements either an ACE or CHI interface.
- Optional *Accelerator Coherency Port* (ACP) that implements an AXI slave interface.
- Debug interface that implements an APB slave interface.
- Trace interface that implements an ATB interface.
- CTI.
- *Design for Test* (DFT).
- *Memory Built-In Self Test* (MBIST).
- Q-channel, for power management.

See [Interfaces on page 2-7](#) for more information on each of these interfaces.

1.5 Implementation options

Table 1-1 lists the implementation options at build time for the Cortex-A53 processor.

Table 1-1 Cortex-A53 processor implementation options

Feature	Range of options
Number of cores	Up to four cores.
L1 Instruction cache size	<ul style="list-style-type: none"> • 8K. • 16K. • 32K. • 64K.
L1 Data cache size	<ul style="list-style-type: none"> • 8K. • 16K. • 32K. • 64K.
L2 cache	Included or not.
L2 cache size	<ul style="list-style-type: none"> • 128K. • 256K. • 512K. • 1024K. • 2048K.
L2 data RAM input latency	<ul style="list-style-type: none"> • 1 cycle. • 2 cycles.
L2 data RAM output latency	<ul style="list-style-type: none"> • 2 cycles. • 3 cycles.
SCU-L2 cache protection	Included or not.
Advanced SIMD and Floating-point Extension	Included or not.
Cryptography Extension	Included or not.
CPU cache protection ^a	Included or not.
AMBA 5 CHI or AMBA 4 ACE interface	<ul style="list-style-type: none"> • AMBA 5 CHI. • AMBA 4 ACE.
<i>Accelerator Coherency Port (ACP)</i> ^b	Included or not.
v7 or v8 Debug memory map	<ul style="list-style-type: none"> • v8 Debug memory map. • v7 Debug memory map.

a. Not implemented if the L2 cache is implemented and SCU-L2 cache protection is not implemented.

b. Not implemented if the Cortex-A53 processor does not include an L2 cache.

Note

- The L1 duplicate tags in the SCU are protected by the CPU cache protection.
- There is no option to implement floating-point without Advanced SIMD.
- There is no option to implement the Cryptography Extension without the Advanced SIMD and Floating-point Extension.

- All cores share a common L2 cache.
-

1.5.1 Processor configuration

All cores in a cluster have identical configurations, that were determined during the build configuration. These configurations cannot be changed by software:

- Either all of the cores have L1 cache protection, or none have.
- Either all of the cores have Advanced SIMD and Floating-point Extensions, or none have.
- Either all of the cores have Cryptography Extensions, or none have.
- All cores must have the same size L1 caches as each other.

1.6 Test features

The Cortex-A53 processor provides test signals that enable the use of both ATPG and MBIST to test the processor and its memory arrays. See [Appendix A Signal Descriptions](#) for more information.

1.7 Product documentation and design flow

This section describes the Cortex-A53 processor books and how they relate to the design flow in:

- [Documentation](#).
- [Design flow on page 1-11](#).

See [Additional reading on page ix](#) for more information about the books described in this section. For information on the relevant architectural standards and protocols, see [Compliance on page 1-3](#).

1.7.1 Documentation

The Cortex-A53 processor documentation is as follows:

Technical Reference Manual

The *Technical Reference Manual* (TRM) describes the functionality and the effects of functional options on the behavior of the Cortex-A53 processor. It is required at all stages of the design flow. The choices made in the design flow can mean that some behavior described in the TRM is not relevant. If you are programming the Cortex-A53 processor then contact:

- The implementer to determine:
 - The build configuration of the implementation.
 - What integration, if any, was performed before implementing the Cortex-A53 processor.
- The integrator to determine the pin configuration of the device that you are using.

There are separate TRMs for:

- The optional Advanced SIMD and Floating-point Extension.
- The optional Cryptography Extension.

Configuration and Sign-off Guide

The *Configuration and Sign-off Guide* (CSG) describes:

- The available build configuration options and related issues in selecting them.
- How to configure the *Register Transfer Level* (RTL) source files with the build configuration options.
- How to integrate RAM arrays.
- How to run test vectors.
- The processes to sign off the configured design.

The ARM product deliverables include reference scripts and information about using them to implement your design. Reference methodology flows supplied by ARM are example reference implementations. Contact your EDA vendor for EDA tool support.

The CSG is a confidential book that is only available to licensees.

Integration Manual

The *Integration Manual* (IM) describes how to integrate the Cortex-A53 processor into a SoC. It includes a description of the pins that the integrator must tie off to configure the processor. Some of the integration is affected by the configuration options used when implementing the Cortex-A53 processor.

The IM is a confidential book that is only available to licensees.

1.7.2 Design flow

The Cortex-A53 processor is delivered as synthesizable RTL. Before it can be used in a product, it must go through the following process:

- Implementation** The implementer configures and synthesizes the RTL to produce a hard macrocell. This includes integrating RAMs into the design.
- Integration** The integrator connects the macrocell into a SoC. This includes connecting it to a memory system and peripherals.
- Programming** This is the last process. The system programmer develops the software required to configure and initialize the Cortex-A53 processor, and tests the required application software.

Each process:

- Can be performed by a different party.
- Can include implementation and integration choices that affect the behavior and features of the Cortex-A53 processor.

The operation of the final device depends on:

Build configuration

The implementer chooses the options that affect how the RTL source files are pre-processed. These options usually include or exclude logic that affects one or more of the area, maximum frequency, and features of the resulting macrocell.

Configuration inputs

The integrator configures some features of the Cortex-A53 processor by tying inputs to specific values. These configurations affect the start-up behavior before any software configuration is made. They can also limit the options available to the software.

Software configuration

The programmer configures the Cortex-A53 processor by programming particular values into registers. This affects the behavior of the processor.

Note

This manual refers to implementation-defined features that apply to build configuration options. Reference to a feature that is included means that the appropriate build and pin configuration options have been selected. Reference to an enabled feature means that the feature has also been configured by software.

1.8 Product revisions

This section describes the differences in functionality between product revisions.

r0p0 First release.

r0p1 There are no functional changes in this release.

r0p2 There are no functional changes in this release.

Chapter 2

Functional Description

This chapter describes the functionality of the Cortex-A53 processor. It contains the following sections:

- *About the Cortex-A53 processor functions* on page 2-2.
- *Interfaces* on page 2-7.
- *Clocking and resets* on page 2-9.
- *Power management* on page 2-16.

2.1 About the Cortex-A53 processor functions

Figure 2-1 shows a top-level functional diagram of the Cortex-A53 processor.

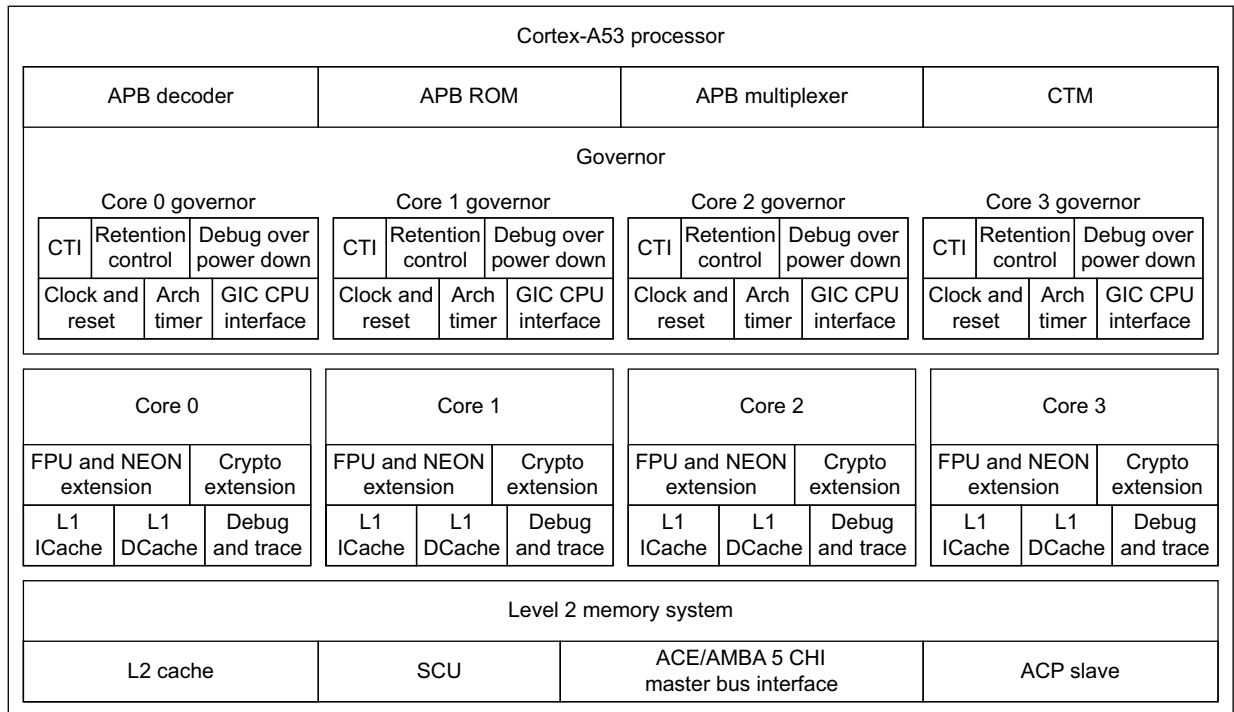

Figure 2-1 Cortex-A53 processor block diagram

The following sections describe the main Cortex-A53 processor components and their functions:

- [Instruction Fetch Unit](#).
- [Data Processing Unit](#) on page 2-3.
- [Advanced SIMD and Floating-point Extension](#) on page 2-3.
- [Cryptography Extension](#) on page 2-4.
- [Translation Lookaside Buffer](#) on page 2-4.
- [Data side memory system](#) on page 2-4.
- [L2 memory system](#) on page 2-5.
- [Cache protection](#) on page 2-6.
- [Debug and trace](#) on page 2-6.

2.1.1 Instruction Fetch Unit

The *Instruction Fetch Unit* (IFU) contains the instruction cache controller and its associated linefill buffer. The Cortex-A53 MPCore instruction cache is 2-way set associative and uses *Virtually Indexed Physically Tagged* (VIPT) cache lines holding up to 16 A32 instructions, 16 32-bit T32 instructions, 16 A64 instructions, or up to 32 16-bit T32 instructions.

The IFU cannot hold A64, A32, and T32 instructions in the same cache line. For example, if the IFU fetches both A32 and T32 instructions from the same 64 byte region of memory, that region occupies two cache lines, one for the A32 instructions and one for the T32 instructions.

The instruction cache has the following features:

- Pseudo-random cache replacement policy.

- Sequential instruction fetches.
- Instruction prefetches.
- Critical word first linefill on a cache miss.

The IFU obtains instructions from the instruction cache or from external memory and predicts the outcome of branches in the instruction stream, then passes the instructions to the *Data Processing Unit* (DPU) for processing.

If the cache protection configuration is chosen, the L1 Instruction cache data and tag RAMs are protected by parity bits. The parity bits enable any single-bit error to be detected. If an error is detected, the line is invalidated and fetched again.

Branch Target Instruction Cache

The IFU contains a single entry *Branch Target Instruction Cache* (BTIC). This stores up to two instruction cache fetches and enables the branch shadow of predicted taken branch instructions to be eliminated. The BTIC implementation is architecturally transparent, so it does not have to be flushed on a context switch.

Branch Target Address Cache

The IFU contains a 256-entry *Branch Target Address Cache* (BTAC) to predict the target address of indirect branches. The BTAC implementation is architecturally transparent, so it does not have to be flushed on a context switch.

Branch predictor

The branch predictor is a global type that uses branch history registers and a 3072-entry pattern history prediction table.

Return stack

The IFU includes an 8-entry return stack to accelerate returns from procedure calls. For each procedure call, the return address is pushed onto a hardware stack. When a procedure return is recognized, the address held in the return stack is popped, and the IFU uses it as the predicted return address. The return stack is architecturally transparent, so it does not have to be flushed on a context switch.

See [Chapter 6 Level 1 Memory System](#) for more information.

2.1.2 Data Processing Unit

The *Data Processing Unit* (DPU) holds most of the program-visible state of the processor, such as general-purpose registers and system registers. It provides configuration and control of the memory system and its associated functionality. It decodes and executes instructions, operating on data held in the registers in accordance with the ARMv8-A architecture. Instructions are fed to the DPU from the IFU. The DPU executes instructions that require data to be transferred to or from the memory system by interfacing to the *Data Cache Unit* (DCU), that manages all load and store operations.

See [Chapter 3 Programmers Model](#) and [Chapter 4 System Control](#) for more information.

2.1.3 Advanced SIMD and Floating-point Extension

The optional Advanced SIMD and Floating-point Extension implements:

- ARM NEON technology, a media and signal processing architecture that adds instructions targeted at audio, video, 3-D graphics, image, and speech processing. Advanced SIMD instructions are available in AArch64 and AArch32 states.

- The floating-point architecture includes the floating-point register file and status registers. It performs floating-point operations on the data held in the floating-point register file.

See the *ARM® Cortex®-A53 MPCore Advanced SIMD and Floating-point Extension Technical Reference Manual* for more information.

2.1.4 Cryptography Extension

The optional Cortex-A53 MPCore Cryptography Extension supports the ARMv8 Cryptography Extensions. The Cryptography Extension adds new A64, A32, and T32 instructions to Advanced SIMD that accelerate:

- *Advanced Encryption Standard* (AES) encryption and decryption.
- The *Secure Hash Algorithm* (SHA) functions SHA-1, SHA-224, and SHA-256.
- Finite field arithmetic used in algorithms such as *Galois/Counter Mode* and *Elliptic Curve Cryptography*.

See the *ARM® Cortex™-A53 MPCore Processor Cryptography Extension Technical Reference Manual* for more information.

2.1.5 Translation Lookaside Buffer

The *Translation Lookaside Buffer* (TLB) contains the main TLB and handles all translation table walk operations for the processor. TLB entries are stored inside a 512-entry, 4-way set-associative RAM.

If the cache protection configuration is implemented, the TLB RAMs are protected by parity bits. The parity bits enable any single-bit error to be detected. If an error is detected, the entry is flushed and fetched again.

See [Chapter 6 Level 1 Memory System](#) for more information.

2.1.6 Data side memory system

This section describes the following:

- [Data Cache Unit](#).
- [Store Buffer on page 2-5](#).
- [Bus Interface Unit and SCU interface on page 2-5](#).

Data Cache Unit

The *Data Cache Unit* (DCU) consists of the following sub-blocks:

- The *Level 1* (L1) data cache controller, that generates the control signals for the associated embedded tag, data, and dirty RAMs, and arbitrates between the different sources requesting access to the memory resources. The data cache is 4-way set associative and uses a *Physically Indexed Physically Tagged* (PIPT) scheme for lookup that enables unambiguous address management in the system.
- The load/store pipeline that interfaces with the DPU and main TLB.
- The system controller that performs cache and TLB maintenance operations directly on the data cache and on the instruction cache through an interface with the IFU.
- An interface to receive coherency requests from the *Snoop Control Unit* (SCU).

The data cache has the following features:

- Pseudo-random cache replacement policy.
- Streaming of sequential data because of multiple word load instructions, for example LDM, LDRD, LDP and VLDM.
- Critical word first linefill on a cache miss.

See [Chapter 6 Level 1 Memory System](#) for more information.

If the CPU cache protection configuration is implemented, the L1 Data cache tag RAMs and dirty RAMs are protected by parity bits. The L1 Data cache data RAMs are protected using *Error Correction Codes* (ECC). The ECC scheme is *Single Error Correct Double Error Detect* (SECCDED).

The DCU includes a combined local and global exclusive monitor, used by the Load-Exclusive/Store-Exclusive instructions. See the *ARM® Architecture Reference Manual ARMv8, for ARMv8-A architecture profile* for information about these instructions.

Store Buffer

The *Store Buffer* (STB) holds store operations when they have left the load/store pipeline and have been committed by the DPU. The STB can request access to the cache RAMs in the DCU, request the BIU to initiate linefills, or request the BIU to write the data out on the external write channel. External data writes are through the SCU.

The STB can merge:

- Several store transactions into a single transaction if they are to the same 128-bit aligned address.
- Multiple writes into an AXI or CHI write burst.

The STB is also used to queue maintenance operations before they are broadcast to other cores in the cluster.

See [Chapter 6 Level 1 Memory System](#) for more information.

Bus Interface Unit and SCU interface

The *Bus Interface Unit* (BIU) contains the SCU interface and buffers to decouple the interface from the cache and STB. The BIU interface and the SCU always operate at the processor frequency.

See [Chapter 6 Level 1 Memory System](#) for more information.

2.1.7 L2 memory system

The Cortex-A53 L2 memory system contains the L2 cache pipeline and all logic required to maintain memory coherence between the cores of the cluster. It has the following features:

- An SCU that connects the cores to the external memory system through the master memory interface. The SCU maintains data cache coherency between the cores and arbitrates L2 requests from the cores.

When the Cortex-A53 processor is implemented with a single core, it still includes the *Snoop Control Unit* (SCU). See [Implementation options on page 1-7](#) for more information.

Note

The SCU does not support hardware management of coherency of the instruction caches. Instruction cache linefills perform coherent reads, however, there is no coherency management of data held in the instruction cache.

- An optional L2 cache that:
 - Has a cache RAM size of 128KB, 256KB, 512KB, 1MB, or 2MB.
 - Is 16-way set associative.
 - Supports 64 byte cache lines.
- A 512-bit wide fetch path from the L2 cache.
- A single 128-bit wide master interface to external memory that:
 - Can be implemented using the AMBA 4 ACE or AMBA 5 CHI architectures.
 - Supports integer ratios of the processor clock period up to and including 1:1.
 - Supports a 40-bit physical address range.
- An optional 128-bit wide I/O coherent ACP interface that can allocate to the L2 cache.

See [Chapter 7 Level 2 Memory System](#) for more information.

2.1.8 Cache protection

The Cortex-A53 processor supports cache protection in the form of ECC or parity on all RAM instances in the processor using two separate implementation options:

- SCU-L2 cache protection.
- CPU cache protection.

These options enable the Cortex-A53 processor to detect and correct a one-bit error in any RAM and detect two-bit errors in some RAMs.

2.1.9 Debug and trace

The Cortex-A53 processor supports a range of debug and trace features including:

- ARM v8 debug features in each core.
- ETMv4 instruction trace unit for each core.
- CoreSight *Cross Trigger Interface* (CTI).
- CoreSight *Cross Trigger Matrix* (CTM).
- Debug ROM.

The Cortex-A53 processor has an *Advanced Peripheral Bus version 3* (APBv3) debug interface that is CoreSight compliant. This permits system access to debug resources, for example, the setting of watchpoints and breakpoints.

The Cortex-A53 processor provides performance monitors that can be configured to gather statistics on the operation of each core and the memory system. The performance monitors implement the ARM PMUv3 architecture.

See [Chapter 11 Debug](#), [Chapter 12 Performance Monitor Unit](#), and [Chapter 13 Embedded Trace Macrocell](#) for more information.

2.2 Interfaces

The Cortex-A53 processor has the following external interfaces:

- [Master memory interface](#).
- [Accelerator Coherency Port](#).
- [External debug interface](#).
- [Trace interface](#).
- [CTI on page 2-8](#).
- [DFT on page 2-8](#).
- [MBIST on page 2-8](#).
- [Q-channel on page 2-8](#).

2.2.1 Master memory interface

The processor implements the AMBA 4 ACE or AMBA 5 CHI interface:

- ACE is an extension to the AXI protocol and provides the following enhancements:
 - Support for hardware cache coherency.
 - Barrier transactions that guarantee transaction ordering.
 - Distributed virtual memory messaging, enabling management of a virtual memory system across multiple MPCore clusters.

See the *ARM® AMBA® AXI and ACE Protocol Specification AXI3, AXI4, and AXI4-Lite, ACE and ACE-Lite* for more information.

- CHI is a protocol that provides an architecture for connecting multiple nodes using a scalable interconnect. The nodes on the interconnect might be cores, clusters, I/O bridges, memory controllers, or graphics processors.

See the *ARM® AMBA® 5 CHI Protocol Specification*.

2.2.2 Accelerator Coherency Port

The processor supports an *Accelerator Coherency Port (ACP)*. This is an AMBA 4 AXI slave interface. The ACP is provided to reduce software cache maintenance operations when sharing memory regions with other masters, and to allow other masters to allocate data into the L2 cache.

The ACP slave interface can receive coherent requests from an external master, but it cannot propagate coherent requests from the Cortex-A53 processor.

See [ACP on page 7-19](#) and the *ARM® AMBA® AXI and ACE Protocol Specification AXI3, AXI4, and AXI4-Lite, ACE and ACE-Lite* for more information.

2.2.3 External debug interface

The processor supports an AMBA 3 APB slave interface that enables access to the debug registers. See the *ARM® CoreSight™ Architecture Specification* for more information.

2.2.4 Trace interface

The processor supports dedicated AMBA 4 ATB interfaces for each core that outputs trace information for debugging. The ATB interface is compatible with the CoreSight architecture. See the *ARM® AMBA® 4 ATB Protocol Specification* for more information.

2.2.5 CTI

The Cortex-A53 processor implements a single cross trigger channel interface. This external interface is connected to the CoreSight *Cross Trigger Interface* (CTI) corresponding to each core through a simplified *Cross Trigger Matrix* (CTM). See [Chapter 14 Cross Trigger](#) for more information.

2.2.6 DFT

The processor implements a *Design For Test* (DFT) interface that enables an industry standard *Automatic Test Pattern Generation* (ATPG) tool to test logic outside of the embedded memories. See [DFT interface on page A-32](#) for information on these test signals.

2.2.7 MBIST

The *Memory Built In Self Test* (MBIST) controller interface provides support for manufacturing test of the memories embedded in the Cortex-A53 processor. See [MBIST interface on page A-32](#) for information on this interface.

2.2.8 Q-channel

The Q-channel interfaces enable communication to an external power controller. See [Communication to the Power Management Controller on page 2-26](#).

2.3 Clocking and resets

The following sections describe clocking and resets:

- [Clocks](#).
- [Input synchronization on page 2-13](#).
- [Resets on page 2-14](#).

2.3.1 Clocks

The Cortex-A53 processor has a single clock input, **CLKIN**. All cores in the Cortex-A53 processor and the SCU are clocked with a distributed version of **CLKIN**.

The Cortex-A53 processor has the following clock enable signals:

- [PCLKENDBG](#).
- [ACLKENM on page 2-10](#).
- [ACLKENS on page 2-10](#).
- [SCLKEN on page 2-11](#).
- [ATCLKEN on page 2-12](#).
- [CNTCLKEN on page 2-12](#).

PCLKENDBG

The processor includes an APB interface to access the debug and performance monitoring registers. Internally this interface is driven from **CLKIN**. A separate enable signal, **PCLKENDBG**, is provided to enable the external APB bus to be driven at a lower frequency, that must be an integer ratio of **CLKIN**. If the debug infrastructure in the system is required to be fully asynchronous to the processor clock, you can use a synchronizing component to connect the external AMBA APB to the processor.

[Figure 2-2](#) shows a timing example of **PCLKENDBG** that changes the **CLKIN** to **PCLK** frequency ratio from 3:1 to 1:1.

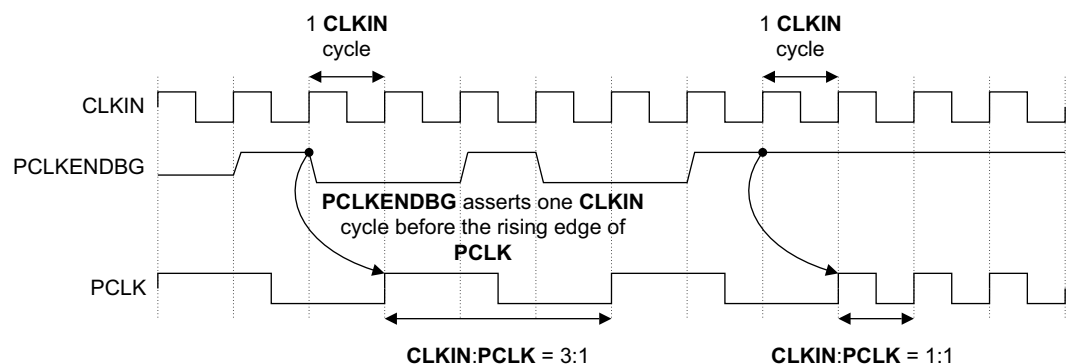

Figure 2-2 PCLKENDBG with CLKIN:PCLK ratio changing from 3:1 to 1:1

Note

[Figure 2-2](#) shows the timing relationship between the debug APB clock, **PCLK** and **PCLKENDBG**, where **PCLKENDBG** asserts one clock cycle before the rising edge of **PCLK**. It is important that the relationship between **PCLK** and **PCLKENDBG** is maintained.

ACLKENM

This signal is present only if the master interface is configured to use the ACE protocol. The master interface supports integer ratios of the **CLKIN** frequency, for example 1:1, 2:1, 3:1. These ratios are configured through external clock enable signals. In all cases AXI transfers remain synchronous. The ACE master interface includes the **ACLKENM** clock enable signal.

ACLKENM asserts one **CLKIN** cycle before the rising edge of the external ACE clock signal, **ACLKM**. If you change the **CLKIN** to **ACLKM** frequency ratio, you must change **ACLKENM** correspondingly.

Figure 2-3 shows a timing example of **ACLKENM** that changes the **CLKIN** to **ACLKM** frequency ratio from 3:1 to 1:1.

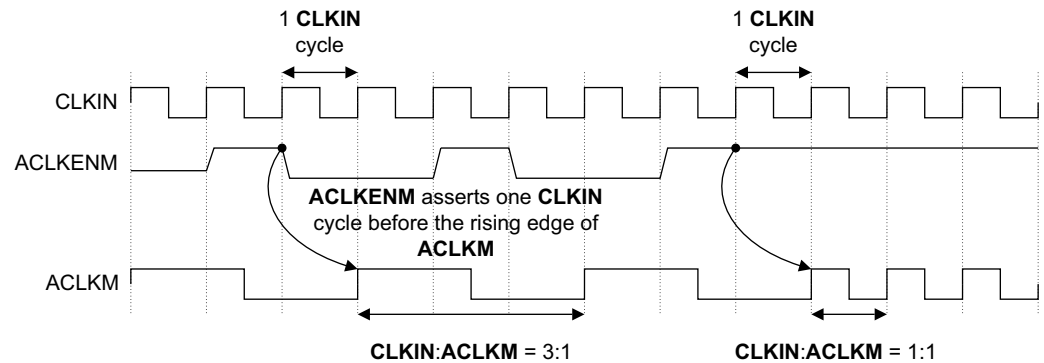

Figure 2-3 **ACLKENM** with **CLKIN:ACLKM** ratio changing from 3:1 to 1:1

Note

- Figure 2-3 shows the timing relationship between the AXI master clock, **ACLKM** and **ACLKENM**, where **ACLKENM** asserts one clock cycle before the rising edge of **ACLKM**. It is important that the relationship between **ACLKM** and **ACLKENM** is maintained.
- If there are any physical effects that could occur while changing the clock frequency, ARM recommends that the clock ratio is changed only while the **STANDBYWFI2** output of the processor is asserted.
- The input signal **ACLKENM** exists in the Cortex-A53 processor if it is configured to include the ACE interface.

ACLKENS

This signal is present only if the processor is configured with the ACP slave interface. The slave interface supports integer ratios of the **CLKIN** frequency, for example 1:1, 2:1, 3:1. These ratios are configured through external clock enable signals. In all cases AXI transfers remain synchronous. The ACP slave interface includes the **ACLKENS** clock enable signal.

ACLKENS asserts one **CLKIN** cycle before the rising edge of the external ACP clock signal, **ACLKS**. If you change the **CLKIN** to **ACLKS** frequency ratio, you must change **ACLKENS** correspondingly.

Figure 2-4 on page 2-11 shows a timing example of **ACLKENS** that changes the **CLKIN** to **ACLKS** frequency ratio from 3:1 to 1:1.

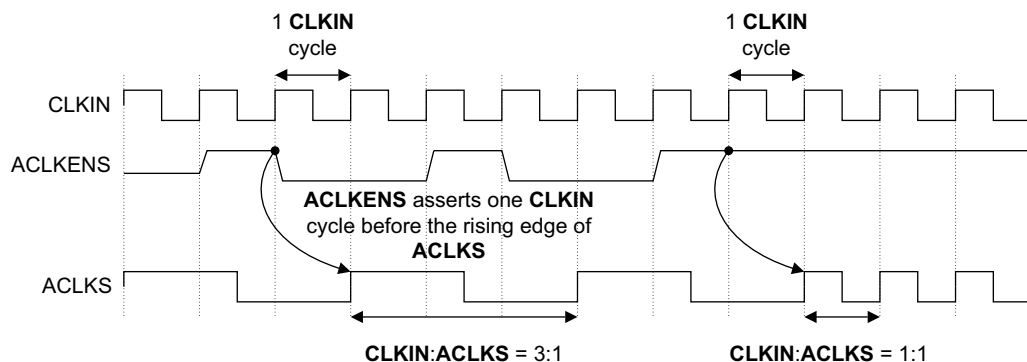

Figure 2-4 ACLKENS with CLKIN:ACLKS ratio changing from 3:1 to 1:1

Note

- Figure 2-4 shows the timing relationship between the AXI slave clock, **ACLKS** and **ACLKENS**, where **ACLKENS** asserts one clock cycle before the rising edge of **ACLKS**. It is important that the relationship between **ACLKS** and **ACLKENS** is maintained.
- If there are any physical effects that could occur while changing the clock frequency, ARM recommends that the clock ratio is changed only while the **STANDBYWFL2** output of the processor is asserted.
- The input signal **ACLKENS** exists in the Cortex-A53 processor if it is configured to include the ACP interface.

SCLKEN

This signal is present only if the master interface is configured to use the CHI protocol. The SCU interface supports integer ratios of the **CLKIN** frequency, for example 1:1, 2:1, 3:1. These ratios are configured through external clock enable signals. In all cases CHI transfers remain synchronous. The CHI master interface includes the **SCLKEN** clock enable signal.

Figure 2-5 shows a timing example of **SCLKEN** that changes the **CLKIN** to **SCLK** frequency ratio from 3:1 to 1:1.

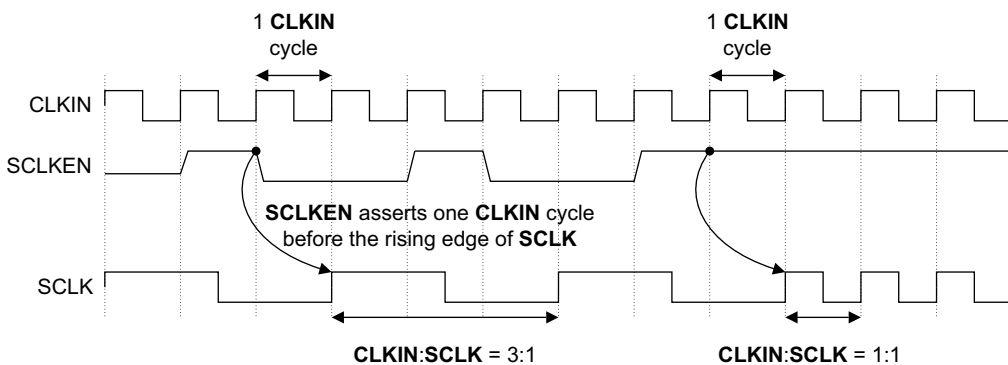

Figure 2-5 SCLKEN with CLKIN:SCLK ratio changing from 3:1 to 1:1

Note

- Figure 2-5 shows the timing relationship between the CHI clock, **SCLK** and **SCLKEN**, where **SCLKEN** asserts one **CLKIN** cycle before the rising edge of **SCLK**. It is important that the relationship between **SCLK** and **SCLKEN** is maintained.

- If there are any physical effects that could occur while changing the clock frequency, ARM recommends that the clock ratio is changed only while the **STANDBYWFIL2** output of the processor is asserted.
- The input signal **SCLKEN** exists in the Cortex-A53 processor if it is configured to include the CHI interface.

ATCLKEN

The ATB interface is a synchronous interface that can operate at any integer multiple that is equal to or slower than the main processor clock, **CLKIN**, using the **ATCLKEN** signal. For example, the **CLKIN** to **ATCLK** frequency ratio can be 1:1, 2:1, or 3:1, where **ATCLK** is the ATB bus clock. **ATCLKEN** asserts one **CLKIN** cycle before the rising edge of **ATCLK**. If you change the **CLKIN** to **ATCLK** frequency ratio, you must change **ATCLKEN** correspondingly.

Figure 2-6 shows a timing example of **ATCLKEN** that changes the **CLKIN** to **ATCLK** frequency ratio from 3:1 to 1:1.

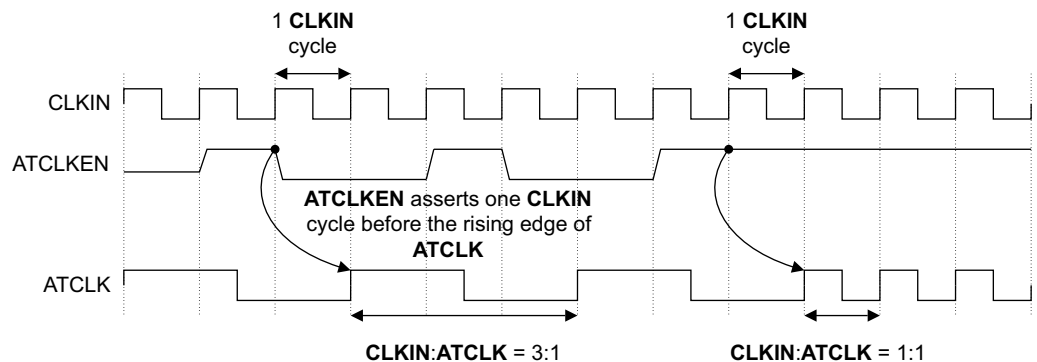

Figure 2-6 ATCLKEN with **CLKIN:ATCLK** ratio changing from 3:1 to 1:1

Note

Figure 2-6 shows the timing relationship between the ATB clock, **ATCLK** and **ATCLKENDBG**, where **ATCLKENDBG** asserts one clock cycle before the rising edge of **ATCLK**. It is important that the relationship between **ATCLK** and **ATCLKENDBG** is maintained.

CNTCLKEN

The **CNTVALUEB** is a synchronous 64-bit binary encoded counter value that can operate at any integer multiple that is equal to or slower than the main processor clock, **CLKIN**, using the **CNTCLKEN** signal. For example, you can set the **CLKIN** to **CNTCLK** frequency ratio to 1:1, 2:1, or 3:1, where **CNTCLK** is the system counter clock. **CNTCLKEN** asserts one **CLKIN** cycle prior to the rising edge of **CNTCLK**.

Figure 2-7 on page 2-13 shows a timing example of **CNTCLKEN** that changes the **CLKIN** to **CNTCLK** frequency ratio from 3:1 to 1:1.

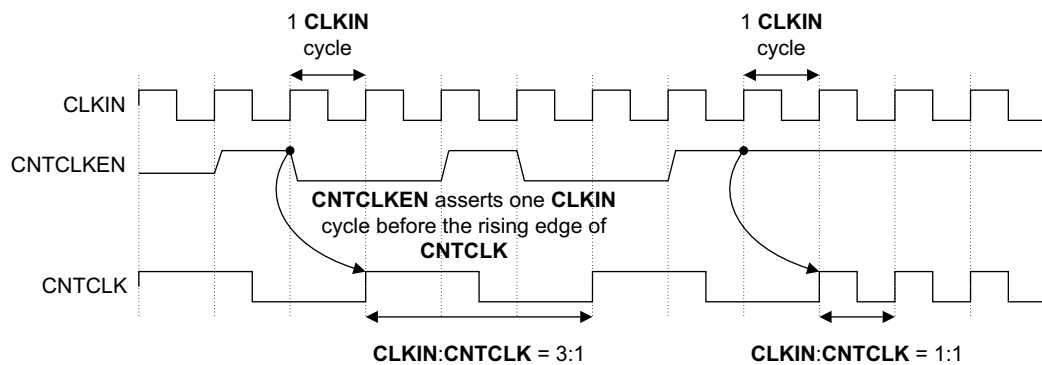

Figure 2-7 CNTCLKEN with CLKIN: CNTCLK ratio changing from 3:1 to 1:1

———— Note ————

Figure 2-7 shows the timing relationship between the system counter clock, CLKIN and CNTCLKEN, where CNTCLKEN asserts one clock cycle before the rising edge of CLKIN. It is important that the relationship between CLKIN and CNTCLKEN is maintained.

2.3.2 Input synchronization

The Cortex-A53 processor synchronizes the input signals:

- nCORERESET.
- nCPUPORESET.
- nFIQ.
- nIRQ.
- nL2RESET.
- nMBISTRESET.
- nPRESETDBG.
- nREI.
- nSEI.
- nVFIQ.
- nVIRQ.
- nVSEI.
- CLREXMONREQ.
- CPUQREQn.
- CTICHIN.
- CTICHOUTACK.
- CTIIRQACK.
- DBGEN.
- EDBGREQ.
- EVENTI.
- L2FLUSHREQ.
- L2QREQn.
- NEONQREQn.
- NIDEN.
- SPIDEN.
- SPNIDEN.

The SoC can present these inputs asynchronously. All other external signals must be synchronous with reference to **CLKIN**.

———— **Note** —————

The synchronised **CTICHIN** input signals are used only if the **CISBYPASS** input signal is deasserted LOW. If the **CISBYPASS** signal is asserted HIGH the **CTICHIN** synchronizers are not used, and the SoC must present the **CTICHIN** synchronously to **CLKIN**.

2.3.3 Resets

The Cortex-A53 processor has the following active-LOW reset input signals:

nCPUPORESET[CN:0]

Where **CN** is the number of cores minus one.

These primary, cold reset signals initialize all resettable registers in the corresponding core, including debug registers and ETM registers.

nCORERESET[CN:0]

These primary reset signals initialize all resettable registers in the corresponding core, not including debug registers and ETM registers.

nPRESETDBG

This single, cluster-wide signal resets the integrated CoreSight components that connect to the external **PCLK** domain, such as debug logic.

nL2RESET

This single, cluster-wide signal resets all resettable registers in the L2 memory system and the logic in the SCU.

nMBISTRESET

An external MBIST controller can use this signal to reset the entire SoC. The **nMBISTRESET** signal resets all resettable registers in the cluster, for entry into, and exit from, MBIST mode.

All of these resets can be asynchronously:

- Asserted, HIGH to LOW.
- Deasserted, LOW to HIGH.

Reset synchronisation logic inside the Cortex-A53 processor ensures that reset deassertion is synchronous for all resettable registers. The processor clock is not required for reset assertion, but the processor clock must be present for reset deassertion to ensure reset synchronisation.

In general, you only have to hold reset signals active for three processor clock cycles for the reset to take effect. However, you must hold the reset signal LOW until the power returns and the unit or processor is ready for the reset to take effect if:

- The Advanced SIMD and Floating-point unit of a core undergoing a reset is in retention state.
- A core that is being reset is in retention state.

This is the responsibility of the system implementer, because the time taken for retention exit and the behavior of the power controller varies by partner and by implementation.

[Table 2-1 on page 2-15](#) describes the valid reset signal combinations. All other combinations of reset signals are illegal. In the table, *n* designates the core that is reset.

Table 2-1 Valid reset combinations

Reset combination	Signals	Value	Description
Cluster cold reset	nCPUPORESET[CN:0] nCORERESET[CN:0] nPRESETDBG nL2RESET nMBISTRESET	all = 0 ^a all = X ^a 0 0 1	All logic is held in reset.
Cluster cold reset with debug active	nCPUPORESET[CN:0] nCORERESET[CN:0] nPRESETDBG nL2RESET nMBISTRESET	all = 0 ^a all = X ^a 1 0 1	All cores are held in reset so they can be powered up. The L2 is held in reset, but must remain powered up. This enables external debug over power down for the cluster.
Individual core cold reset with debug active	nCPUPORESET[CN:0] nCORERESET[CN:0] nPRESETDBG nL2RESET nMBISTRESET	[n] = 0 ^a [n] = X ^a 1 1 1	Individual core is held in reset, so that the core can be powered up. This enables external debug over power down for the core that is held in reset.
Individual core warm reset with trace and debug active	nCPUPORESET[CN:0] nCORERESET[CN:0] nPRESETDBG nL2RESET nMBISTRESET	[n] = 1 [n] = 0 1 1 1	Individual core is held in reset.
Debug logic reset	nCPUPORESET[CN:0] nCORERESET[CN:0] nPRESETDBG nL2RESET nMBISTRESET	all = 1 all = 1 0 1 1	Cluster debug logic is held in reset.
MBIST reset	nCPUPORESET[CN:0] nCORERESET[CN:0] nPRESETDBG nL2RESET nMBISTRESET	all = 1 all = 1 1 1 0	All logic is held in reset.
Normal state	nCPUPORESET[CN:0] nCORERESET[CN:0] nPRESETDBG nL2RESET nMBISTRESET	all = 1 all = 1 1 1 1	No logic is held in reset.

a. For cold reset, **nCPUPORESET** must be asserted. **nCORERESET** can be asserted, but is not required.

2.4 Power management

The Cortex-A53 processor provides mechanisms and support to control both dynamic and static power dissipation. The individual cores in the Cortex-A53 processor support four main levels of power management. This section describes:

- [Power domains](#).
- [Power modes on page 2-17](#).
- [Event communication using WFE or SEV on page 2-25](#).
- [Communication to the Power Management Controller on page 2-26](#).

2.4.1 Power domains

[Table 2-2](#) shows the power domains that the Cortex-A53 processor supports:

Table 2-2 Power domain description

Power domain	Description
PDCORTEXA53	This includes the SCU, the optional L2 cache controller, and debug registers described as being in the debug domain.
PDL2	This includes the L2 data RAM, L2 tag RAM, L2 victim RAM, and the SCU duplicate tag RAM.
PDCPU<n ^a >	This includes the optional Advanced SIMD and Floating-point Extension, the L1 TLB, L1 processor RAMs, and debug registers described as being in the processor domain.
PDCPUADVSIMD<n ^a >	This represents the Advanced SIMD and Floating-point block of core n.

- a. <n> where n is 0, 1, 2, or 3. This represents core 0, core 1, core 2, or core 3. If a core is not present, the corresponding Power Domain is not present.

The separate PDCORTEXA53 and PDL2 power domains can remain active even when all the cores are powered down. This means the Cortex-A53 processor can continue to accept snoops from external devices to access the L2 cache.

[Figure 2-8 on page 2-17](#) shows an example of the domains embedded in a *System-on-Chip* (SoC) power domain.

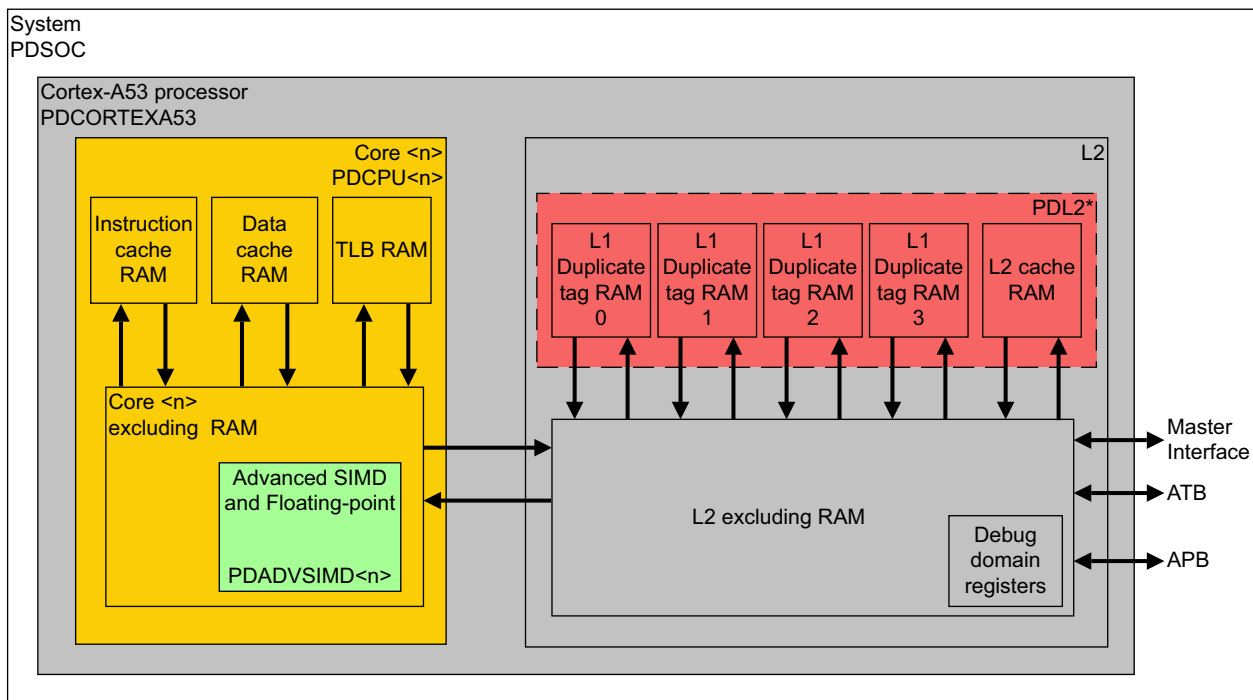

*If implementation includes Dormant mode support

Figure 2-8 Power domains

2.4.2 Power modes

The power domains can be controlled independently to give different combinations of powered-up and powered-down domains. However, only some powered-up and powered-down domain combinations are valid and supported.

Table 2-4 on page 2-18 and Table 2-5 on page 2-18 show the supported power domain states for the Cortex-A53 processor. The terms used are defined in Table 2-3.

Table 2-3 Power state description

Power state	Description
Off	Block is power gated
Ret	Logic or RAM retention power only
On	Block is active

Caution

States not shown in Table 2-4 on page 2-18 and Table 2-5 on page 2-18 are unsupported and must not occur.

Table 2-4 Supported processor power states

Power domains			Description
PDCORTEXA53	PDL2	PDCPU<n>	
Off	Off	Off	Cluster off - L2 RAMs and all cores are off.
Off	On/Ret	Off	L2 Dormant mode - L2 RAMs retained and all cores are off.
On	Ret	Off/Ret ^a	L2 Retention - L2 RAMs retained and all cores either retained or turned off.
On	On	See Table 2-5	Cluster L2 RAM active - L2 RAM active and all cores are in either on, off or retention state.

a. All cores in the cluster to be in WFE, WFI, retention or powered off.

[Table 2-5](#) describes the supported power domain states for individual cores. The power domain state in each core is independent of all other cores.

Table 2-5 Supported core power states

Power domains		Description
PDCPU	PDADVSIMD	
Off	Off	Core off.
On	On	Core on - Advanced SIMD and Floating-point on.
On	Ret	AdvSIMD retention - Advanced SIMD and Floating-point in retention.
Ret	Ret	Core retention - core logic and Advanced SIMD and Floating-point in retention.

You must follow the dynamic power management and powerup and powerdown sequences described in the following sections. Any deviation from these sequences can lead to UNPREDICTABLE results.

The supported power modes are:

- [Normal state](#).
- [Standby state on page 2-19](#).
- [Individual core shutdown mode on page 2-21](#).
- [Cluster shutdown mode without system driven L2 flush on page 2-22](#).
- [Cluster shutdown mode with system driven L2 flush on page 2-23](#).
- [Dormant mode on page 2-24](#).
- [Retention state on page 2-25](#).

Normal state

This is the normal mode of operation where all of the processor functionality is available. The Cortex-A53 processor uses gated clocks and gates to disable inputs to unused functional blocks. Only the logic in use to perform an operation consumes any dynamic power.

Standby state

The following sections describe the methods of entering standby state:

- [Core Wait for Interrupt](#).
- [Core Wait for Event on page 2-20](#).
- [L2 Wait for Interrupt on page 2-20](#).

Core Wait for Interrupt

Wait for Interrupt is a feature of the ARMv8-A architecture that puts the core in a low-power state by disabling most of the clocks in the core while keeping the core powered up. Apart from a small dynamic power overhead on the logic to enable the core to wake up from WFI low-power state, this reduces the power drawn to static leakage current only.

Software indicates that the core can enter the WFI low-power state by executing the WFI instruction.

When the core is executing the WFI instruction, the core waits for all instructions in the core to retire before entering the idle or low power state. The WFI instruction ensures that all explicit memory accesses, that occurred before the WFI instruction in program order, have retired. For example, the WFI instruction ensures that the following instructions received the required data or responses from the L2 memory system:

- Load instructions.
- Cache and TLB maintenance operations.
- Store exclusive instructions.

In addition, the WFI instruction ensures that store instructions have updated the cache or have been issued to the SCU.

While the core is in WFI low-power state, the clocks in the core are temporarily enabled without causing the core to exit WFI low-power state, when any of the following events are detected:

- A snoop request that must be serviced by the core L1 Data cache.
- A cache or TLB maintenance operation that must be serviced by the core L1 Instruction cache, data cache, or TLB.
- An APB access to the debug or trace registers residing in the core power domain.

Exit from WFI low-power state occurs when the core detects a reset or one of the WFI wake up events as described in the *ARM® Architecture Reference Manual ARMv8, for ARMv8-A architecture profile*.

On entry into WFI low-power state, **STANDBYWFI** for that core is asserted. Assertion of **STANDBYWFI** guarantees that the core is in idle and low power state. **STANDBYWFI** continues to assert even if the clocks in the core are temporarily enabled because of an L2 snoop request, cache, or TLB maintenance operation or an APB access.

———— Note ————

STANDBYWFI does not indicate completion of L2 memory system transactions initiated by the processor. All Cortex-A53 processor implementations contain an L2 memory system. This includes implementations without an L2 cache.

Core Wait for Event

Wait for Event (WFE) is a feature of the ARMv8-A architecture that can be used by a locking mechanism based on events to put the core in a low power state by disabling most of the clocks in the core while keeping the core powered up. Apart from a small dynamic power overhead on the logic to enable the core to wake up from WFE low-power state, this reduces the power drawn to static leakage current only.

A core enters into WFE low-power state by executing the WFE instruction. When executing the WFE instruction, the core waits for all instructions in the core to complete before entering the idle or low power state.

If the event register is set, execution of WFE does not cause entry into standby state, but clears the event register.

While the core is in WFE low-power state, the clocks in the core are temporarily enabled without causing the core to exit WFE low-power state, when any of the following events are detected:

- An L2 snoop request that must be serviced by the core L1 Data cache.
- A cache or TLB maintenance operation that must be serviced by the core L1 Instruction cache, data cache, or TLB.
- An APB access to the debug or trace registers residing in the core power domain.

Exit from WFE low-power state occurs when the core detects a reset, the assertion of the **EVENTI** input signal, or one of the WFE wake up events as described in the *ARM® Architecture Reference Manual ARMv8, for ARMv8-A architecture profile*.

On entry into WFE low-power state, **STANDBYWFE** for that core is asserted. Assertion of **STANDBYWFE** guarantees that the core is in idle and low power state. **STANDBYWFE** continues to assert even if the clocks in the core are temporarily enabled because of an L2 snoop request, cache, and TLB maintenance operation or an APB access.

CLREXMON request and acknowledge signaling

When the **CLREXMONREQ** input is asserted, it signals the clearing of an external global exclusive monitor and acts as WFE wake-up event to all the cores in the cluster.

The **CLREXMONREQ** signal has a corresponding **CLREXMONACK** response signal. This forms a standard 2-wire, 4-phase handshake that can be used to signal across the voltage and frequency boundary between the core and system.

Figure 2-9 shows the **CLREXMON** request and acknowledge handshake. When the request signal is asserted, it continues to assert until an acknowledge is received. When the request is deasserted, the acknowledge can then deassert.



Figure 2-9 CLREXMON request and acknowledge handshake

L2 Wait for Interrupt

When all the cores are in WFI low-power state, the shared L2 memory system logic that is common to all the cores can also enter a WFI low-power state.

Entry into L2 WFI low-power state can occur only if specific requirements are met and the following sequence applied:

- All cores are in WFI low-power state and therefore, the **STANDBYWFI** output for each core is asserted. Assertion of all the cores **STANDBYWFI** outputs guarantee that all the cores are in idle and low power state. All clocks in the cores, with the exception of a small amount of clock wake up logic, are disabled.
- If configured with ACE, the SoC asserts the input pin **ACINACTM** to idle the AXI master interface. This indicates that no snoop requests will be made from the external memory system.
- If configured with a CHI interface, the SoC asserts the input pin **SINACT** to idle the CHI master interface. This indicates that no snoop requests will be made from the external memory system.
- If configured with an ACP interface, the SoC asserts the **AINACTS** input pin to idle the ACP interface. This indicates that the SoC sends no more transaction on the ACP interface.

When the L2 memory system completes the outstanding transactions for AXI or CHI interfaces, it can then enter the low power state, L2 WFI low-power state. On entry into L2 WFI low-power state, **STANDBYWFIL2** is asserted. Assertion of **STANDBYWFIL2** guarantees that the L2 memory system is idle and does not accept new transactions.

Exit from L2 WFI low-power state occurs on one of the following events:

- A physical IRQ or FIQ interrupt.
- A debug event.
- Powerup or warm reset.

When a core exits from WFI low-power state, **STANDBYWFI** for that core is deasserted. When the L2 memory system logic exits from WFI low-power state, **STANDBYWFIL2** is deasserted. The SoC must continue to assert **ACINACTM** or **SINACT** until **STANDBYWFIL2** has deasserted.

Figure 2-10 shows the L2 WFI timing for a 4-core configuration.

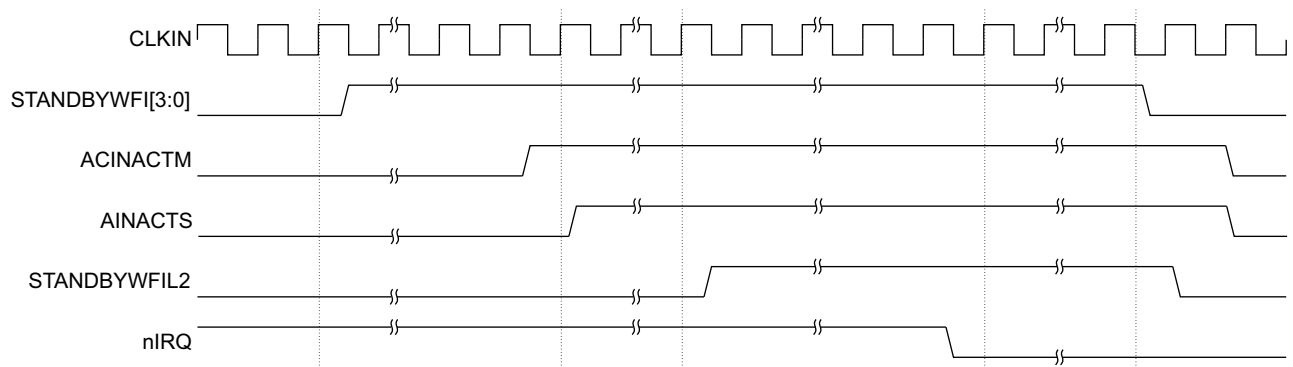

Figure 2-10 L2 Wait For Interrupt timing

Individual core shutdown mode

In this mode, the PDCPU power domain for an individual core is shut down and all state is lost.

For full shutdown of the Cortex-A53 processor, including implementations with a single core, see [Cluster shutdown mode without system driven L2 flush on page 2-22](#) and [Cluster shutdown mode with system driven L2 flush on page 2-23](#).

To enable a core to be powered down, the implementation must place the core on a separately controlled power supply. In addition, you must clamp the outputs of the core to benign values while the entire cluster is powered down, to indicate that the core is idle.

To power down the core, apply the following sequence:

1. Disable the data cache, by clearing the SCTLR.C bit, or the HSCTLR.C bit if in Hyp mode. This prevents more data cache allocations and causes cacheable memory attributes to change to Normal Non-cacheable. Subsequent loads and stores do not access the L1 or L2 caches.
2. Clean and invalidate all data from the L1 Data cache. The L2 duplicate snoop tag RAM for this core is now empty. This prevents any new data cache snoops or data cache maintenance operations from other cores in the cluster being issued to this core.
3. Disable data coherency with other cores in the cluster, by clearing the CPUECTLR.SMPEN bit. Clearing the SMPEN bit enables the core to be taken out of coherency by preventing the core from receiving cache or TLB maintenance operations broadcast by other cores in the cluster.
4. Execute an ISB instruction to ensure that all of the register changes from the previous steps have been committed.
5. Execute a DSB SY instruction to ensure that all cache, TLB and branch predictor maintenance operations issued by any core in the cluster device before the SMPEN bit was cleared have completed.
6. Execute a WFI instruction and wait until the **STANDBYWFI** output is asserted to indicate that the core is in idle and low power state.
7. Deassert **DBGPWRDUP** LOW. This prevents any external debug access to the core.
8. Activate the core output clamps.
9. Remove power from the PDCPU power domain.

To power up the core, apply the following sequence:

1. Assert **nCPUPORESET** LOW. Ensure **DBGPWRDUP** is held LOW to prevent any external debug access to the core.
2. Apply power to the PDCPU power domain. Keep the state of the signals **nCPUPORESET** and **DBGPWRDUP** LOW.
3. Release the core output clamps.
4. Deassert resets.
5. Set the SMPEN bit to 1 to enable snooping into the core.
6. Assert **DBGPWRDUP** HIGH to allow external debug access to the core.
7. If required use software to restore the state of the core as it was prior to powerdown.

Cluster shutdown mode without system driven L2 flush

This is the mode where the PDCORTEXA53, PDL2, and PDCPU power domains are shut down and all state is lost. In this section, a lead core is defined as the last core to switch off, or the first core to switch on. To power down the cluster, apply the following sequence:

1. Ensure all non-lead cores are in shutdown mode, see [Individual core shutdown mode on page 2-21](#).

2. Follow steps 1 to 2 in [Individual core shutdown mode on page 2-21](#).
3. If the ACP interface is configured, ensure that any master connected to the interface does not send new transactions, then assert **AINACTS**.
4. Clean and invalidate all data from the L2 Data cache.
5. Follow steps 3 to 9 in [Individual core shutdown mode on page 2-21](#).
6. In an ACE configuration, assert **ACINACTM** or, in a CHI configuration, assert **SINACT**. Then wait until the **STANDBYWFIL2** output is asserted to indicate that the L2 memory system is idle. All Cortex-A53 processor implementations contain an L2 memory system, including implementations without an L2 cache.
7. Activate the cluster output clamps.
8. Remove power from the PDCORTEXA53 and PDL2 power domains.

Note

For device powerdown, all operations on the lead core must occur after the equivalent step on all non-lead cores.

To power up the cluster, apply the following sequence:

1. For each core in the cluster, assert **nCPUPORESET** LOW.
2. Assert **nL2RESET** LOW and hold **L2RSTDISABLE** LOW.
3. Apply power to the PDCORTEXA53 and PDL2 domains while keeping the signals described in steps 1. and 2. LOW.
4. Release the cluster output clamps.
5. Continue a normal cold reset sequence.

Cluster shutdown mode with system driven L2 flush

This is the mode where the PDCORTEXA53, PDL2, and PDCPU power domains are shut down and all state is lost. To power down the cluster, apply the following sequence:

1. Ensure all cores are in shutdown mode, see [Individual core shutdown mode on page 2-21](#).
2. The SoC asserts the **AINACTS** signal to idle the ACP. This is necessary to prevent ACP transactions from allocating new entries in the L2 cache while the hardware cache flush is occurring.
3. Assert **L2FLUSHREQ** HIGH.
4. Hold **L2FLUSHREQ** HIGH until **L2FLUSHDONE** is asserted.
5. Deassert **L2FLUSHREQ**.
6. In an ACE configuration, assert **ACINACTM** or, in a CHI configuration, assert **SINACT**. Then wait until the **STANDBYWFIL2** output is asserted to indicate that the L2 memory system is idle. All Cortex-A53 processor implementations contain an L2 memory system, including implementations without an L2 cache.
7. Activate the cluster output clamps.
8. Remove power from the PDCORTEXA53 and PDL2 power domains.

Note

For device powerdown, all operations on a lead core must occur after the equivalent step on all non-lead cores.

To power up the cluster, apply the following sequence:

1. For each core in the cluster, assert **nCPUPORESET** LOW.
2. Assert **nL2RESET** LOW and hold **L2RSTDISABLE** LOW.
3. Apply power to the PDCORTEXA53 and PDL2 domains while keeping the signals described in steps 1 and 2 LOW.
4. Release the cluster output clamps.
5. Continue a normal cold reset sequence.

Dormant mode

Optionally, the Dormant mode is supported in the cluster. In this mode all the cores and L2 control logic are powered down while the L2 cache RAMs are powered up and retain state. The RAM blocks that remain powered up during Dormant mode are:

- L2 tag RAMs.
- L2 data RAMs.
- L2 victim RAM.

To support Dormant mode, you must ensure:

- That the L2 cache RAMs are in a separate power domain.
- To clamp all inputs to the L2 cache RAMs to benign values. This avoids corrupting data when the cores and L2 control power domains enter and exit power down state.

Before entering Dormant mode the architectural state of the cluster, excluding the contents of the L2 cache RAMs that remain powered up, must be saved to external memory.

To exit from Dormant mode to Normal state, the SoC must perform a cold reset sequence. The SoC must assert the reset signals until power is restored. After power is restored, the cluster exits the cold reset sequence, and the architectural state must be restored.

To enter Dormant mode, apply the following sequence:

1. Disable the data cache, by clearing the SCTL.R.C bit, or the HSCTL.R.C bit if in Hyp mode. This prevents more data cache allocations and causes cacheable memory attributes to change to Normal Non-cacheable. Subsequent loads and stores do not access the L1 or L2 caches.
2. Clean and invalidate all data from the L1 Data cache. The L2 duplicate snoop tag RAM for this core is now empty. This prevents any new data cache snoops or data cache maintenance operations from other cores in the cluster being issued to this core.
3. Disable data coherency with other cores in the cluster, by clearing the CPUECTLR.SMPEN bit. Clearing the SMPEN bit enables the core to be taken out of coherency by preventing the core from receiving cache or TLB maintenance operations broadcast by other cores in the cluster.
4. Save architectural state, if required. These state saving operations must ensure that the following occur:
 - All ARM registers, including the CPSR and SPSR, are saved.

- All system registers are saved.
 - All debug related state is saved.
5. Execute an ISB instruction to ensure that all of the register changes from the previous steps have been committed.
 6. Execute a DSB instruction to ensure that all cache, TLB and branch predictor maintenance operations issued by any core in the cluster before the SMPEN bit was cleared have completed. In addition, this ensures that all state saving has completed.
 7. Execute a WFI instruction and wait until the **STANDBYWFI** output is asserted, to indicate that the core is in idle and low power state.
 8. Repeat the previous steps for all cores, and wait for all **STANDBYWFI** outputs to be asserted.
 9. If the ACP interface is configured, ensure that any master connected to the interface does not send new transactions, then assert **AINACTS**.
 10. If ACE is implemented, the SoC asserts the input pin **ACINACTM** to idle the AXI master interface after all snoop transactions have been sent on the interface. If CHI is implemented, the SoC asserts the input pin **SINACT**.
When the L2 has completed the outstanding transactions for the AXI master and slave interfaces, **STANDBYWFI2** is asserted to indicate that L2 memory system is idle. All Cortex-A53 processor implementations contain an L2 memory system, including implementations without an L2 cache.
 11. When all cores **STANDBYWFI** and **STANDBYWFI2** are asserted, the cluster is ready to enter Dormant mode.
 12. Activate the L2 cache RAM input clamps.
 13. Remove power from the PDCPU and PDCORTEXA53 power domains.

To exit Dormant mode, apply the following sequence:

1. Apply a normal cold reset sequence. You must apply resets to the cores and the L2 memory system logic until power is restored. During this reset sequence, **L2RSTDISABLE** must be held HIGH to disable the L2 cache hardware reset mechanism.
2. When power has been restored, release the L2 cache RAM input clamps.
3. Continue a normal cold reset sequence with **L2RSTDISABLE** held HIGH.
4. The architectural state must be restored, if required.

Retention state

Contact ARM for information about retention state.

2.4.3 Event communication using WFE or SEV

An external agent can use the **EVENTI** pin to participate in a WFE or SEV event communication with the Cortex-A53 processor. When this pin is asserted, it sends an event message to all the cores in the device. This is similar to executing a SEV instruction on one core in the cluster. This enables the external agent to signal to the cores that it has released a semaphore and that the cores can leave the WFE low-power state. The **EVENTI** input pin must remain HIGH for at least one **CLKIN** clock cycle to be visible by the cores.

The external agent can determine that at least one of the cores in the cluster has executed an SEV instruction by checking the **EVENTO** pin. When SEV is executed by any of the cores in the cluster, an event is signaled to all the cores in the device, and the **EVENTO** pin is asserted. This pin is asserted HIGH for three **CLKIN** clock cycles when any core in the cluster executes an SEV instruction.

2.4.4 Communication to the Power Management Controller

Communication between the Cortex-A53 processor and the system power management controller can be performed using one or both of the:

- [STANDBYWFI\[3:0\] and STANDBYWFIL2 signals](#).
- [Q-channel on page 2-27](#).

STANDBYWFI[3:0] and STANDBYWFIL2 signals

The **STANDBYWFI[n]** signal indicates when an individual core is in idle and low power state. The power management controller can remove power from an individual core when **STANDBYWFI[n]** is asserted. See [Individual core shutdown mode on page 2-21](#) for more information.

The **STANDBYWFIL2** signal indicates when all individual cores and the L2 memory system are in idle and low power state. A power management controller can remove power from the Cortex-A53 processor when **STANDBYWFIL2** is asserted. See [Cluster shutdown mode without system driven L2 flush on page 2-22](#) and [Cluster shutdown mode with system driven L2 flush on page 2-23](#) for more information.

Note

The Cortex-A53 processor includes a minimal L2 memory system in configurations without an L2 cache. Therefore, the power management controller must always wait for assertion of **STANDBYWFIL2** before removing power from the Cortex-A53 processor.

[Figure 2-11 on page 2-27](#) shows how **STANDBYWFI[3:0]** and **STANDBYWFIL2** correspond to individual cores and the Cortex-A53 processor.

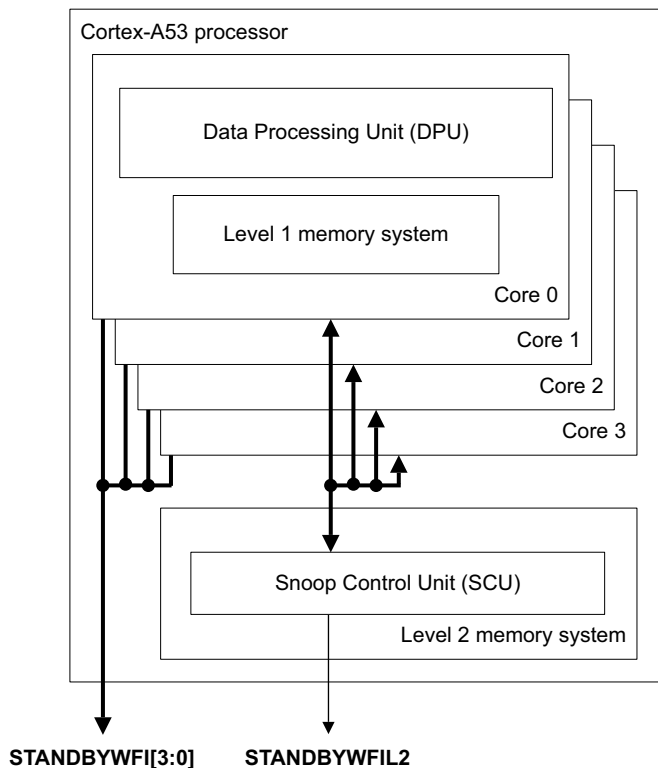

Figure 2-11 STANDBYWFI[3:0] and STANDBYWFI2 signals

Q-channel

Q-channel is a clock and power controller to device interface, to manage device quiescence. The interface enables:

- The controller to manage entry to, and exit from, a device quiescent state. Quiescence management is typically of, but not restricted to, clock gated, and power gated retention states, of the device or device partitions.
- The capability to indicate a requirement for exit from the quiescent state. The associated signalling can contain contributions from other devices dependent on the interfaced device's operations.
- Optional device capability to deny a quiescence request.
- Safe asynchronous interfacing across clock domains.

Chapter 3

Programmers Model

This chapter describes the processor registers and provides information for programming the Cortex-A53 processor. It contains the following sections:

- *About the programmers model on page 3-2.*
- *ARMv8-A architecture concepts on page 3-4.*

3.1 About the programmers model

The Cortex-A53 processor implements the ARMv8-A architecture. This includes:

- Support for all the Exception levels, EL3-EL0.
- Support for both Execution states, AArch64 and AArch32, at each Exception level.
- The following instruction sets:
 - AArch64 Execution state**
The A64 instruction set.
 - AArch32 Execution state**
The T32 and A32 instruction sets.
- Optionally, an implementation can include one or more of:
 - The Advanced SIMD and Floating-point instructions, in all instruction sets.
 - The Cryptography Extension, that provides additional instructions in all instruction sets.

See the *ARM® Architecture Reference Manual ARMv8, for ARMv8-A architecture profile* for more information.

This section describes:

- [Advanced SIMD and Floating-point support](#).
- [Memory model on page 3-3](#).
- [Jazelle implementation on page 3-3](#).
- [Modes of operation on page 3-3](#).

3.1.1 Advanced SIMD and Floating-point support

Advanced SIMD is a media and signal processing architecture that adds instructions targeted primarily at audio, video, 3-D graphics, image, and speech processing.

Floating-point performs single-precision and double-precision floating-point operations.

———— **Note** —————

Advanced SIMD, its associated implementations, and supporting software, are commonly referred to as NEON.

All scalar floating-point instructions are available in the A64 instruction set. All VFP instructions are available in the A32 and T32 instruction sets.

The same Advanced SIMD instructions are available in both the A32 and T32 instruction sets. The A64 instruction set offers additional Advanced SIMD instructions, including double-precision floating-point vector operations.

See the *ARM® Architecture Reference Manual ARMv8, for ARMv8-A architecture profile* for more information.

See the *ARM® Cortex®-A53 MPCore Processor Advanced SIMD and Floating-point Extension Technical Reference Manual* for implementation-specific information.

3.1.2 Memory model

The Cortex-A53 processor views memory as a linear collection of bytes numbered in ascending order from zero. For example, bytes 0-3 hold the first stored word, and bytes 4-7 hold the second stored word.

The processor can store words in memory as either:

- Big-endian format.
- Little-endian format.

See the *ARM® Architecture Reference Manual ARMv8, for ARMv8-A architecture profile* for more information about big-endian and little-endian memory systems.

Note

Instructions are always little-endian.

3.1.3 Jazelle implementation

The Cortex-A53 processor supports a trivial Jazelle implementation. This means:

- Jazelle state is not supported.
- The BXJ instruction behaves as a BX instruction.

In the trivial Jazelle implementation, the processor does not accelerate the execution of any bytecodes, and the JVM uses software routines to execute all bytecodes. See the *ARM® Architecture Reference Manual ARMv8, for ARMv8-A architecture profile* for information.

3.1.4 Modes of operation

In AArch32, the processor has the following instruction set operating states controlled by the T bit and J bit in the CPSR.

- A32** The processor executes 32-bit, word-aligned A32 instructions.
- T32** The processor executes 16-bit and 32-bit, halfword-aligned T32 instructions.

The J bit and the T bit determine the instruction set used by the processor. [Table 3-1](#) shows the encoding of these bits.

Table 3-1 CPSR J and T bit encoding

J	T	Instruction set state
0	0	A32
0	1	T32

-
- Note**
-
- The processor does not support Jazelle state. This means there is no processor state where the J bit is 1 and T bit is 0.
 - The processor does not support T32EE state. This means there is no processor state where the J bit is 1 and T bit is 1.
 - Transition between A32 and T32 instruction set states does not affect the processor mode or the register contents.
-

3.2 ARMv8-A architecture concepts

This section introduces both the ARMv8 architectural concepts and the associated terminology. The following sections describe the ARMv8 architectural concepts. Each section introduces the corresponding terms that are used to describe the architecture:

- [Execution state](#).
- [Exception levels on page 3-5](#).
- [Security state on page 3-6](#).
- [Rules for changing execution state on page 3-7](#).
- [Stack pointer selection on page 3-7](#).
- [ARMv8 security model on page 3-8](#).
- [Instruction set state on page 3-10](#).
- [AArch32 execution modes on page 3-10](#).

Note

A thorough understanding of the terminology defined in this section is a prerequisite for reading the remainder of this manual.

3.2.1 Execution state

The execution state defines the processor execution environment, including:

- Supported register widths.
- Supported instruction sets.
- Significant aspects of:
 - The execution model.
 - The *Virtual Memory System Architecture* (VMSA).
 - The programmers model.

The execution states are:

AArch64 The 64-bit execution state. This execution state:

- Features 31 64-bit general purpose registers, with a 64-bit *Program Counter* (PC), *Stack Pointer* (SP), and *Exception Link Registers* (ELRs).
- Provides a single instruction set, A64. For more information, see [Instruction set state on page 3-10](#).
- Defines the ARMv8 exception model, with four exception levels, EL0-EL3, that provide an execution privilege hierarchy.
- Features *Virtual Addresses* (VAs) held in 64-bit registers. The Cortex-A53 VMSA implementation maps these to 40-bit *Physical Address* (PA) maps.
- Defines a number of PSTATE elements that hold processor state. The A64 instruction set includes instructions that operate directly on various PSTATE elements.
- Names each system register using a suffix that indicates the lowest exception level at which the register can be accessed.

AArch32 The 32-bit execution state. This execution state is backwards-compatible with implementations of the ARMv7-A architecture profile that include the Security Extensions and the Virtualization Extensions:

- Features 13 32-bit general purpose registers, and a 32-bit PC, SP, and link register (LR). Some of these registers have multiple banked instances for use in different processor modes.

- Provides two instruction sets, A32 and T32. For more information, see [Instruction set state on page 3-10](#).
- Provides an exception model that maps the ARMv7 exception model onto the ARMv8 exception model and Exception levels. For exceptions taken to an Exception level that is using AArch32, this supports the ARMv7 exception model use of processor *modes*.
- Features 32-bit VAs. The VMSA maps these to PA maps that can support PAs of up to 40 bits.
- Collects processor state into the *Current Program State Register (CPSR)*.

The processor can move between Execution states only on a change of Exception level, and subject to the rules given in [Rules for changing execution state on page 3-7](#). This means different software layers, such as an application, an operating system kernel, and a hypervisor, executing at different Exception levels, can execute in different Execution states.

3.2.2 Exception levels

The ARMv8 exception model defines exception levels EL0-EL3, where:

- EL0 has the lowest software execution privilege, and execution at EL0 is called unprivileged execution.
- Increased exception levels, from 1 to 3, indicate increased software execution privilege.
- EL2 provides support for processor virtualization.
- EL3 provides support for a secure state, see [Security state on page 3-6](#).

The Cortex-A53 processor implements all the Exception levels, EL0-EL3, and supports both Execution states, AArch64 and AArch32, at each Exception level.

Execution can move between Exception levels only on taking an exception, or on returning from an exception:

- On taking an exception, the Exception level either increases or remains the same. The Exception level cannot decrease on taking an exception.
- On returning from an exception, the Exception level either decreases or remains the same. The Exception level cannot increase on returning from an exception.

The Exception level that execution changes to, or remains in, on taking an exception, is called the *target Exception level* of the exception, and:

- Every exception type has a target Exception level that is either:
 - Implicit in the nature of the exception.
 - Defined by configuration bits in the system registers.
- An exception cannot target the EL0 Exception level.

Exception levels, and privilege levels, are defined within a particular Security state, and [ARMv8 security model on page 3-8](#) describes the permitted combinations of Security state and Exception level.

Exception terminology

This section defines terms used to describe the navigation between exception levels.

Terminology for taking an exception

An exception is generated when the processor first responds to an exceptional condition. The processor state at this time is the state the exception is *taken from*. The processor state immediately after taking the exception is the state the exception is *taken to*.

Terminology for returning from an exception

To return from an exception, the processor must execute an exception return instruction. The processor state when an exception return instruction is committed for execution is the state the exception *returns from*. The processor state immediately after the execution of that instruction is the state the exception *returns to*.

Exception level terminology

An Exception level, EL_n, with a larger value of n than another Exception level, is described as being a higher Exception level than the other Exception level. For example, EL3 is a higher Exception level than EL1.

An Exception level with a smaller value of n than another Exception level is described as being a lower Exception level than the other Exception level. For example, EL0 is a lower Exception level than EL1.

An Exception level is described as:

- *Using AArch64* when execution in that Exception level is in the AArch64 Execution state.
- *Using AArch32* when execution in that Exception level is in the AArch32 Execution state.

Typical exception level usage model

The architecture does not specify what software uses the different Exception levels, and such choices are outside the scope of the architecture. However, the following is a common usage model for the Exception levels:

EL0	Applications.
EL1	OS kernel and associated functions that are typically described as <i>privileged</i> .
EL2	Hypervisor.
EL3	Secure monitor.

3.2.3 Security state

An ARMv8 implementation that includes the EL3 Exception level provides the following Security states, each with an associated memory address space:

Secure state

In Secure state, the processor:

- Can access both the Secure memory address space and the Nonsecure memory address space.
- When executing at EL3, can access all the system control resources.

Non-secure state

In Non-secure state, the processor:

- Can access only the Non-secure memory address space.
- Cannot access the Secure system control resources.

The AArch32 Security state model is unchanged from the model for an ARMv7 implementation that includes the Security Extensions and the Virtualization Extensions. When the implementation uses the AArch32 Execution state for all Exception levels, many system registers are banked to provide Secure and Non-secure instances, and:

- The Secure instance is accessible only at EL3.
- The Non-secure instance is accessible at EL1 or higher.
- The two instances of a banked register have the same name.

The *ARMv8 security model on page 3-8* describes how the Security state interacts with other aspects of the ARMv8 architectural state.

3.2.4 Rules for changing execution state

This introduction to moving between execution states does not consider exceptions caused by debug events.

The execution state, AArch64 or AArch32, can change only on a change of exception level, meaning it can change only on either:

- Taking an exception to a higher exception level.
- Returning from an exception to a lower exception level.

———— **Note** —————

The execution state cannot change if, on taking an exception or on returning from an exception, the exception level remains the same.

On taking an exception to a higher exception level, the execution state:

- Can either:
 - Remain the same.
 - Increase from AArch32 state to AArch64 state.
- Cannot decrease from AArch64 state to AArch32 state.

On returning from an exception to a lower exception level, the execution state:

- Can either:
 - Remain the same.
 - Decrease from AArch64 state to AArch32 state.
- Cannot increase from AArch32 state to AArch64 state.

On powerup and on reset, the processor enters EL3, the highest exception level. The execution state for this exception level is a property of the implementation, and is determined by a configuration input signal. For the other exception levels the execution state is determined as follows:

- For an exception return to EL0, the EL0 execution state is specified as part of the exception return, subject to the rules given in this section.
- Otherwise, the execution state is determined by one or more system register configuration bits, that can be set only in a higher exception level.

3.2.5 Stack pointer selection

Stack pointer behavior depends on the execution state, as follows:

AArch64 In EL0, the stack pointer, SP, maps to the SP_EL0 stack pointer register.

Taking an exception selects the default stack pointer for the target exception level, meaning SP maps to the SP_ELx stack pointer register, where x is the exception level.

Software executing in the target exception level can execute an MSR SPSEL, #Imm1 instruction to select whether to use the default SP_ELx stack pointer, or the SP_ELO stack pointer.

The selected stack pointer can be indicated by a suffix to the exception level:

- t** Indicates use of the SP_ELO stack pointer.
- h** Indicates use of the SP_ELx stack pointer.

Table 3-2 shows the set of AArch64 stack pointer options.

Table 3-2 AArch64 stack pointer options

Exception level	AArch64 stack pointer options
EL0	EL0t
EL1	EL1t, EL1h
EL2	EL2t, EL2h
EL3	EL3t, EL3h

AArch32 In AArch32 state, each mode that can be the target of an exception has its own banked copy of the stack pointer. For example, the banked stack pointer for Hyp mode is called SP_hyp. Software executing in one of these modes uses the banked stack pointer for that mode.

The modes that have banked copies of the stack pointer are FIQ mode, IRQ mode, Supervisor mode, Abort mode, Undefined mode, Hyp mode, and Monitor mode. Software executing in User mode or System mode uses the User mode stack pointer, SP_usr.

For more information, see *AArch32 execution modes* on page 3-10.

3.2.6 ARMv8 security model

The Cortex-A53 processor implements all of the exception levels. This means:

- EL3 exists only in Secure state and a change from Secure state to Non-secure state is made only by an exception return from EL3.
- EL2 exists only in Non-secure state.

To provide compatibility with ARMv7, the exception levels available in Secure state are modified when EL3 is using AArch32. The following sections describe the security model:

- *Security model when EL3 is using AArch64.*
- *Security model when EL3 is using AArch32 on page 3-9.*

Security model when EL3 is using AArch64

When EL3 is using AArch64, Figure 3-1 on page 3-9 shows the security model, and the expected use of the different exception levels. This figure shows how instances of EL0 and EL1 are present in both security states.

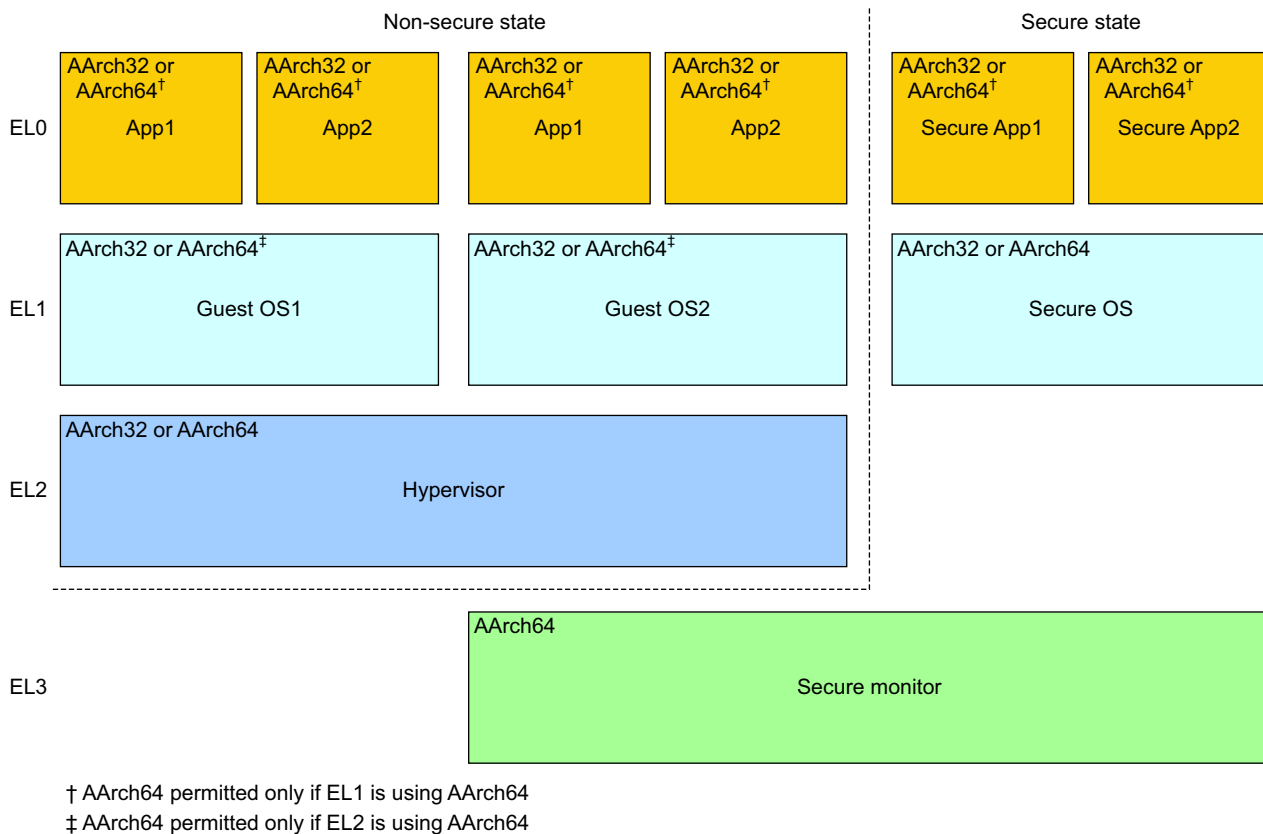

Figure 3-1 ARMv8 security model when EL3 is using AArch64

Security model when EL3 is using AArch32

To provide software compatibility with VMSAv7 implementations that include the security extensions, in Secure AArch32 state, all modes other than User mode have the same execution privilege. This means that, in an implementation where EL3 is using AArch32, the security model is as shown in Figure 3-2 on page 3-10. This figure also shows the expected use of the different exception levels and processor modes.

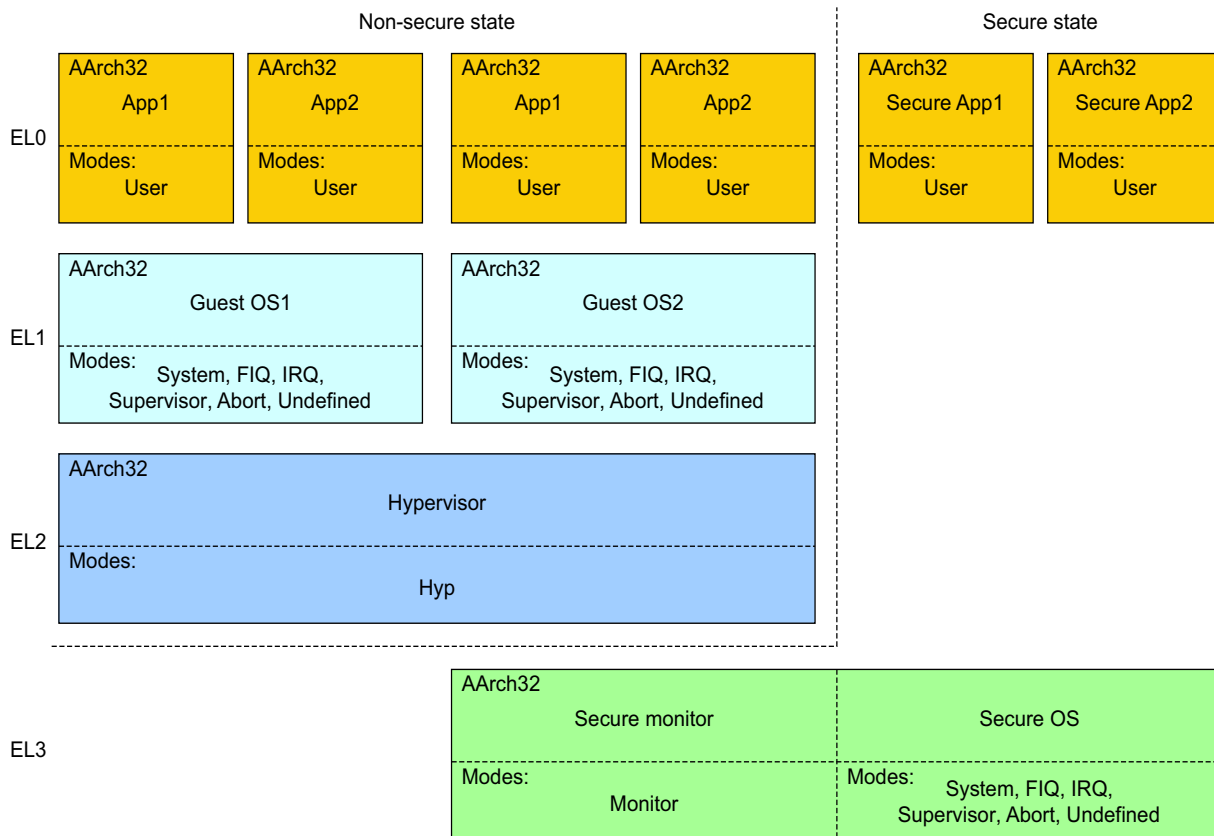

Figure 3-2 ARMv8 security model when EL3 is using AArch32

For more information about the AArch32 processor modes see [AArch32 execution modes](#).

3.2.7 Instruction set state

The processor instruction set state determines the instruction set that the processor executes. The instruction sets depend on the execution state:

- AArch64** AArch64 state supports only a single instruction set, called A64. This is a fixed-width instruction set that uses 32-bit instruction encodings.
- AArch32** AArch32 state supports the following instruction sets:
 - A32** This is a fixed-length instruction set that uses 32-bit instruction encodings. Before the introduction of ARMv8, it was called the ARM instruction set.
 - T32** This is a variable-length instruction set that uses both 16-bit and 32-bit instruction encodings. Before the introduction of ARMv8, it was called the Thumb instruction set state.

3.2.8 AArch32 execution modes

ARMv7 and earlier versions of the ARM architecture define a set of named processor modes, including modes that correspond to different exception types. For compatibility, AArch32 state retains these processor modes.

Table 3-3 shows the AArch32 processor modes, and the exception level of each mode.

Table 3-3 AArch32 processor modes and associated exception levels

AArch32 processor mode	EL3 using	Security state	Exception level
User	AArch32 or AArch64	Non-secure or Secure	EL0
System, FIQ, IRQ, Supervisor,	AArch64	Non-secure or Secure	EL1
Abort, Undefined	AArch32	Non-secure	EL1
		Secure	EL3
Hyp	AArch32 or AArch64	Non-secure only	EL2
Monitor	AArch32	Secure only	EL3

When the *EL3 using* column of Table 3-3 shows:

AArch64 The row refers to information shown in Figure 3-1 on page 3-9.

AArch32 The row refers to information shown in Figure 3-2 on page 3-10.

A processor mode name does not indicate the current security state. To distinguish between a mode in Secure state and the equivalent mode in Non-secure state, the mode name is qualified as Secure or Non-secure. For example, a description of AArch32 operation in EL1 might reference the Secure FIQ mode, or to the Non-secure FIQ mode.

Chapter 4

System Control

This chapter describes the system registers, their structure, operation, and how to use them. It contains the following sections:

- *About system control* on page 4-2
- *AArch64 register summary* on page 4-3.
- *AArch64 register descriptions* on page 4-14.
- *AArch32 register summary* on page 4-135.
- *AArch32 register descriptions* on page 4-157.

4.1 About system control

The system registers control and provides status information for the functions implemented in the processor. The main functions of the system registers are:

- Overall system control and configuration.
- *Memory Management Unit* (MMU) configuration and management.
- Cache configuration and management.
- System performance monitoring.
- GIC configuration and management.

The system registers are accessible in the AArch64 and AArch32 Execution states. The execution states are described in the *ARMv8-A architecture concepts* on page 3-4.

The system registers accessed in the AArch64 Execution state are described in the *AArch64 register descriptions* on page 4-14.

The system registers accessed in the AArch32 Execution state are described in the *AArch32 register descriptions* on page 4-157.

Some of the system registers can be accessed through the memory-mapped or external debug interfaces.

Bits in the system registers that are described in the ARMv7 architecture are redefined in the ARMv8-A architecture:

- UNK/SBZP, RAZ/SBZP, and RAZ/WI are redefined as RES0.
- UNK/SBOP and RAO/SBOP are redefined as RES1.

RES0 and RES1 are described in the *ARM® Architecture Reference Manual ARMv8, for ARMv8-A architecture profile*.

For more information on the execution states, see the *ARM® Architecture Reference Manual ARMv8, for ARMv8-A architecture profile*.

4.1.1 AArch32 registers affected by CP15SDISABLE

In AArch32 state, the **CP15SDISABLE** input disables write access to certain system registers.

The Cortex-A53 processor does not have any IMPLEMENTATION DEFINED registers that are affected by **CP15SDISABLE**.

For a list of registers affected by **CP15SDISABLE**, see the *ARM® Architecture Reference Manual ARMv8, for ARMv8-A architecture profile*.

4.2 AArch64 register summary

This section gives a summary of the system registers in the AArch64 Execution state. For more information on using the system registers, see the *ARM[®] Architecture Reference Manual ARMv8, for ARMv8-A architecture profile*.

The following subsections describe the system registers by functional group:

- [AArch64 identification registers](#).
- [AArch64 exception handling registers](#) on page 4-5.
- [AArch64 virtual memory control registers](#) on page 4-6.
- [AArch64 other system control registers](#) on page 4-7.
- [AArch64 performance monitor registers](#) on page 4-7.
- [AArch64 reset registers](#) on page 4-8.
- [AArch64 secure registers](#) on page 4-9.
- [AArch64 virtualization registers](#) on page 4-9.
- [AArch64 GIC system registers](#) on page 4-10.
- [AArch64 Generic Timer registers](#) on page 4-11.
- [AArch64 thread registers](#) on page 4-11.
- [AArch64 implementation defined registers](#) on page 4-12.
- [AArch64 address registers](#) on page 4-13.

4.2.1 AArch64 identification registers

Table 4-1 shows the identification registers in AArch64 state. Bits[63:32] are reset to 0x00000000 for all 64-bit registers in Table 4-1.

Table 4-1 AArch64 identification registers

Name	Type	Reset	Width	Description
MIDR_EL1	RO	0x410FD032	32	Main ID Register, EL1 on page 4-14
MPIDR_EL1	RO	-a	64	Multiprocessor Affinity Register on page 4-15
REVIDR_EL1	RO	0x00000000	32	Revision ID Register on page 4-16
ID_PFR0_EL1	RO	0x00000131	32	AArch32 Processor Feature Register 0 on page 4-17
ID_PFR1_EL1	RO	0x10011011 ^b	32	AArch32 Processor Feature Register 1 on page 4-18
ID_DFR0_EL1	RO	0x03010066	32	AArch32 Debug Feature Register 0 on page 4-19
ID_AFR0_EL1	RO	0x00000000	32	AArch32 Auxiliary Feature Register 0 on page 4-21
ID_MMFR0_EL1	RO	0x10101105	32	AArch32 Memory Model Feature Register 0 on page 4-21
ID_MMFR1_EL1	RO	0x40000000	32	AArch32 Memory Model Feature Register 1 on page 4-22
ID_MMFR2_EL1	RO	0x01260000	32	AArch32 Memory Model Feature Register 2 on page 4-24
ID_MMFR3_EL1	RO	0x02102211	32	AArch32 Memory Model Feature Register 3 on page 4-26
ID_ISAR0_EL1	RO	0x02101110	32	AArch32 Instruction Set Attribute Register 0 on page 4-28
ID_ISAR1_EL1	RO	0x13112111	32	AArch32 Instruction Set Attribute Register 1 on page 4-29
ID_ISAR2_EL1	RO	0x21232042	32	AArch32 Instruction Set Attribute Register 2 on page 4-30
ID_ISAR3_EL1	RO	0x01112131	32	AArch32 Instruction Set Attribute Register 3 on page 4-33

Table 4-1 AArch64 identification registers (continued)

Name	Type	Reset	Width	Description
ID_ISAR4_EL1	RO	0x00011142	32	<i>AArch32 Instruction Set Attribute Register 4</i> on page 4-34
ID_ISAR5_EL1	RO	0x00011121 ^c	32	<i>AArch32 Instruction Set Attribute Register 5</i> on page 4-36
ID_AA64PFR0_EL1	RO	0x01002222 ^{de}	64	<i>AArch64 Processor Feature Register 0</i> on page 4-37
ID_AA64PFR1_EL1	RO	0x00000000	64	AArch64 Processor Feature Register 1
ID_AA64DFR0_EL1	RO	0x10305106	64	<i>AArch64 Debug Feature Register 0, EL1</i> on page 4-39
ID_AA64DFR1_EL1	RO	0x00000000	64	AArch64 Debug Feature Register 1
ID_AA64AFR0_EL1	RO	0x00000000	64	AArch64 Auxiliary Feature Register 0
ID_AA64AFR1_EL1	RO	0x00000000	64	AArch64 Auxiliary Feature Register 1
ID_AA64ISAR0_EL1	RO	0x00011120 ^f	64	<i>AArch64 Instruction Set Attribute Register 0, EL1</i> on page 4-40
ID_AA64ISAR1_EL1	RO	0x00000000	64	AArch64 Instruction Set Attribute Register 1
ID_AA64MMFR0_EL1	RO	0x00001122	64	<i>AArch64 Memory Model Feature Register 0, EL1</i> on page 4-41
ID_AA64MMFR1_EL1	RO	0x00000000	64	AArch64 Memory Model Feature Register 1
CCSIDR_EL1	RO	- ^g	32	<i>Cache Size ID Register</i> on page 4-43
CLIDR_EL1	RO	0x0A200023 ^h	32	<i>Cache Level ID Register</i> on page 4-44
AIDR_EL1	RO	0x00000000	32	<i>Auxiliary ID Register</i> on page 4-45
CSSELR_EL1	RW	0x00000000	32	<i>Cache Size Selection Register</i> on page 4-45
CTR_EL0	RO	0x84448004	32	<i>Cache Type Register</i> on page 4-47
DCZID_EL0	RO	0x00000004	32	<i>Data Cache Zero ID Register</i> on page 4-48
VPIDR_EL2	RW	0x410FD032	32	<i>Virtualization Processor ID Register</i> on page 4-49
VMPIDR_EL2	RO	- ⁱ	64	<i>Virtualization Multiprocessor ID Register</i> on page 4-50

- a. The reset value depends on the primary inputs, CLUSTERIDAFF1 and CLUSTERIDAFF2, and the number of cores that the device implements.
- b. Bits [31:28] are 0x1 if the GIC CPU interface is enabled, and 0x0 otherwise.
- c. ID_ISAR5_EL1 has the value 0x00010001 if the Cryptography Extension is not implemented and enabled.
- d. Bits [27:24] are 0x1 if the GIC CPU interface is enabled, and 0x0 otherwise.
- e. Bits [23:16] are 0x00 if the Advanced SIMD and Floating-point Extension is implemented, and 0xFF otherwise.
- f. ID_AA64ISAR0_EL1 has the value 0x00010000 if the Cryptography Extension is not implemented and enabled.
- g. The reset value depends on the implementation. See the register description for details.
- h. The value is 0x09200003 if the L2 cache is not implemented.
- i. The reset value is the value of the Multiprocessor Affinity Register.

4.2.2 AArch64 exception handling registers

Table 4-2 shows the fault handling registers in AArch64 state. Bits[63:32] are reset to 0x00000000 for all 64-bit registers in Table 4-2.

Table 4-2 AArch64 exception handling registers

Name	Type	Reset	Width	Description
AFSR0_EL1	RW	0x00000000	32	<i>Auxiliary Fault Status Register 0, EL1, EL2 and EL3 on page 4-97</i>
AFSR1_EL1	RW	0x00000000	32	<i>Auxiliary Fault Status Register 1, EL1, EL2 and EL3 on page 4-97</i>
ESR_EL1	RW	UNK	32	<i>Exception Syndrome Register, EL1 on page 4-97</i>
IFSR32_EL2	RW	UNK	32	<i>Instruction Fault Status Register, EL2 on page 4-98</i>
AFSR0_EL2	RW	0x00000000	32	<i>Auxiliary Fault Status Register 0, EL1, EL2 and EL3 on page 4-97</i>
AFSR1_EL2	RW	0x00000000	32	<i>Auxiliary Fault Status Register 1, EL1, EL2 and EL3 on page 4-97</i>
ESR_EL2	RW	UNK	32	<i>Exception Syndrome Register, EL2 on page 4-101</i>
AFSR0_EL3	RW	0x00000000	32	<i>Auxiliary Fault Status Register 0, EL1, EL2 and EL3 on page 4-97</i>
AFSR1_EL3	RW	0x00000000	32	<i>Auxiliary Fault Status Register 1, EL1, EL2 and EL3 on page 4-97</i>
ESR_EL3	RW	UNK	32	<i>Exception Syndrome Register, EL3 on page 4-102</i>
FAR_EL1	RW	UNK	64	<i>Fault Address Register, EL1 on page 4-103</i>
FAR_EL2	RW	UNK	64	<i>Fault Address Register, EL2 on page 4-104</i>
HPFAR_EL2	RW	0x00000000	64	<i>Hypervisor IPA Fault Address Register, EL2 on page 4-105</i>
FAR_EL3	RW	UNK	64	<i>Fault Address Register, EL3 on page 4-111</i>
VBAR_EL1	RW	UNK	64	<i>Vector Base Address Register, EL1 on page 4-119</i>
ISR_EL1	RO	UNK	32	<i>Interrupt Status Register on page 4-123</i>
VBAR_EL2	RW	UNK	64	<i>Vector Base Address Register, EL2 on page 4-120</i>
VBAR_EL3	RW	UNK	64	<i>Vector Base Address Register, EL3 on page 4-121</i>

4.2.3 AArch64 virtual memory control registers

Table 4-3 shows the virtual memory control registers in AArch64 state. Bits[63:32] are reset to 0x00000000 for all 64-bit registers in Table 4-3.

Table 4-3 AArch64 virtual memory control registers

Name	Type	Reset	Width	Description
SCTLR_EL1	RW	0x00C50838 ^a	32	<i>System Control Register, EL1</i> on page 4-50
SCTLR_EL2	RW	0x30C50838 ^b	32	<i>System Control Register, EL2</i> on page 4-58
SCTLR_EL3	RW	0x00C50838 ^a	32	<i>System Control Register, EL3</i> on page 4-74
TTBR0_EL1	RW	UNK	64	<i>Translation Table Base Register 0, EL1</i> on page 4-79
TTBR1_EL1	RW	UNK	64	<i>Translation Table Base Register 1</i> on page 4-80
TCR_EL1	RW	UNK	64	<i>Translation Control Register, EL1</i> on page 4-86
TTBR0_EL2	RW	UNK	64	Translation Table Base Address Register 0, EL2 ^c
TCR_EL2	RW	UNK	32	<i>Translation Control Register, EL2</i> on page 4-89
VTTBR_EL2	RW	UNK	64	Virtualization Translation Table Base Address Register, EL2 ^c
VTCR_EL2	RW	UNK	32	<i>Virtualization Translation Control Register, EL2</i> on page 4-91
TTBR0_EL3	RW	UNK	64	<i>Translation Table Base Register 0, EL3</i> on page 4-93
TCR_EL3	RW	UNK	32	<i>Translation Control Register, EL3</i> on page 4-94
MAIR_EL1	RW	UNK	64	<i>Memory Attribute Indirection Register, EL1</i> on page 4-116
AMAIR_EL1	RW	0x00000000	64	<i>Auxiliary Memory Attribute Indirection Register, EL1, EL2 and EL3</i> on page 4-97
MAIR_EL2	RW	UNK	64	<i>Memory Attribute Indirection Register, EL2</i> on page 4-118
AMAIR_EL2	RW	0x00000000	64	<i>Auxiliary Memory Attribute Indirection Register, EL1, EL2 and EL3</i> on page 4-97
MAIR_EL3	RW	UNK	64	<i>Memory Attribute Indirection Register, EL3</i> on page 4-118
AMAIR_EL3	RW	0x00000000	64	<i>Auxiliary Memory Attribute Indirection Register, EL1, EL2 and EL3</i> on page 4-97
CONTEXTIDR_EL1	RW	UNK	32	Context ID Register, EL1 ^c

- The reset value depends on primary inputs **CFGTE** and **CFGEND**. Table 4-3 assumes these signals are LOW.
- The reset value depends on primary inputs **CFGTE**, **CFGEND** and **VINITHI**. Table 4-3 assumes these signals are LOW.
- See the *ARM® Architecture Reference Manual ARMv8, for ARMv8-A architecture profile*.

4.2.4 AArch64 other system control registers

Table 4-4 shows the other system control registers in AArch64 state.

Table 4-4 AArch64 other system control registers

Name	Type	Reset	Width	Description
ACTLR_EL1	RW	0x00000000	32	<i>Auxiliary Control Register, EL1 on page 4-55</i>
CPACR_EL1	RW	0x00000000	32	<i>Architectural Feature Access Control Register on page 4-57</i>
ACTLR_EL2	RW	0x00000000	32	<i>Auxiliary Control Register, EL2 on page 4-55</i>
ACTLR_EL3	RW	0x00000000	32	<i>Auxiliary Control Register, EL3 on page 4-56</i>

4.2.5 AArch64 performance monitor registers

Table 4-5 shows the performance monitor registers in AArch64 state. Bits[63:32] are reset to 0x00000000 for all 64-bit registers in Table 4-5.

Table 4-5 AArch64 performance monitor registers

Name	Type	Reset	Width	Description
PMCR_EL0	RW	0x41033000	32	<i>Performance Monitors Control Register on page 12-7</i>
PMCNSET_EL0	RW	UNK	32	Performance Monitors Count Enable Set Register ^a
PMCNCLR_EL0	RW	UNK	32	Performance Monitors Count Enable Clear Register ^a
PMOVSCLR_EL0	RW	UNK	32	Performance Monitors Overflow Flag Status Clear Register ^a
PMSWINC_EL0	WO	-	32	Performance Monitors Software Increment Register ^a
PMSELR_EL0	RW	UNK	32	Performance Monitors Event Counter Selection Register ^a
PMCEID0_EL0	RO	0x67FFBFFF ^b	32	<i>Performance Monitors Common Event Identification Register 0 on page 12-9</i>
PMCEID1_EL0	RO	0x00000000	32	<i>Performance Monitors Common Event Identification Register 1 on page 12-12^a</i>
PMCCNTR_EL0	RW	UNK	64	Performance Monitors Cycle Counter ^a
PMXEVTYPER_EL0	RW	UNK	32	Performance Monitors Selected Event Type and Filter Register ^a
PMXEVCNTR_EL0	RW	UNK	32	Performance Monitors Selected Event Counter Register ^a
PMUSERENR_EL0	RW	0x00000000	32	Performance Monitors User Enable Register ^a
PMINTENSET_EL1	RW	UNK	32	Performance Monitors Interrupt Enable Set Register ^a
PMINTENCLR_EL1	RW	UNK	32	Performance Monitors Interrupt Enable Clear Register ^a
PMOVSSET_EL0	RW	UNK	32	Performance Monitors Overflow Flag Status Set Register ^a

Table 4-5 AArch64 performance monitor registers (continued)

Name	Type	Reset	Width	Description
PMEVCNTR0_EL0	RW	UNK	32	Performance Monitor Event Count Registers
PMEVCNTR1_EL0	RW	UNK	32	
PMEVCNTR2_EL0	RW	UNK	32	
PMEVCNTR3_EL0	RW	UNK	32	
PMEVCNTR4_EL0	RW	UNK	32	
PMEVCNTR5_EL0	RW	UNK	32	
PMEVTYPER0_EL0	RW	UNK	32	Performance Monitor Event Type Registers
PMEVTYPER1_EL0	RW	UNK	32	
PMEVTYPER2_EL0	RW	UNK	32	
PMEVTYPER3_EL0	RW	UNK	32	
PMEVTYPER4_EL0	RW	UNK	32	
PMEVTYPER5_EL0	RW	UNK	32	
PMCCFILTR_EL0	RW	0x00000000	32	Performance Monitors Cycle Count Filter Register ^a

a. See the *ARM® Architecture Reference Manual ARMv8, for ARMv8-A architecture profile* for more information.

b. The reset value is 0x663FBFFF if the Cortex-A53 processor has not been configured with an L2 cache.

4.2.6 AArch64 reset registers

Table 4-6 shows the reset registers in AArch64 state.

Table 4-6 AArch64 reset management registers

Name	Type	Reset	Width	Description
RVBAR_EL3	RO	- ^a	64	<i>Reset Vector Base Address Register, EL3</i> on page 4-121
RMR_EL3	RW	0x00000001	32	<i>Reset Management Register</i> on page 4-122

a. The reset value depends on the **RVBARADDR** signal.

4.2.7 AArch64 secure registers

Table 4-7 shows the secure registers in AArch64 state.

Table 4-7 AArch64 security registers

Name	Type	Reset	Width	Description
SCR_EL3	RW	0x00000000	32	<i>Secure Configuration Register on page 4-76</i>
SDER32_EL3	RW	0x00000000	32	<i>Secure Debug Enable Register on page 4-78</i>
CPTR_EL3	RW	0x00000000 ^a	32	<i>Architectural Feature Trap Register, EL3 on page 4-81</i>
MDCR_EL3	RW	0x00000000	32	<i>Monitor Debug Configuration Register, EL3 on page 4-82</i>
AFSR0_EL3	RW	0x00000000	32	<i>Auxiliary Fault Status Register 0, EL1, EL2 and EL3 on page 4-97</i>
AFSR1_EL3	RW	0x00000000	32	<i>Auxiliary Fault Status Register 1, EL1, EL2 and EL3 on page 4-97</i>
VBAR_EL3	RW	0x0000000000000000	64	<i>Vector Base Address Register, EL3 on page 4-121</i>

a. Reset value is 0x00000000 if Advanced SIMD and Floating point are implemented, 0x00000400 otherwise.

4.2.8 AArch64 virtualization registers

Table 4-8 shows the virtualization registers in AArch64 state. Bits[63:32] are reset to 0x00000000 for all 64-bit registers in Table 4-8.

Table 4-8 AArch64 virtualization registers

Name	Type	Reset	Width	Description
VPIDR_EL2	RW	0x410FD031	32	<i>Virtualization Processor ID Register on page 4-49</i>
VMPIDR_EL2	RW	.. ^a	64	<i>Virtualization Multiprocessor ID Register on page 4-50</i>
SCTLR_EL2	RW	0x30C50838 ^b	32	<i>System Control Register, EL2 on page 4-58</i>
ACTLR_EL2	RW	0x00000000	32	<i>Auxiliary Control Register, EL2 on page 4-55</i>
HCR_EL2	RW	0x00000000	64	<i>Hypervisor Configuration Register on page 4-60</i>
MDCR_EL2	RW	0x00000006	32	<i>Hyp Debug Control Register on page 4-66</i>
CPTR_EL2	RW	0x000033FF ^c	32	<i>Architectural Feature Trap Register, EL2 on page 4-69</i>
HSTR_EL2	RW	0x00000000	32	<i>Hyp System Trap Register on page 4-70</i>
HACR_EL2	RW	0x00000000	32	<i>Hyp Auxiliary Configuration Register on page 4-74</i>
TTBR0_EL2	RW	UNK	64	Translation Table Base Address Register 0, EL3 ^d
TCR_EL2	RW	UNK	32	<i>Translation Control Register, EL2 on page 4-89</i>
VTTBR_EL2	RW	UNK	64	Virtualization Translation Table Base Address Register, EL2 ^d

Table 4-8 AArch64 virtualization registers (continued)

Name	Type	Reset	Width	Description
VTCR_EL2	RW	UNK	32	<i>Virtualization Translation Control Register, EL2 on page 4-91</i>
DACR32_EL2	RW	UNK	32	<i>Domain Access Control Register on page 4-92</i>
AFSR0_EL2	RW	0x00000000	32	<i>Auxiliary Fault Status Register 0, EL1, EL2 and EL3 on page 4-97</i>
AFSR1_EL2	RW	0x00000000	32	<i>Auxiliary Fault Status Register 1, EL1, EL2 and EL3 on page 4-97</i>
ESR_EL2	RW	UNK	32	<i>Exception Syndrome Register, EL2 on page 4-101</i>
FAR_EL2	RW	UNK	64	<i>Fault Address Register, EL2 on page 4-104</i>
HPFAR_EL2	RW	UNK	64	<i>Hypervisor IPA Fault Address Register, EL2 on page 4-105</i>
MAIR_EL2	RW	UNK	64	<i>Memory Attribute Indirection Register, EL2 on page 4-118</i>
AMAIR_EL2	RW	0x00000000	64	<i>Auxiliary Memory Attribute Indirection Register, EL1, EL2 and EL3 on page 4-97</i>
VBAR_EL2	RW	UNK	64	<i>Vector Base Address Register, EL2 on page 4-120</i>

- The reset value is the value of the Multiprocessor Affinity Register.
- The reset value depends on inputs, **CFGTE** and **CFGEND**. The value shown assumes these signals are set to LOW.
- Reset value is 0x0000BFFF if Advanced SIMD and Floating-point are not implemented.
- See the *ARM® Architecture Reference Manual ARMv8, for ARMv8-A architecture profile* for more information.

4.2.9 AArch64 GIC system registers

Table 4-9 shows the GIC system registers in AArch64 state. See the *ARM® Architecture Reference Manual ARMv8, for ARMv8-A architecture profile* for more information.

Table 4-9 GIC system registers

Name	Type	Reset	Width	Description
ICC_AP0R0_EL1	RW	0x00000000	32	Active Priorities 0 Register 0
ICC_AP1R0_EL1	RW	0x00000000	32	Active Priorities 1 Register 0
ICC_ASGI1R_EL1	WO	-	64	Alternate SGI Generation Register 1
ICC_BPR0_EL1	RW	0x00000002	32	Binary Point Register 0
ICC_BPR1_EL1	RW	0x00000003 ^a	32	Binary Point Register 1
ICC_CTLR_EL1	RW	0x00000400	32	Interrupt Control Register for EL1
ICC_CTLR_EL3	RW	0x00000400	32	Interrupt Control Register for EL3
ICC_DIR_EL1	WO	-	32	Deactivate Interrupt Register
ICC_EOIR0_EL1	WO	-	32	End Of Interrupt Register 0
ICC_EOIR1_EL1	WO	-	32	End Of Interrupt Register 1
ICC_HPPIR0_EL1	RO	-	32	Highest Priority Pending Interrupt Register 0
ICC_HPPIR1_EL1	RO	-	32	Highest Priority Pending Interrupt Register 1
ICC_IAR0_EL1	RO	-	32	Interrupt Acknowledge Register 0
ICC_IAR1_EL1	RO	-	32	Interrupt Acknowledge Register 1

Table 4-9 GIC system registers (continued)

Name	Type	Reset	Width	Description
ICC_IGRPEN0_EL1	RW	0x00000000	32	Interrupt Group Enable Register 0
ICC_IGRPEN1_EL1	RW	0x00000000	32	Interrupt Group Enable Register 1
ICC_IGRPEN1_EL3	RW	0x00000000	32	Interrupt Group Enable Register 1 for EL3
ICC_PMR_EL1	RW	0x00000000	32	Priority Mask Register
ICC_RPR_EL1	RO	-	32	Running Priority Register
ICC_SEIEN_EL1	RW	0x00000000	32	System Error Interrupt Enable Register
ICC_SGI0R_EL1	WO	-	64	SGI Generation Register 0
ICC_SGI1R_EL1	WO	-	64	SGI Generation Register 1
ICC_SRE_EL1	RW	0x00000000	32	System Register Enable Register for EL1
ICC_SRE_EL2	RW	0x00000000	32	System Register Enable Register for EL2
ICC_SRE_EL3	RW	0x00000000	32	System Register Enable Register for EL3

a. This is the reset value in non-secure states. In secure states, the reset value is 0x00000002.

4.2.10 AArch64 Generic Timer registers

See [Chapter 10 Generic Timer](#) for information on the Generic Timer registers.

4.2.11 AArch64 thread registers

[Table 4-10](#) shows the thread registers in AArch64 state. See the *ARM® Architecture Reference Manual ARMv8, for ARMv8-A architecture profile* for more information about these operations.

Table 4-10 AArch64 miscellaneous system control operations

Name	Type	Reset	Width	Description
TPIDR_EL0	RW	UNK	64	Thread Pointer/ID Register, EL0
TPIDR_EL1	RW	UNK	64	Thread Pointer/ID Register, EL1
TPIDRRO_EL0	RW	UNK	64	Thread Pointer/ID Register, Read-Only, EL0
TPIDR_EL2	RW	UNK	64	Thread Pointer/ID Register, EL2
TPIDR_EL3	RW	UNK	64	Thread Pointer/ID Register, EL3

4.2.12 AArch64 implementation defined registers

Table 4-11 shows the IMPLEMENTATION DEFINED registers in AArch64 state. These registers provide test features and any required configuration options specific to the Cortex-A53 processor. If a register is not indicated as mapped to an AArch32 64-bit register, bits[63:32] are 0x00000000.

Table 4-11 AArch64 implementation defined registers

Name	Type	Reset	Width	Description
ACTLR_EL1	RW	0x00000000	32	<i>Auxiliary Control Register, EL1 on page 4-55</i>
ACTLR_EL2	RW	0x00000000	32	<i>Auxiliary Control Register, EL2 on page 4-55</i>
ACTLR_EL3	RW	0x00000000	32	<i>Auxiliary Control Register, EL3 on page 4-56</i>
AFSR0_EL1	RW	0x00000000	32	<i>Auxiliary Fault Status Register 0, EL1, EL2 and EL3 on page 4-97</i>
AFSR1_EL1	RW	0x00000000	32	<i>Auxiliary Fault Status Register 1, EL1, EL2 and EL3 on page 4-97</i>
AFSR0_EL2	RW	0x00000000	32	<i>Auxiliary Fault Status Register 0, EL1, EL2 and EL3 on page 4-97</i>
AFSR1_EL2	RW	0x00000000	32	<i>Auxiliary Fault Status Register 1, EL1, EL2 and EL3 on page 4-97</i>
AFSR0_EL3	RW	0x00000000	32	<i>Auxiliary Fault Status Register 0, EL1, EL2 and EL3 on page 4-97</i>
AFSR1_EL3	RW	0x00000000	32	<i>Auxiliary Fault Status Register 1, EL1, EL2 and EL3 on page 4-97</i>
AMAIR_EL1	RW	0x00000000	64	<i>Auxiliary Memory Attribute Indirection Register, EL1, EL2 and EL3 on page 4-97</i>
AMAIR_EL2	RW	0x00000000	64	<i>Auxiliary Memory Attribute Indirection Register, EL1, EL2 and EL3 on page 4-97</i>
AMAIR_EL3	RW	0x00000000	64	<i>Auxiliary Memory Attribute Indirection Register, EL1, EL2 and EL3 on page 4-97</i>
L2CTLR_EL1	RW	..a	32	<i>L2 Control Register on page 4-106</i>
L2ECTLR_EL1	RW	0x00000000	32	<i>L2 Extended Control Register on page 4-107</i>
L2ACTLR_EL1	RW	0x80000000 ^b	32	<i>L2 Auxiliary Control Register on page 4-109</i>
CPUACTLR_EL1 ^c	RW	0x00000000004C8000	64	<i>CPU Auxiliary Control Register, EL1 on page 4-124</i>
CPUECTLR_EL1 ^c	RW	0x0000000000000000	64	<i>CPU Extended Control Register, EL1 on page 4-128</i>
CPUMERRSR_EL1 ^c	RW	-	64	<i>CPU Memory Error Syndrome Register on page 4-129</i>
L2MERRSR_EL1 ^c	RW	-	64	<i>L2 Memory Error Syndrome Register on page 4-132</i>
CBAR_EL1	RO	..d	64	<i>Configuration Base Address Register, EL1 on page 4-134</i>

- The reset value depends on the processor implementation and the state of the **L2RSTDISABLE** signal.
- This is the reset value for an ACE interface. For a CHI interface the reset value is 0x80004008.
- Mapped to a 64-bit AArch32 register.
- The reset value depends on the **PERIPBASE** signal.

4.2.13 AArch64 address registers

Table 4-12 shows the address translation register in AArch64 state.

Table 4-12 AArch64 address translation register

Name	Type	Reset	Width	Description
PAR_EL1	RW	UNK	64	<i>Physical Address Register, EL1</i> on page 4-112

4.3 AArch64 register descriptions

This section describes all the system registers, in register number order, when the system is in the AArch64 Execution state. Table 4-1 on page 4-3 to Table 4-11 on page 4-12 provide cross-references to individual registers.

4.3.1 Main ID Register, EL1

The MIDR_EL1 characteristics are:

Purpose Provides identification information for the processor, including an implementer code for the device and a device ID number.

Usage constraints This register is accessible as follows:

EL0	EL1 (NS)	EL1 (S)	EL2	EL3 (SCR.NS = 1)	EL3 (SCR.NS = 0)
-	RO	RO	RO	RO	RO

Configurations The MIDR_EL1 is:

- Architecturally mapped to the AArch32 MIDR register. See [Main ID Register on page 4-157](#).
- Architecturally mapped to external MIDR_EL1 register.

Attributes MIDR_EL1 is a 32-bit register.

Figure 4-1 shows the MIDR_EL1 bit assignments.

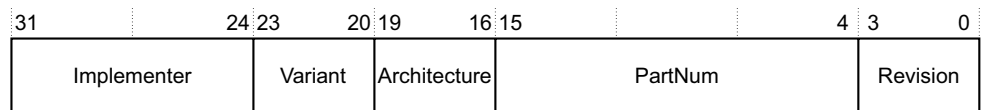

Figure 4-1 MIDR_EL1 bit assignments

Table 4-13 shows the MIDR_EL1 bit assignments.

Table 4-13 MIDR_EL1 bit assignments

Bits	Name	Function
[31:24]	Implementer	Indicates the implementer code. This value is: 0x41 ASCII character 'A' - implementer is ARM.
[23:20]	Variant	Indicates the variant number of the processor. This is the major revision number x in the rx part of the $rxpy$ description of the product revision status. This value is: 0x0 r0p2.
[19:16]	Architecture	Indicates the architecture code. This value is: 0xF Defined by CPUID scheme.
[15:4]	PartNum	Indicates the primary part number. This value is: 0xD03 Cortex-A53 processor.
[3:0]	Revision	Indicates the minor revision number of the processor. This is the minor revision number y in the $rxpy$ part of the $rxpy$ description of the product revision status. This value is: 0x2 r0p2.

To access the MIDR_EL1:

MRS <Xt>, MIDR_EL1 ; Read MIDR_EL1 into Xt

Table 4-14 shows the register access encoding:

Table 4-14 MIDR_EL1 access encoding

op0	op1	CRn	CRm	op2
11	000	0000	0000	000

The MIDR_EL1 can be accessed through the memory-mapped interface and the external debug interface, offset 0xD00.

4.3.2 Multiprocessor Affinity Register

The MPIDR_EL1 characteristics are:

Purpose Provides an additional core identification mechanism for scheduling purposes in a cluster system.

Usage constraints This register is accessible as follows:

EL0	EL1 (NS)	EL1 (S)	EL2	EL3 (SCR.NS = 1)	EL3 (SCR.NS = 0)
-	RO	RO	RO	RO	RO

Configurations The MPIDR_EL1[31:0] is:

- Architecturally mapped to the AArch32 MPIDR register. See [Multiprocessor Affinity Register](#) on page 4-158.
- Mapped to external EDDEVAFF0 register.

MPIDR_EL1[63:32] is mapped to external EDDEVAFF1 register.

Attributes MPIDR_EL1 is a 64-bit register.

Figure 4-2 shows the MPIDR_EL1 bit assignments.

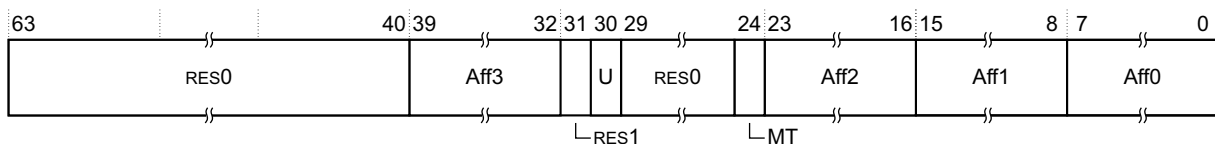

Figure 4-2 MPIDR_EL1 bit assignments

Table 4-15 shows the MPIDR_EL1 bit assignments.

Table 4-15 MPIDR_EL1 bit assignments

Bits	Name	Function
[63:40]	-	Reserved, RES0.
[39:32]	Aff3	Affinity level 3. Highest level affinity field. Reserved, RES0.
[31]	-	Reserved, RES1.
[30]	U	Indicates a single core system, as distinct from core 0 in a cluster. This value is: 0 Core is part of a cluster.
[29:25]	-	Reserved, RES0.
[24]	MT	Indicates whether the lowest level of affinity consists of logical cores that are implemented using a multi-threading type approach. This value is: 0 Performance of cores at the lowest affinity level is largely independent.
[23:16]	Aff2	Affinity level 2. Second highest level affinity field. Indicates the value read in the CLUSTERIDAFF2 configuration signal.
[15:8]	Aff1	Affinity level 1. Third highest level affinity field. Indicates the value read in the CLUSTERIDAFF1 configuration signal.
[7:0]	Aff0	Affinity level 0. Lowest level affinity field. Indicates the core number in the Cortex-A53 processor. The possible values are: 0x0 A cluster with one core only. 0x0, 0x1 A cluster with two cores. 0x0, 0x1, 0x2 A cluster with three cores. 0x0, 0x1, 0x2, 0x3 A cluster with four cores.

To access the MPIDR_EL1:

MRS <Xt>, MPIDR_EL1 ; Read MPIDR_EL1 into Xt

Register access is encoded as follows:

Table 4-16 MPIDR access encoding

op0	op1	CRn	CRm	op2
11	000	0000	0000	101

The EDDEVAFF0 and EDDEVAFF1 can be accessed through the internal memory-mapped interface and the external debug interface, offsets 0xFA8 and 0xFAC respectively.

4.3.3 Revision ID Register

The REVIDR_EL1 characteristics are:

Purpose Provides implementation-specific minor revision information that can be interpreted only in conjunction with the Main ID Register.

Usage constraints This register is accessible as follows:

EL0	EL1 (NS)	EL1 (S)	EL2	EL3 (SCR.NS = 1)	EL3 (SCR.NS = 0)
-	RO	RO	RO	RO	RO

Configurations REVIDR_EL1 is architecturally mapped to AArch32 register REVIDR. See [Revision ID Register on page 4-159](#).

Attributes REVIDR_EL1 is a 32-bit register.

Figure 4-3 shows the REVIDR_EL1 bit assignments.

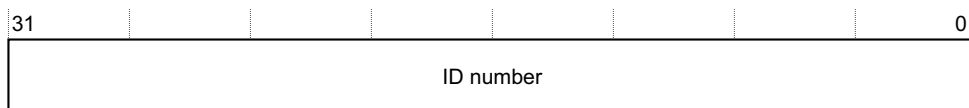

Figure 4-3 REVIDR_EL1 bit assignments

Table 4-17 shows the REVIDR_EL1 bit assignments.

Table 4-17 REVIDR_EL1 bit assignments

Bits	Name	Function
[31:0]	ID number	Implementation-specific revision information. The reset value is determined by the specific Cortex-A53 MPCore implementation. 0x00000000 Revision code is zero.

To access the REVIDR_EL1:

MRS <Xt>, REVIDR_EL1 ; Read REVIDR_EL1 into Xt

Register access is encoded as follows:

Table 4-18 REVIDR_EL1 access encoding

op0	op1	CRn	CRm	op2
11	000	0000	0000	110

4.3.4 AArch32 Processor Feature Register 0

The ID_PFR0_EL1 characteristics are:

Purpose Gives top-level information about the instruction sets supported by the processor in AArch32.

Usage constraints This register is accessible as follows:

EL0	EL1 (NS)	EL1 (S)	EL2	EL3 (SCR.NS = 1)	EL3 (SCR.NS = 0)
-	RO	RO	RO	RO	RO

Configurations ID_PFR1_EL1 is architecturally mapped to AArch32 register ID_PFR1. See *Processor Feature Register 1* on page 4-162.

Attributes ID_PFR1_EL1 is a 32-bit register.

Figure 4-5 shows the ID_PFR1_EL1 bit assignments.

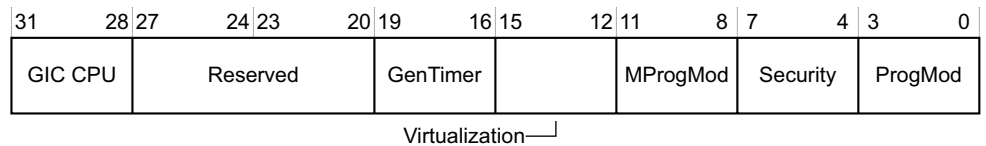

Figure 4-5 ID_PFR1_EL1 bit assignments

Table 4-21 shows the ID_PFR1_EL1 bit assignments.

Table 4-21 ID_PFR1_EL1 bit assignments

Bits	Name	Function
[31:28]	GIC CPU	GIC CPU support: 0x0 GIC CPU interface is disabled, GICCDISABLE is HIGH. 0x1 GIC CPU interface is enabled.
[27:20]	-	Reserved, RES0.
[19:16]	GenTimer	Generic Timer support: 0x1 Generic Timer supported.
[15:12]	Virtualization	Virtualization support: 0x1 Virtualization implemented.
[11:8]	MProgMod	M profile programmers' model support: 0x0 Not supported.
[7:4]	Security	Security support: 0x1 Security implemented. This includes support for Monitor mode and the SMC instruction.
[3:0]	ProgMod	Indicates support for the standard programmers model for ARMv4 and later. Model must support User, FIQ, IRQ, Supervisor, Abort, Undefined, and System modes: 0x1 Supported.

To access the ID_PFR1_EL1:

MRS <Xt>, ID_PFR1_EL1 ; Read ID_PFR1_EL1 into Xt

Register access is encoded as follows:

Table 4-22 REVIDR access encoding

op0	op1	CRn	CRm	op2
1111	000	0000	0001	001

4.3.6 AArch32 Debug Feature Register 0

The ID_DFR0_EL1 characteristics are:

Purpose Provides top level information about the debug system in AArch32.

Usage constraints This register is accessible as follows:

EL0	EL1 (NS)	EL1 (S)	EL2	EL3 (SCR.NS = 1)	EL3 (SCR.NS = 0)
-	RO	RO	RO	RO	RO

Configurations ID_DFR0_EL1 is architecturally mapped to AArch32 register ID_DFR0. See [Debug Feature Register 0 on page 4-163](#).

Attributes ID_DFR0_EL1 is a 32-bit register.

Figure 4-6 shows the ID_DFR0_EL1 bit assignments.

31	28	27	24	23	20	19	16	15	12	11	8	7	4	3	0
RES0		PerfMon		MProfDbg		MMapTrc		CopTrc		Reserved		CopSDBG		CopDbg	

Figure 4-6 ID_DFR0_EL1 bit assignments

Table 4-23 shows the ID_DFR0_EL1 bit assignments.

Table 4-23 ID_DFR0_EL1 bit assignments

Bits	Name	Function
[31:28]	-	Reserved, RES0.
[27:24]	PerfMon	Indicates support for performance monitor model: 0x3 Support for <i>Performance Monitor Unit version 3</i> (PMUv3) system registers.
[23:20]	MProfDbg	Indicates support for memory-mapped debug model for M profile processors: 0x0 Processor does not support M profile Debug architecture.
[19:16]	MMapTrc	Indicates support for memory-mapped trace model: 0x1 Support for ARM trace architecture, with memory-mapped access. In the Trace registers, the ETMIDR gives more information about the implementation.
[15:12]	CopTrc	Indicates support for coprocessor-based trace model: 0x0 Processor does not support ARM trace architecture with CP14 access.
[11:8]	-	Reserved, RES0.
[7:4]	CopSDBG	Indicates support for coprocessor-based Secure debug model: 0x6 Processor supports v8 Debug architecture, with CP14 access.
[3:0]	CopDbg	Indicates support for coprocessor-based debug model: 0x6 Processor supports v8 Debug architecture, with CP14 access.

To access the ID_DFR0_EL1:

MRS <Xt>, ID_DFR0_EL1 ; Read ID_DFR0_EL1 into Xt

Register access is encoded as follows:

Table 4-24 REVIDR access encoding

op0	op1	CRn	CRm	op2
1111	000	0000	0001	010

4.3.7 AArch32 Auxiliary Feature Register 0

This register is always RES0.

4.3.8 AArch32 Memory Model Feature Register 0

The ID_MMFR0_EL1 characteristics are:

Purpose Provides information about the memory model and memory management support in AArch32.

Usage constraints This register is accessible as follows:

EL0	EL1 (NS)	EL1 (S)	EL2	EL3 (SCR.NS = 1)	EL3 (SCR.NS = 0)
-	RO	RO	RO	RO	RO

Configurations ID_MMFR0_EL1 is architecturally mapped to AArch32 register ID_MMFR0. See [Memory Model Feature Register 0 on page 4-165](#).

Attributes ID_MMFR0_EL1 is a 32-bit register.

[Figure 4-7](#) shows the ID_MMFR0_EL1 bit assignments.

31	28	27	24	23	20	19	16	15	12	11	8	7	4	3	0
InnerShr		FCSE		AuxReg		TCM		ShareLvl		OuterShr		PMSA		VMSA	

Figure 4-7 ID_MMFR0_EL1 bit assignments

Table 4-25 shows the ID_MMFR0_EL1 bit assignments.

Table 4-25 ID_MMFR0_EL1 bit assignments

Bits	Name	Function
[31:28]	InnerShr	Indicates the innermost shareability domain implemented: 0x1 Implemented with hardware coherency support.
[27:24]	FCSE	Indicates support for <i>Fast Context Switch Extension</i> (FCSE): 0x0 Not supported.
[23:20]	AuxReg	Indicates support for Auxiliary registers: 0x1 Support for Auxiliary Control Register only.
[19:16]	TCM	Indicates support for TCMs and associated DMAs: 0x0 Not supported.
[15:12]	ShareLvl	Indicates the number of shareability levels implemented: 0x1 Two levels of shareability implemented.
[11:8]	OuterShr	Indicates the outermost shareability domain implemented: 0x1 Implemented with hardware coherency support.
[7:4]	PMSA	Indicates support for a <i>Protected Memory System Architecture</i> (PMSA): 0x0 Not supported.
[3:0]	VMSA	Indicates support for a <i>Virtual Memory System Architecture</i> (VMSA). 0x5 Support for: <ul style="list-style-type: none"> VMSAv7, with support for remapping and the Access flag. The PXN bit in the Short-descriptor translation table format descriptors. The Long-descriptor translation table format.

To access the ID_MMFR0_EL1:

MRS <Xt>, ID_MMFR0_EL1 ; Read ID_MMFR0_EL1 into Xt

Register access is encoded as follows:

Table 4-26 ID_MMFR0_EL1 access encoding

op0	op1	CRn	CRm	op2
11	000	0000	0001	100

4.3.9 AArch32 Memory Model Feature Register 1

The ID_MMFR1_EL1 characteristics are:

Purpose Provides information about the memory model and memory management support in AArch32.

Usage constraints This register is accessible as follows:

EL0	EL1 (NS)	EL1 (S)	EL2	EL3 (SCR.NS = 1)	EL3 (SCR.NS = 0)
-	RO	RO	RO	RO	RO

Configurations ID_MMFR1_EL1 is architecturally mapped to AArch32 register ID_MMFR1. See *Memory Model Feature Register 1* on page 4-166.

Attributes ID_MMFR1_EL1 is a 32-bit register.

Figure 4-8 shows the ID_MMFR1_EL1 bit assignments.

31	28	27	24	23	20	19	16	15	12	11	8	7	4	3	0
BPred		L1TstCln		L1Uni		L1Hvd		L1UniSW		L1HvdSW		L1UniVA		L1HvdVA	

Figure 4-8 ID_MMFR1_EL1 bit assignments

Table 4-27 shows the ID_MMFR1_EL1 bit assignments.

Table 4-27 ID_MMFR1_EL1 bit assignments

Bits	Name	Function
[31:28]	BPred	Indicates branch predictor management requirements: 0x4 For execution correctness, branch predictor requires no flushing at any time.
[27:24]	L1TstCln	Indicates the supported L1 Data cache test and clean operations, for Harvard or unified cache implementation: 0x0 None supported.
[23:20]	L1Uni	Indicates the supported entire L1 cache maintenance operations, for a unified cache implementation: 0x0 None supported.
[19:16]	L1Hvd	Indicates the supported entire L1 cache maintenance operations, for a Harvard cache implementation: 0x0 None supported.
[15:12]	L1UniSW	Indicates the supported L1 cache line maintenance operations by set/way, for a unified cache implementation: 0x0 None supported.
[11:8]	L1HvdSW	Indicates the supported L1 cache line maintenance operations by set/way, for a Harvard cache implementation: 0x0 None supported.
[7:4]	L1UniVA	Indicates the supported L1 cache line maintenance operations by MVA, for a unified cache implementation: 0x0 None supported.
[3:0]	L1HvdVA	Indicates the supported L1 cache line maintenance operations by MVA, for a Harvard cache implementation: 0x0 None supported.

To access the ID_MMFR1_EL1:

MRS <Xt>, ID_MMFR1_EL1 ; Read ID_MMFR1_EL1 into Xt

Register access is encoded as follows:

Table 4-28 ID_MMFR1_EL1 access encoding

op0	op1	CRn	CRm	op2
11	000	0000	0001	101

4.3.10 AArch32 Memory Model Feature Register 2

The ID_MMFR2_EL1 characteristics are:

Purpose Provides information about the implemented memory model and memory management support in AArch32.

Usage constraints This register is accessible as follows:

EL0	EL1 (NS)	EL1 (S)	EL2	EL3 (SCR.NS = 1)	EL3 (SCR.NS = 0)
-	RO	RO	RO	RO	RO

Configurations ID_MMFR2_EL1 is architecturally mapped to AArch32 register ID_MMFR2. See [Memory Model Feature Register 2 on page 4-168](#).

Attributes ID_MMFR2_EL1 is a 32-bit register.

Figure 4-9 shows the ID_MMFR2_EL1 bit assignments.

31	28	27	24	23	20	19	16	15	12	11	8	7	4	3	0
HWAaccFlg		WFIStall		MemBarr		UniTLB		HvdTLB		LL1HvdRng		L1HvdBG		L1HvdFG	

Figure 4-9 ID_MMFR2_EL1 bit assignments

Table 4-29 shows the ID_MMFR2_EL1 bit assignments.

Table 4-29 ID_MMFR2_EL1 bit assignments

Bits	Name	Function
[31:28]	HWAccFlg	Hardware access flag. Indicates support for a hardware access flag, as part of the VMSAv7 implementation: 0x0 Not supported.
[27:24]	WFIStall	Wait For Interrupt Stall. Indicates the support for <i>Wait For Interrupt</i> (WFI) stalling: 0x1 Support for WFI stalling.
[23:20]	MemBarr	Memory Barrier. Indicates the supported CP15 memory barrier operations. 0x2 Supported CP15 memory barrier operations are: <ul style="list-style-type: none"> • <i>Data Synchronization Barrier</i> (DSB). • <i>Instruction Synchronization Barrier</i> (ISB). • <i>Data Memory Barrier</i> (DMB).
[19:16]	UniTLB	Unified TLB. Indicates the supported TLB maintenance operations, for a unified TLB implementation. 0x6 Supported unified TLB maintenance operations are: <ul style="list-style-type: none"> • Invalidate all entries in the TLB. • Invalidate TLB entry by MVA. • Invalidate TLB entries by ASID match. • Invalidate instruction TLB and data TLB entries by MVA All ASID. This is a shared unified TLB operation. • Invalidate Hyp mode unified TLB entry by MVA. • Invalidate entire Non-secure EL1 and EL0 unified TLB. • Invalidate entire Hyp mode unified TLB. • TLBIMVALIS, TLBIMVAALIS, TLBIMVALHIS, TLBIMVAL, TLBIMVAAL, and TLBIMVALH. • TLBIIPAS2IS, TLBIIPAS2LIS, TLBIIPAS2, and TLBIIPAS2L.
[15:12]	HvdTLB	Harvard TLB. Indicates the supported TLB maintenance operations, for a Harvard TLB implementation: 0x0 Not supported.
[11:8]	LL1HvdRng	L1 Harvard cache Range. Indicates the supported L1 cache maintenance range operations, for a Harvard cache implementation: 0x0 Not supported.
[7:4]	L1HvdBG	L1 Harvard cache Background fetch. Indicates the supported L1 cache background prefetch operations, for a Harvard cache implementation: 0x0 Not supported.
[3:0]	L1HvdFG	L1 Harvard cache Foreground fetch. Indicates the supported L1 cache foreground prefetch operations, for a Harvard cache implementation: 0x0 Not supported.

To access the ID_MMFR2_EL1:

MRS <Xt>, ID_MMFR2_EL1 ; Read ID_MMFR2_EL1 into Xt

Register access is encoded as follows:

Table 4-30 ID_MMFR2_EL1 access encoding

op0	op1	CRn	CRm	op2
11	000	0000	0001	110

4.3.11 AArch32 Memory Model Feature Register 3

The ID_MMFR3_EL1 characteristics are:

Purpose Provides information about the memory model and memory management support in AArch32.

Usage constraints This register is accessible as follows:

EL0	EL1 (NS)	EL1 (S)	EL2	EL3 (SCR.NS = 1)	EL3 (SCR.NS = 0)
-	RO	RO	RO	RO	RO

Configurations ID_MMFR3_EL1 is architecturally mapped to AArch32 register ID_MMFR3. See [Memory Model Feature Register 3 on page 4-170](#).

Attributes ID_MMFR3_EL1 is a 32-bit register.

[Figure 4-10](#) shows the ID_MMFR3_EL1 bit assignments.

31	28	27	24	23	20	19	16	15	12	11	8	7	4	3	0
Supersec		CMemSz		CohWalk		Reserved		MaintBcst		BPMaint		CMaintSW		CMaintVA	

Figure 4-10 ID_MMFR3_EL1 bit assignments

Table 4-31 shows the ID_MMFR3_EL1 bit assignments.

Table 4-31 ID_MMFR3_EL1 bit assignments

Bits	Name	Function
[31:28]	Supersec	Supersections. Indicates support for supersections: 0x0 Supersections supported.
[27:24]	CMemSz	Cached memory size. Indicates the size of physical memory supported by the processor caches: 0x2 1TByte, corresponding to a 40-bit physical address range.
[23:20]	CohWalk	Coherent walk. Indicates whether translation table updates require a clean to the point of unification: 0x1 Updates to the translation tables do not require a clean to the point of unification to ensure visibility by subsequent translation table walks.
[19:16]	-	Reserved, RES0.
[15:12]	MaintBcst	Maintenance broadcast. Indicates whether cache, TLB and branch predictor operations are broadcast: 0x2 Cache, TLB and branch predictor operations affect structures according to shareability and defined behavior of instructions.
[11:8]	BPMaint	Branch predictor maintenance. Indicates the supported branch predictor maintenance operations. 0x2 Supported branch predictor maintenance operations are: <ul style="list-style-type: none"> • Invalidate all branch predictors. • Invalidate branch predictors by MVA.
[7:4]	CMaintSW	Cache maintenance by set/way. Indicates the supported cache maintenance operations by set/way. 0x1 Supported hierarchical cache maintenance operations by set/way are: <ul style="list-style-type: none"> • Invalidate data cache by set/way. • Clean data cache by set/way. • Clean and invalidate data cache by set/way.
[3:0]	CMaintVA	Cache maintenance by MVA. Indicates the supported cache maintenance operations by MVA. 0x1 Supported hierarchical cache maintenance operations by MVA are: <ul style="list-style-type: none"> • Invalidate data cache by MVA^a. • Clean data cache by MVA. • Clean and invalidate data cache by MVA. • Invalidate instruction cache by MVA. • Invalidate all instruction cache entries.

- a. Invalidate data cache by MVA operations are treated as clean and invalidate data cache by MVA operations on the executing core. If the operation is broadcast to another core then it is broadcast as an invalidate data cache by MVA operation.

To access the ID_MMFR3_EL1:

MRS <Xt>, ID_MMFR3_EL1 ; Read ID_MMFR3_EL1 into Xt

Register access is encoded as follows:

Table 4-32 ID_MMFR3_EL1 access encoding

op0	op1	CRn	CRm	op2
11	000	0000	0001	111

4.3.12 AArch32 Instruction Set Attribute Register 0

The ID_ISAR0_EL1 characteristics are:

Purpose Provides information about the instruction sets implemented by the processor in AArch32.

Usage constraints This register is accessible as follows:

EL0	EL1 (NS)	EL1 (S)	EL2	EL3 (SCR.NS = 1)	EL3 (SCR.NS = 0)
-	RO	RO	RO	RO	RO

Configurations ID_ISAR0_EL1 is architecturally mapped to AArch32 register ID_ISAR0. See [Instruction Set Attribute Register 0 on page 4-172](#).

Attributes ID_ISAR0_EL1 is a 32-bit register.

[Figure 4-11](#) shows the ID_ISAR0_EL1 bit assignments.

31	28	27	24	23	20	19	16	15	12	11	8	7	4	3	0
RES0		Divide		Debug		Coprocc		CmpBranch		Bitfield		BitCount		Swap	

Figure 4-11 ID_ISAR0_EL1 bit assignments

[Table 4-33](#) shows the ID_ISAR0_EL1 bit assignments.

Table 4-33 ID_ISAR0_EL1 bit assignments

Bits	Name	Function
[31:28]	-	Reserved, RES0.
[27:24]	Divide	Indicates the implemented Divide instructions: 0x2 <ul style="list-style-type: none"> SDIV and UDIV in the T32 instruction set. SDIV and UDIV in the A32 instruction set.
[23:20]	Debug	Indicates the implemented Debug instructions: 0x1 BKPT.
[19:16]	Coprocc	Indicates the implemented Coprocessor instructions: 0x0 None implemented, except for separately attributed by the architecture including CP15, CP14, Advanced SIMD and Floating-point.
[15:12]	CmpBranch	Indicates the implemented combined Compare and Branch instructions in the T32 instruction set: 0x1 CBNZ and CBZ.
[11:8]	Bitfield	Indicates the implemented bit field instructions: 0x1 BFC, BFI, SBFX, and UBFX.
[7:4]	BitCount	Indicates the implemented Bit Counting instructions: 0x1 CLZ.
[3:0]	Swap	Indicates the implemented Swap instructions in the A32 instruction set: 0x0 None implemented.

To access the ID_ISAR0_EL1:

MRS <Xt>, ID_ISAR0_EL1 ; Read ID_ISAR0_EL1 into Xt

Register access is encoded as follows:

Table 4-34 ID_ISAR0_EL1 access encoding

op0	op1	CRn	CRm	op2
11	000	0000	0010	000

4.3.13 AArch32 Instruction Set Attribute Register 1

The ID_ISAR1_EL1 characteristics are:

Purpose Provides information about the instruction sets implemented by the processor in AArch32.

Usage constraints This register is accessible as follows:

EL0	EL1 (NS)	EL1 (S)	EL2	EL3 (SCR.NS = 1)	EL3 (SCR.NS = 0)
-	RO	RO	RO	RO	RO

Configurations ID_ISAR1_EL1 is architecturally mapped to AArch32 register ID_ISAR1. See *Instruction Set Attribute Register 1* on page 4-173.

Attributes ID_ISAR1_EL1 is a 32-bit register.

Figure 4-12 shows the ID_ISAR1_EL1 bit assignments.

31	28	27	24	23	20	19	16	15	12	11	8	7	4	3	0
Jazelle		Interwork		Immediate		IfThen		Extend		Except_AR		Except		Endian	

Figure 4-12 ID_ISAR1_EL1 bit assignments

Table 4-35 shows the ID_ISAR1_EL1 bit assignments.

Table 4-35 ID_ISAR1_EL1 bit assignments

Bits	Name	Function
[31:28]	Jazelle	Indicates the implemented Jazelle state instructions: 0x1 Adds the BXJ instruction, and the J bit in the PSR. This setting might indicate a trivial implementation of the Jazelle extension.
[27:24]	Interwork	Indicates the implemented Interworking instructions: 0x3 <ul style="list-style-type: none"> The BX instruction, and the T bit in the PSR. The BLX instruction. The PC loads have BX-like behavior. Data-processing instructions in the A32 instruction set with the PC as the destination and the S bit clear, have BX-like behavior.
[23:20]	Immediate	Indicates the implemented data-processing instructions with long immediates: 0x1 <ul style="list-style-type: none"> The MOVT instruction. The MOV instruction encodings with zero-extended 16-bit immediates. The T32 ADD and SUB instruction encodings with zero-extended 12-bit immediates, and other ADD, ADR, and SUB encodings cross-referenced by the pseudocode for those encodings.
[19:16]	IfThen	Indicates the implemented If-Then instructions in the T32 instruction set: 0x1 The IT instructions, and the IT bits in the PSRs.
[15:12]	Extend	Indicates the implemented Extend instructions: 0x2 <ul style="list-style-type: none"> The SXTB, SXTL, UXTB, and UXTL instructions. The SXTB16, SXTAB, SXTAB16, SXTAH, UXTB16, UXTAB, UXTAB16, and UXTAH instructions.
[11:8]	Except_AR	Indicates the implemented A profile exception-handling instructions: 0x1 The SRS and RFE instructions, and the A profile forms of the CPS instruction.
[7:4]	Except	Indicates the implemented exception-handling instructions in the A32 instruction set: 0x1 The LDM (exception return), LDM (user registers), and STM (user registers) instruction versions.
[3:0]	Endian	Indicates the implemented Endian instructions: 0x1 The SETEND instruction, and the E bit in the PSRs.

To access the ID_ISAR1_EL1:

MRS <Xt>, ID_ISAR1_EL1 ; Read ID_ISAR1_EL1 into Xt

Register access is encoded as follows:

Table 4-36 ID_ISAR1_EL1 access encoding

op0	op1	CRn	CRm	op2
11	000	0000	0010	001

4.3.14 AArch32 Instruction Set Attribute Register 2

The ID_ISAR2_EL1 characteristics are:

Purpose Provides information about the instruction sets implemented by the processor in AArch32.

Usage constraints This register is accessible as follows:

EL0	EL1 (NS)	EL1 (S)	EL2	EL3 (SCR.NS = 1)	EL3 (SCR.NS = 0)
-	RO	RO	RO	RO	RO

Configurations ID_ISAR2_EL1 is architecturally mapped to AArch32 register ID_ISAR2. See [Instruction Set Attribute Register 2 on page 4-175](#).

Attributes ID_ISAR2_EL1 is a 32-bit register.

[Figure 4-13](#) shows the ID_ISAR2_EL1 bit assignments.

31	28	27	24	23	20	19	16	15	12	11	8	7	4	3	0
Reversal	PSR_AR		MultU		MultS		Mult		MultiAccessInt			MemHint	LoadStore		

Figure 4-13 ID_ISAR2_EL1 bit assignments

Table 4-37 shows the ID_ISAR2_EL1 bit assignments.

Table 4-37 ID_ISAR2_EL1 bit assignments

Bits	Name	Function
[31:28]	Reversal	Indicates the implemented Reversal instructions: 0x2 The REV, REV16, REVSH, and RBIT instructions.
[27:24]	PSR_AR	Indicates the implemented A and R profile instructions to manipulate the PSR: 0x1 The MRS and MSR instructions, and the exception return forms of data-processing instructions.
<p style="text-align: center;">Note</p> <p>The exception return forms of the data-processing instructions are:</p> <ul style="list-style-type: none"> In the A32 instruction set, data-processing instructions with the PC as the destination and the S bit set. In the T32 instruction set, the SUBS PC, LR, #N instruction. 		
[23:20]	MultU	Indicates the implemented advanced unsigned Multiply instructions: 0x2 The UMULL, UMLAL and UMAAL instructions.
[19:16]	MultS	Indicates the implemented advanced signed Multiply instructions. 0x3 <ul style="list-style-type: none"> The SMULL and SMLAL instructions. The SMLABB, SMLABT, SMLALBB, SMLALBT, SMLALTB, SMLALTT, SMLATB, SMLATT, SMLAWB, SMLAWT, SMULBB, SMULBT, SMULTB, SMULTT, SMULWB, SMULWT instructions, and the Q bit in the PSRs. The SMLAD, SMLADX, SMLALD, SMLALDX, SMLSD, SMLSDX, SMLSLD, SMLSLDX, SMMLA, SMMLAR, SMMLS, SMMLSR, SMMUL, SMMULR, SMUAD, SMUADX, SMUSD, and SMUSDX instructions.
[15:12]	Mult	Indicates the implemented additional Multiply instructions: 0x2 The MUL, MLA and MLS instructions.
[11:8]	MultiAccessInt	Indicates the support for interruptible multi-access instructions: 0x0 No support. This means the LDM and STM instructions are not interruptible.
[7:4]	MemHint	Indicates the implemented memory hint instructions: 0x4 <ul style="list-style-type: none"> The PLD instruction. The PLI instruction. The PLDW instruction.
[3:0]	LoadStore	Indicates the implemented additional load/store instructions: 0x2 <ul style="list-style-type: none"> The LDRD and STRD instructions. The Load Acquire (LDAB, LDAH, LDA, LDAEXB, LDAEXH, LDAEX, and LDAEXD) and Store Release (STLB, STLH, STL, STLEXB, STLEXH, STLEX, and STLEXD) instructions.

To access the ID_ISAR2_EL1:

MRS <Xt>, ID_ISAR2_EL1 ; Read ID_ISAR2_EL1 into Xt

Register access is encoded as follows:

Table 4-38 ID_ISAR2_EL1 access encoding

op0	op1	CRn	CRm	op2
11	000	0000	0010	010

4.3.15 AArch32 Instruction Set Attribute Register 3

The ID_ISAR3_EL1 characteristics are:

Purpose Provides information about the instruction sets implemented by the processor in AArch32.

Usage constraints This register is accessible as follows:

EL0	EL1 (NS)	EL1 (S)	EL2	EL3 (SCR.NS = 1)	EL3 (SCR.NS = 0)
-	RO	RO	RO	RO	RO

Configurations ID_ISAR3_EL1 is architecturally mapped to AArch32 register ID_ISAR3. See [Instruction Set Attribute Register 3 on page 4-178](#).

Attributes ID_ISAR3_EL1 is a 32-bit register.

Figure 4-14 shows the ID_ISAR3_EL1 bit assignments.

31	28	27	24	23	20	19	16	15	12	11	8	7	4	3	0
ThumbEE	TrueNOP		ThumbCopy		TabBranch		SynchPrim		SVC		SIMD		Saturate		

Figure 4-14 ID_ISAR3_EL1 bit assignments

Table 4-39 shows the ID_ISAR3_EL1 bit assignments.

Table 4-39 ID_ISAR3_EL1 bit assignments

Bits	Name	Function
[31:28]	ThumbEE	Indicates the implemented Thumb Execution Environment (T32EE) instructions: 0x0 None implemented.
[27:24]	TrueNOP	Indicates support for True NOP instructions: 0x1 True NOP instructions in both the A32 and T32 instruction sets, and additional NOP-compatible hints.
[23:20]	ThumbCopy	Indicates the support for T32 non flag-setting MOV instructions: 0x1 Support for T32 instruction set encoding T1 of the MOV (register) instruction, copying from a low register to a low register.
[19:16]	TabBranch	Indicates the implemented Table Branch instructions in the T32 instruction set. 0x1 The TBB and TBH instructions.
[15:12]	SynchPrim	Indicates the implemented Synchronization Primitive instructions: 0x2 <ul style="list-style-type: none"> The LDREX and STREX instructions. The CLREX, LDREXB, STREXB, and STREXH instructions. The LDREXD and STREXD instructions.
[11:8]	SVC	Indicates the implemented SVC instructions: 0x1 The SVC instruction.
[7:4]	SIMD	Indicates the implemented <i>Single Instruction Multiple Data</i> (SIMD) instructions. 0x3 <ul style="list-style-type: none"> The SSAT and USAT instructions, and the Q bit in the PSRs. The PKHBT, PKHTB, QADD16, QADD8, QASX, QSUB16, QSUB8, QSAX, SADD16, SADD8, SASX, SEL, SHADD16, SHADD8, SHASX, SHSUB16, SHSUB8, SHSAX, SSAT16, SSUB16, SSUB8, SSAX, SXTAB16, SXTB16, UADD16, UADD8, UASX, UHADD16, UHADD8, UHASX, UHSUB16, UHSUB8, UHSAX, UQADD16, UQADD8, UQASX, UQSUB16, UQSUB8, UQSAX, USAD8, USADA8, USAT16, USUB16, USUB8, USAX, UXTAB16, UXTB16 instructions, and the GE[3:0] bits in the PSRs.
[3:0]	Saturate	Indicates the implemented Saturate instructions: 0x1 The QADD, QDADD, QDSUB, QSUB and the Q bit in the PSRs.

To access the ID_ISAR3_EL1:

MRS <Xt>, ID_ISAR3_EL1 ; Read ID_ISAR3_EL1 into Xt

Register access is encoded as follows:

Table 4-40 ID_ISAR3_EL1 access encoding

op0	op1	CRn	CRm	op2
11	000	0000	0010	011

4.3.16 AArch32 Instruction Set Attribute Register 4

The ID_ISAR4_EL1 characteristics are:

Purpose Provides information about the instruction sets implemented by the processor in AArch32.

Usage constraints This register is accessible as follows:

EL0	EL1 (NS)	EL1 (S)	EL2	EL3 (SCR.NS = 1)	EL3 (SCR.NS = 0)
-	RO	RO	RO	RO	RO

Configurations ID_ISAR4_EL1 is architecturally mapped to AArch32 register ID_ISAR4. See [Instruction Set Attribute Register 4 on page 4-179](#).

Attributes ID_ISAR4_EL1 is a 32-bit register.

Figure 4-15 shows the ID_ISAR4_EL1 bit assignments.

31	28	27	24	23	20	19	16	15	12	11	8	7	4	3	0
SWP_frac		PSR_M			Barrier			SMC		Writeback		WithShifts		Unpriv	
SynchPrim_frac —															

Figure 4-15 ID_ISAR4_EL1 bit assignments

Table 4-41 shows the ID_ISAR4_EL1 bit assignments.

Table 4-41 ID_ISAR4_EL1 bit assignments

Bits	Name	Function
[31:28]	SWP_frac	Indicates support for the memory system locking the bus for SWP or SWPB instructions: 0x0 SWP and SWPB instructions not implemented.
[27:24]	PSR_M	Indicates the implemented M profile instructions to modify the PSRs: 0x0 None implemented.
[23:20]	SynchPrim_frac	This field is used with the ID_ISAR3.SynchPrim field to indicate the implemented Synchronization Primitive instructions: 0x0 <ul style="list-style-type: none"> The LDREX and STREX instructions. The CLREX, LDREXB, LDREXH, STREXB, and STREXH instructions. The LDREXD and STREXD instructions.
[19:16]	Barrier	Indicates the supported Barrier instructions in the A32 and T32 instruction sets: 0x1 The DMB, DSB, and ISB barrier instructions.
[15:12]	SMC	Indicates the implemented SMC instructions: 0x1 The SMC instruction.
[11:8]	WriteBack	Indicates the support for Write-Back addressing modes: 0x1 Processor supports all of the Write-Back addressing modes defined in ARMv8.
[7:4]	WithShifts	Indicates the support for instructions with shifts. 0x4 <ul style="list-style-type: none"> Support for shifts of loads and stores over the range LSL 0-3. Support for other constant shift options, both on load/store and other instructions. Support for register-controlled shift options.
[3:0]	Unpriv	Indicates the implemented unprivileged instructions. 0x2 <ul style="list-style-type: none"> The LDRBT, LDRT, STRBT, and STRT instructions. The LDRHT, LDRSBT, LDRSHT, and STRHT instructions.

To access the ID_ISAR4_EL1:

MRS <Xt>, ID_ISAR4_EL1 ; Read ID_ISAR4_EL1 into Xt

Register access is encoded as follows:

Table 4-42 ID_ISAR4_EL1 access encoding

op0	op1	CRn	CRm	op2
11	000	0000	0010	100

4.3.17 AArch32 Instruction Set Attribute Register 5

The ID_ISAR5_EL1 characteristics are:

Purpose Provides information about the instruction sets that the processor implements.

———— **Note** —————

The optional Advanced SIMD and Floating-point extension is not included in the base product of the processor. ARM requires licensees to have contractual rights to obtain the Advanced SIMD and Floating-point extension.

Usage constraints This register is accessible as follows:

EL0	EL1 (NS)	EL1 (S)	EL2	EL3 (SCR.NS = 1)	EL3 (SCR.NS = 0)
-	RO	RO	RO	RO	RO

Configurations ID_ISAR5_EL1 is architecturally mapped to AArch32 register ID_ISAR5. See [Instruction Set Attribute Register 5](#) on page 4-181.

Attributes ID_ISAR5_EL1 is a 32-bit register.

[Figure 4-16](#) shows the ID_ISAR5_EL1 bit assignments.

31	20	19	16	15	12	11	8	7	4	3	0
RES0			CRC32		SHA2		SHA1		AES		SEVL

Figure 4-16 ID_ISAR5_EL1 bit assignments

Table 4-43 shows the ID_ISAR5_EL1 bit assignments.

Table 4-43 ID_ISAR5_EL1 bit assignments

Bits	Name	Function
[31:20]	-	Reserved, RES0.
[19:16]	CRC32	Indicates whether CRC32 instructions are implemented in AArch32 state: 0x1 CRC32 instructions are implemented.
[15:12]	SHA2	Indicates whether SHA2 instructions are implemented in AArch32 state: 0x0 Cryptography Extensions are not implemented or are disabled. 0x1 SHA256H, SHA256H2, SHA256SU0, and SHA256SU1 instructions are implemented.
[11:8]	SHA1	Indicates whether SHA1 instructions are implemented in AArch32 state: 0x0 Cryptography Extensions are not implemented or are disabled. 0x1 SHA1C, SHA1P, SHA1M, SHA1H, SHA1SU0, and SHA1SU1 instructions are implemented.
[7:4]	AES	Indicates whether AES instructions are implemented in AArch32 state: 0x0 Cryptography Extensions are not implemented or are disabled. 0x2 AESE, AESD, AESMC and AESIMC, plus PMULL and PMULL2 instructions operating on 64-bit data.
[3:0]	SEVL	Indicates whether the SEVL instruction is implemented: 0x1 SEVL implemented to send event local.

To access the ID_ISAR5_EL1:

MRS <Xt>, ID_ISAR5_EL1 ; Read ID_ISAR5_EL1 into Xt

Register access is encoded as follows:

Table 4-44 ID_ISAR5_EL1 access encoding

op0	op1	CRn	CRm	op2
11	000	0000	0010	101

4.3.18 AArch64 Processor Feature Register 0

The ID_AA64PFR0_EL1 characteristics are:

Purpose Provides additional information about implemented processor features in AArch64.

Note

The optional Advanced SIMD and Floating-point extension is not included in the base product of the processor. ARM requires licensees to have contractual rights to obtain the Advanced SIMD and Floating-point extension.

Usage constraints This register is accessible as follows:

EL0	EL1 (NS)	EL1 (S)	EL2	EL3 (SCR.NS = 1)	EL3 (SCR.NS = 0)
-	RO	RO	RO	RO	RO

Configurations ID_AA64PFR0_EL1 is architecturally mapped to external register ID_AA64PFR0_EL1.

Attributes ID_AA64PFR0_EL1 is a 64-bit register.

Figure 4-17 shows the ID_AA64PFR0_EL1 bit assignments.

63	28	27	24	23	20	19	16	15	12	11	8	7	4	3	0
RES0		GIC		FP		AdvSIMD		EL3 handling		EL2 handling		EL1 handling		EL0 handling	

Figure 4-17 ID_AA64PFR0_EL1 bit assignments

Table 4-45 shows the ID_AA64PFR0_EL1 bit assignments.

Table 4-45 ID_AA64PFR0_EL1 bit assignments

Bits	Name	Function
[63:28]	-	Reserved, RES0.
[27:24]	GIC	GIC CPU interface: 0x0 GIC CPU interface is disabled. 0x1 GIC CPU interface is implemented.
[23:20]	FP ^a	Floating-point. The possible values are: 0x0 Floating-point is implemented. 0xF Floating-point is not implemented.
[19:16]	AdvSIMD ^a	Advanced SIMD. The possible values are: 0x0 Advanced SIMD is implemented. 0xF Advanced SIMD is not implemented.
[15:12]	EL3 handling	EL3 exception handling: 0x2 Instructions can be executed at EL3 in AArch64 or AArch32 state.
[11:8]	EL2 handling	EL2 exception handling: 0x2 Instructions can be executed at EL2 in AArch64 or AArch32 state.
[7:4]	EL1 handling	EL1 exception handling. The possible values are: 0x2 Instructions can be executed at EL1 in AArch64 or AArch32 state.
[3:0]	EL0 handling	EL0 exception handling. The possible values are: 0x2 Instructions can be executed at EL0 in AArch64 or AArch32 state.

a. The FP and AdvSIMD both take the same value, as both must be implemented, or neither.

To access the ID_AA64PFR0_EL1:

MRS <Xt>, ID_AA64PFR0_EL1 ; Read ID_AA64PFR0_EL1 into Xt

Register access is encoded as follows:

Table 4-46 ID_AA64PFR0_EL1 access encoding

op0	op1	CRn	CRm	op2
11	000	0000	0100	000

4.3.19 AArch64 Debug Feature Register 0, EL1

The ID_AA64DFR0_EL1 characteristics are:

Purpose Provides top level information of the debug system in the AArch64 Execution state.

Usage constraints This register is accessible as follows:

EL0	EL1 (NS)	EL1 (S)	EL2	EL3 (SCR.NS = 1)	EL3 (SCR.NS = 0)
-	RO	RO	RO	RO	RO

Configurations ID_AA64DFR0_EL1 is architecturally mapped to external register ID_AA64DFR0.

Attributes ID_AA64DFR0_EL1 is a 64-bit register.

Figure 4-18 shows the ID_AA64DFR0_EL1 bit assignments.

63	32	31	28	27	24	23	20	19	16	15	12	11	8	7	4	3	0
RES0		CTX_CMPs		RES0		WRPs		RES0		BRPs		PMUver		Tracever		Debugger	

Figure 4-18 ID_AA64DFR0_EL1 bit assignments

Table 4-47 shows the ID_AA64DFR0_EL1 bit assignments.

Table 4-47 ID_AA64DFR0_EL1 bit assignments

Bits	Name	Function
[63:32]	-	Reserved, RES0.
[31:28]	CTX_CMPs	Number of breakpoints that are context-aware, minus 1. These are the highest numbered breakpoints: 0b0001 Two breakpoints are context-aware.
[27:24]	-	Reserved, RES0.
[23:20]	WRPs	The number of watchpoints minus 1: 0b0003 Four watchpoints.
[19:16]	-	Reserved, RES0.
[15:12]	BRPs	The number of breakpoints minus 1: 0b0005 Six breakpoints.
[11:8]	PMUver	Performance Monitors extension version. 0b0001 Performance monitor system registers implemented, PMUv3.
[7:4]	Tracever	Trace extension: 0b0000 Trace system registers not implemented.
[3:0]	Debugger	Debug architecture version: 0b0110 ARMv8-A debug architecture implemented.

To access the ID_AA64DFR0_EL1:

Table 4-49 shows the ID_AA64ISAR0_EL1 bit assignments.

Table 4-49 ID_AA64ISAR0_EL1 bit assignments

Bits	Name	Function
[63:20]	-	Reserved, RES0.
[19:16]	CRC32	0x1 CRC32 instructions are implemented.
[15:12]	SHA2	Indicates whether SHA2 instructions are implemented. The possible values are: 0b0000 No SHA2 instructions implemented. This is the value if the implementation does not include the Cryptography Extension, or if it is disabled. 0b0001 SHA256H, SHA256H2, SHA256U0, and SHA256U1 implemented. This is the value if the implementation includes the Cryptography Extension. All other values reserved.
[11:8]	SHA1	Indicates whether SHA1 instructions are implemented. The possible values are: 0b0000 No SHA1 instructions implemented. This is the value if the implementation does not include the Cryptography Extension. 0b0001 SHA1C, SHA1P, SHA1M, SHA1SU0, and SHA1SU1 implemented. This is the value if the implementation includes the Cryptography Extension. All other values reserved.
[7:4]	AES	Indicates whether AES instructions are implemented. The possible values are: 0b0000 No AES instructions implemented. This is the value if the implementation does not include the Cryptography Extension. 0b0010 AESE, AESD, AESMC, and AESIMC implemented, plus PMULL and PMULL2 instructions operating on 64-bit data. This is the value if the implementation includes the Cryptography Extension. All other values reserved.
[3:0]	-	Reserved, RES0.

To access the ID_AA64ISAR0_EL1:

MRS <Xt>, ID_AA64ISAR0_EL1 ; Read ID_AA64ISAR0_EL1 into Xt

Register access is encoded as follows:

Table 4-50 ID_AA64ISAR0_EL1 access encoding

op0	op1	CRn	CRm	op2
11	000	0000	0110	000

4.3.21 AArch64 Memory Model Feature Register 0, EL1

The ID_AA64MMFR0_EL1 characteristics are:

Purpose Provides information about the implemented memory model and memory management support in the AArch64 Execution state.

Usage constraints This register is accessible as follows:

EL0	EL1 (NS)	EL1 (S)	EL2	EL3 (SCR.NS = 1)	EL3 (SCR.NS = 0)
-	RO	RO	RO	RO	RO

Configurations ID_AA64MMFR0_EL1 is architecturally mapped to external register ID_AA64MMFR0_EL1.

Attributes ID_AA64MMFR0_EL1 is a 64-bit register.

Figure 4-20 shows the ID_AA64MMFR0_EL1 bit assignments.

63	32	31	28	27	24	23	20	19	16	15	12	11	8	7	4	3	0
RES0		TGran4	TGran64	TGran16	BigEndEL0	SNSMem	BigEnd	ASIDBits	PARange								

Figure 4-20 ID_AA64MMFR0_EL1 bit assignments

Table 4-51 shows the ID_AA64MMFR0_EL1 bit assignments.

Table 4-51 ID_AA64MMFR0_EL1 bit assignments

Bits	Name	Function
[63:32]	-	Reserved, RES0.
[31:28]	TGran4	Support for 4 KB memory translation granule size: 0x0 Indicates that the 4KB granule is supported.
[27:24]	TGran64	Support for 64 KB memory translation granule size: 0x0 Indicates that the 64KB granule is supported.
[23:20]	TGran16	Support for 16 KB memory translation granule size: 0x0 Indicates that the 16KB granule is not supported.
[19:16]	BigEndEL0	Mixed-endian support only at EL0. RES0
[15:12]	SNSMem	Secure versus Non-secure Memory distinction: 0b0001 Supports a distinction between Secure and Non-secure Memory.
[11:8]	BigEnd	Mixed-endian configuration support: 0b0001 Mixed-endian support. The SCTL _R _EL _x .EE and SCTL _R _EL ₁ .E0E bits are RW.
[7:4]	ASIDBits	Number of ASID bits: 0b0010 16 bits.
[3:0]	PARange	Physical address range supported: 0b0010 40 bits, 1 TB.

To access the ID_AA64MMFR0_EL1:

MRS <Xt>, ID_AA64MMFR0_EL1 ; Read ID_AA64MMFR0_EL1 into Xt

Register access is encoded as follows:

Table 4-52 ID_AA64MMFR0_EL1 access encoding

op0	op1	CRn	CRm	op2
11	000	0000	0111	000

4.3.22 Cache Size ID Register

The CCSIDR_EL1 characteristics are:

Purpose Provides information about the architecture of the caches.

Usage constraints This register is accessible as follows:

EL0	EL1 (NS)	EL1 (S)	EL2	EL3 (SCR.NS = 1)	EL3 (SCR.NS = 0)
-	RO	RO	RO	RO	RO

Configurations CCSIDR_EL1 is architecturally mapped to AArch32 register CCSIDR. See [Cache Size ID Register on page 4-183](#).

Attributes CCSIDR_EL1 is a 32-bit register.

Figure 4-21 shows the CCSIDR_EL1 bit assignments.

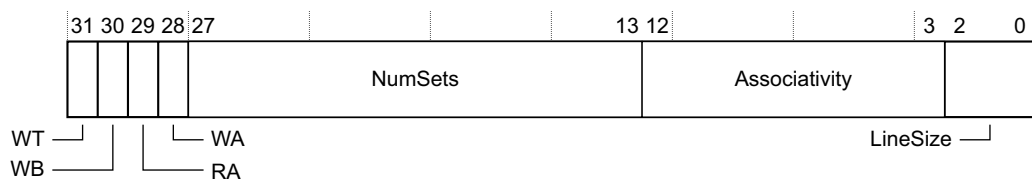

Figure 4-21 CCSIDR_EL1 bit assignments

Table 4-53 shows the CCSIDR_EL1 bit assignments.

Table 4-53 CCSIDR_EL1 bit assignments

Bits	Name	Function
[31]	WT	Indicates support for write-through: 0 Cache level does not support write-through.
[30]	WB	Indicates support for write-back: 0 Cache level does not support write-back. 1 Cache level supports write-back.
[29]	RA	Indicates support for Read-Allocation: 0 Cache level does not support Read-Allocation. 1 Cache level supports Read-Allocation.
[28]	WA	Indicates support for Write-Allocation: 0 Cache level does not support Write-Allocation. 1 Cache level supports Write-Allocation.
[27:13]	NumSets ^a	Indicates the number of sets in cache - 1. Therefore, a value of 0 indicates 1 set in the cache. The number of sets does not have to be a power of 2.
[12:3]	Associativity ^a	Indicates the associativity of cache - 1. Therefore, a value of 0 indicates an associativity of 1. The associativity does not have to be a power of 2.
[2:0]	LineSize ^a	Indicates the (\log_2 (number of words in cache line)) - 2: 0b010 16 words per line.

a. For more information about encoding, see [Table 4-181 on page 4-185](#).

Table 4-181 on page 4-185 shows the individual bit field and complete register encodings for the CCSIDR_EL1. The CSSELR determines which CCSIDR_EL1 to select.

To access the CCSIDR_EL1:

MRS <Xt>, CCSIDR_EL1 ; Read CCSIDR_EL1 into Xt

Register access is encoded as follows:

Table 4-54 CCSIDR_EL1 access encoding

op0	op1	CRn	CRm	op2
11	001	0000	0000	000

4.3.23 Cache Level ID Register

The CLIDR_EL1 characteristics are:

Purpose

Identifies:

- The type of cache, or caches, implemented at each level.
- The Level of Coherency and Level of Unification for the cache hierarchy.

Usage constraints

This register is accessible as follows:

EL0	EL1 (NS)	EL1 (S)	EL2	EL3 (SCR.NS = 1)	EL3 (SCR.NS = 0)
-	RO	RO	RO	RO	RO

Configurations

CLIDR_EL1 is architecturally mapped to AArch32 register CLIDR. See [Cache Level ID Register on page 4-185](#).

Attributes

CLIDR_EL1 is a 32-bit register.

Figure 4-22 shows the CLIDR_EL1 bit assignments.

31	30	29	27	26	24	23	21	20				9	8	6	5	3	2	0
RES0	LoUU	LoC	LoUIS									RES0		Ctype3	Ctype2	Ctype1		

Figure 4-22 CLIDR_EL1 bit assignments

Table 4-55 shows the CLIDR_EL1 bit assignments.

Table 4-55 CLIDR_EL1 bit assignments

Bits	Name	Function
[31:30]	-	Reserved, RES0.
[29:27]	LoUU	Indicates the Level of Unification Uniprocessor for the cache hierarchy: 0b001 L1 cache is the last level of cache that must be cleaned or invalidated when cleaning or invalidating to the point of unification for the processor.
[26:24]	LoC	Indicates the Level of Coherency for the cache hierarchy: 0b001 L2 cache not implemented. A clean to the point of coherency operation requires the L1 cache to be cleaned. 0b010 L2 cache implemented. A clean to the point of coherency operation requires the L1 and L2 caches to be cleaned.
[23:21]	LoUIS	Indicates the Level of Unification Inner Shareable for the cache hierarchy: 0b001 L2 cache. L2 cache is the last level of cache that must be cleaned or invalidated when cleaning or invalidating to the point of unification for the Inner Shareable shareability domain.
[20:9]	-	Reserved, RES0.
[8:6]	Ctype3 ^a	Indicates the type of cache if the processor implements L3 cache: 0b000 L3 cache not implemented.
[5:3]	Ctype2	Indicates the type of cache if the processor implements L2 cache: 0b000 L2 cache not implemented. 0b100 Unified instruction and data caches at L2.
[2:0]	Ctype1	Indicates the type of cache implemented at L1: 0b011 Separate instruction and data caches at L1.

- a. If software reads the Cache Type fields from Ctype1 upwards, after it has seen a value of 0b000, no caches exist at further-out levels of the hierarchy. So, for example, if Ctype2 is the first Cache Type field with a value of 0b000, the value of Ctype3 must be ignored.

To access the CLIDR_EL1:

MRS <Xt>, CLIDR_EL1 ; Read CLIDR_EL1 into Xt

Register access is encoded as follows:

Table 4-56 CLIDR_EL1 access encoding

op0	op1	CRn	CRm	op2
11	001	0000	0000	001

4.3.24 Auxiliary ID Register

The processor does not implement AIDR_EL1, so this register is always RES0.

4.3.25 Cache Size Selection Register

The CSSELR_EL1 characteristics are:

- Purpose** Selects the current *Cache Size ID Register on page 4-183*, by specifying:
- The required cache level.

- The cache type, either instruction or data cache.

Usage constraints This register is accessible as follows:

EL0	EL1 (NS)	EL1 (S)	EL2	EL3 (SCR.NS = 1)	EL3 (SCR.NS = 0)
-	RW	RW	RW	RW	RW

Configurations CSSELR_EL1 is architecturally mapped to AArch32 register CSSELR(NS). See [Cache Size Selection Register](#) on page 4-187.

Attributes CSSELR_EL1 is a 32-bit register.

Figure 4-23 shows the CSSELR_EL1 bit assignments.

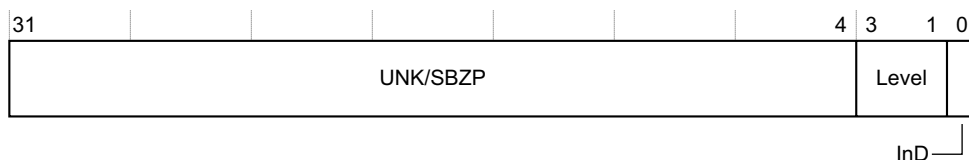

Figure 4-23 CSSELR_EL1 bit assignments

Table 4-57 shows the CSSELR_EL1 bit assignments.

Table 4-57 CSSELR_EL1 bit assignments

Bits	Name	Function
[31:4]	-	Reserved, RES0
[3:1]	Level ^a	Cache level of required cache: 0b000 L1. 0b001 L2. 0b010-0b111 Reserved.
[0]	InD ^a	Instruction not Data bit: 0 Data or unified cache. 1 Instruction cache.

a. The combination of Level=0b001 and InD=1 is reserved.

To access the CSSELR_EL1:

MRS <Xt>, CSSELR_EL1 ; Read CSSELR_EL1 into Xt
MSR CSSELR_EL1, <Xt> ; Write Xt to CSSELR_EL1

Register access is encoded as follows:

Table 4-58 CSSELR_EL1 access encoding

op0	op1	CRn	CRm	op2
11	010	0000	0001	000

4.3.26 Cache Type Register

The CTR_EL0 characteristics are:

Purpose Provides information about the architecture of the caches.

Usage constraints This register is accessible as follows:

EL0	EL1 (NS)	EL1 (S)	EL2	EL3 (SCR.NS = 1)	EL3 (SCR.NS = 0)
Config	RO	RO	RO	RO	RO

This register is accessible at EL0 when SCTLR_EL1.UCT is set to 1.

Configurations CTR_EL0 is architecturally mapped to AArch32 register CTR. See [Cache Type Register](#) on page 4-188.

Attributes CTR_EL0 is a 32-bit register.

Figure 4-24 shows the CTR_EL0 bit assignments.

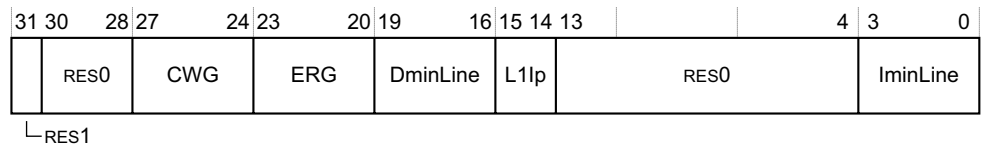

Figure 4-24 CTR_EL0 bit assignments

Table 4-59 shows the CTR_EL0 bit assignments.

Table 4-59 CTR_EL0 bit assignments

Bits	Name	Function
[31]	-	Reserved, RES1.
[30:28]	-	Reserved, RES0.
[27:24]	CWG	Cache Write-Back granule. Log ₂ of the number of words of the maximum size of memory that can be overwritten as a result of the eviction of a cache entry that has had a memory location in it modified: 0x4 Cache Write-Back granule size is 16 words.
[23:20]	ERG	Exclusives Reservation Granule. Log ₂ of the number of words of the maximum size of the reservation granule that has been implemented for the Load-Exclusive and Store-Exclusive instructions: 0x4 Exclusive reservation granule size is 16 words.
[19:16]	DminLine	Log ₂ of the number of words in the smallest cache line of all the data and unified caches that the processor controls: 0x4 Smallest data cache line size is 16 words.
[15:14]	L1Ip	L1 Instruction cache policy. Indicates the indexing and tagging policy for the L1 Instruction cache: 0b10 <i>Virtually Indexed Physically Tagged (VIPT)</i> .
[13:4]	-	Reserved, RES0.
[3:0]	IminLine	Log ₂ of the number of words in the smallest cache line of all the instruction caches that the processor controls. 0x4 Smallest instruction cache line size is 16 words.

To access the CTR_EL0:

MRS <Xt>, CTR_EL0 ; Read CTR_EL0 into Xt

Register access is encoded as follows:

Table 4-60 CTR_EL0 access encoding

op0	op1	CRn	CRm	op2
11	011	0000	0000	001

4.3.27 Data Cache Zero ID Register

The DCZID_EL0 characteristics are:

Purpose Indicates the block size written with byte values of zero by the DC ZVA (Cache Zero by Address), system instruction.

Usage constraints This register is accessible as follows:

EL0	EL1 (NS)	EL1 (S)	EL2	EL3 (SCR.NS = 1)	EL3 (SCR.NS = 0)
RO	RO	RO	RO	RO	RO

Configurations There are no configuration notes.

Attributes DCZID_EL0 is a 32-bit register.

Figure 4-25 shows the DCZID_EL0 bit assignments.

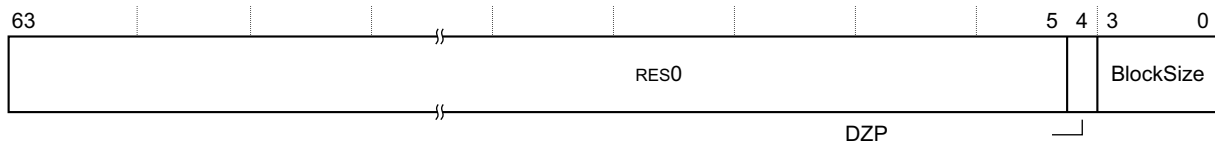

Figure 4-25 DCZID_EL0 bit assignments

Table 4-61 shows the DCZID_EL0 bit assignments.

Table 4-61 DCZID_EL0 bit assignments

Bits	Name	Function
[63:5]	-	Reserved, RES0.
[4]	DZP	Prohibit the DC ZVA instruction: 0 DC ZVA instruction permitted. 1 DC ZVA instruction is prohibited.
[3:0]	BlockSize	Log2 of the block size in words: 0b0100 The block size is 16 words.

To access the DCZID_EL0:

MRS <Xt>, DCZID_EL0 ; Read DCZID_EL0 into Xt

Register access is encoded as follows:

Table 4-62 DCZID_EL0 access encoding

op0	op1	CRn	CRm	op2
11	011	0000	0000	111

4.3.28 Virtualization Processor ID Register

The VPIDR_EL2 characteristics are:

Purpose Holds the value of the Virtualization Processor ID. This is the value returned by Non-secure EL1 reads of MIDR. See [MIDR_EL1 bit assignments on page 4-14](#).

Usage constraints This register is accessible as follows:

EL0	EL1 (NS)	EL1 (S)	EL2	EL3 (SCR.NS = 1)	EL3 (SCR.NS = 0)
-	-	-	RW	RW	-

Configurations VPIDR_EL2 is architecturally mapped to AArch32 register VPIDR. See [Virtualization Processor ID Register on page 4-189](#).

Attributes VPIDR_EL2 is a 32-bit register.
VPIDR_EL2 resets to the value of MIDR_EL1.

[Figure 4-26](#) shows the VPIDR_EL2 bit assignments.

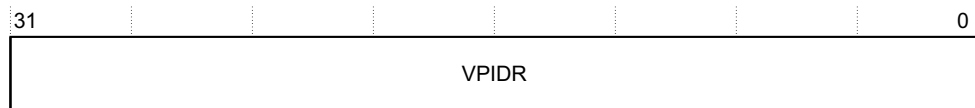

Figure 4-26 VPIDR_EL2 bit assignments

[Table 4-63](#) shows the VPIDR_EL2 bit assignments.

Table 4-63 VPIDR_EL2 bit assignments

Bits	Name	Function
[31:0]	VPIDR	MIDR value returned by Non-secure PL1 reads of the MIDR. The MIDR description defines the subdivision of this value. See MIDR_EL1 bit assignments on page 4-14 .

To access the VPIDR_EL2:

MRS <Xt>, VPIDR_EL2 ; Read VPIDR_EL2 into Xt
MSR VPIDR_EL2, <Xt> ; Write Xt to VPIDR_EL2

Register access is encoded as follows:

Table 4-64 VPIDR_EL2 access encoding

op0	op1	CRn	CRm	op2
11	100	0000	0000	000

4.3.29 Virtualization Multiprocessor ID Register

The VMPIDR_EL2 characteristics are:

Purpose Provides the value of the Virtualization Multiprocessor ID. This is the value returned by Non-secure EL1 reads of MPIDR.

Usage constraints This register is accessible as follows:

EL0	EL1 (NS)	EL1 (S)	EL2	EL3 (SCR.NS = 1)	EL3 (SCR.NS = 0)
-	-	-	RW	RW	-

Configurations VMPIDR_EL2[31:0] is architecturally mapped to AArch32 register VMPIDR. See [Virtualization Multiprocessor ID Register on page 4-190](#).

Attributes VMPIDR_EL2 is a 64-bit register.
VMPIDR_EL2 resets to the value of MPIDR_EL2.

Figure 4-27 shows the VMPIDR_EL2 bit assignments.

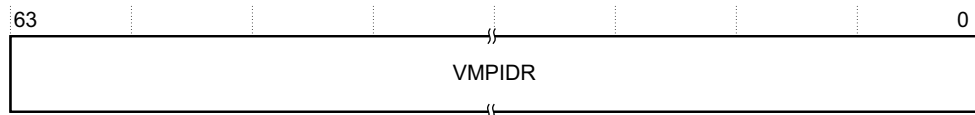

Figure 4-27 VMPIDR_EL2 bit assignments

Table 4-65 shows the VMPIDR_EL2 bit assignments.

Table 4-65 VMPIDR_EL2 bit assignments

Bits	Name	Function
[63:0]	VMPIDR	MPIDR value returned by Non-secure EL1 reads of the MPIDR_EL1. The MPIDR description defines the subdivision of this value. See MPIDR_EL1 bit assignments on page 4-16 .

To access the VMPIDR_EL2:

MRS <Xt>, VMPIDR_EL2 ; Read VMPIDR_EL2 into Xt
MSR VMPIDR_EL2, <Xt> ; Write Xt to VMPIDR_EL2

Register access is encoded as follows:

Table 4-66 VMPIDR_EL2 access encoding

op0	op1	CRn	CRm	op2
11	100	0000	0000	101

4.3.30 System Control Register, EL1

The SCTL_EL1 characteristics are:

Purpose Provides top level control of the system, including its memory system at EL1.

SCTL_EL1 is part of the Virtual memory control registers functional group.

Usage constraints This register is accessible as follows:

EL0	EL1 (NS)	EL1 (S)	EL2	EL3 (SCR.NS = 1)	EL3 (SCR.NS = 0)
-	RW	RW	RW	RW	RW

Configurations SCTLR_EL1 is architecturally mapped to AArch32 register SCTLR(NS). See [System Control Register on page 4-191](#).

Attributes SCTLR_EL1 is a 32-bit register.

Figure 4-28 shows the SCTLR_EL1 bit assignments.

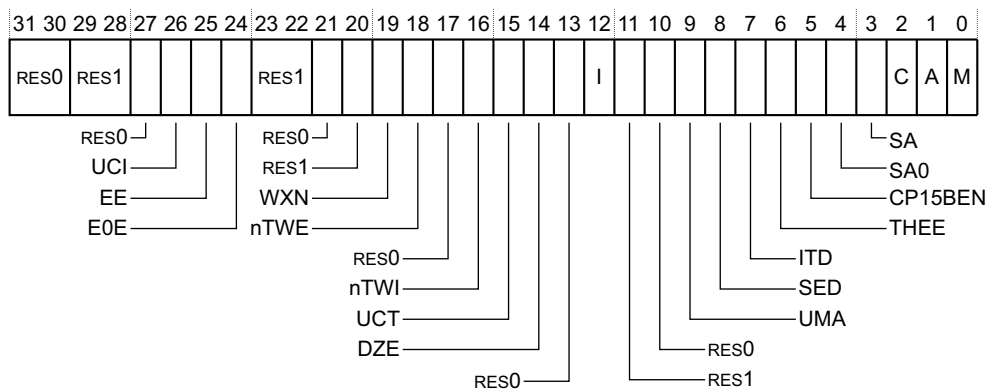

Figure 4-28 SCTLR_EL1 bit assignments

Table 4-67 shows the SCTLR_EL1 bit assignments.

Table 4-67 SCTLR_EL1 bit assignments

Bits	Name	Function
[31:30]	-	Reserved, RES0.
[29:28]	-	Reserved, RES1.
[27]	-	Reserved, RES0.
[26]	UCI	Enables EL0 access to the DC CVAU, DC CIVAC, DC CVAC and IC IVAU instructions in the AArch64 Execution state. The possible values are: 0 EL0 access disabled. This is the reset value. 1 EL0 access enabled.
[25]	EE	Exception endianness. The value of this bit controls the endianness for explicit data accesses at EL1. This value also indicates the endianness of the translation table data for translation table lookups. The possible values of this bit are: 0 Little-endian. 1 Big-endian. The reset value of this bit is determined by the CFGEND configuration pin.
[24]	E0E	Endianness of explicit data access at EL0. The possible values are: 0 Explicit data accesses at EL0 are little-endian. This is reset value. 1 Explicit data accesses at EL0 are big-endian.
[23:22]	-	Reserved, RES1.
[21]	-	Reserved, RES0.
[20]	-	Reserved, RES1.
[19]	WXN	Write permission implies <i>Execute Never</i> (XN). This bit can be used to require all memory regions with write permissions to be treated as XN. The possible values are: 0 Regions with write permission are not forced XN. This is the reset value. 1 Regions with write permissions are forced XN.
[18]	nTWE	WFE non-trapping. The possible values are: 0 A WFE instruction executed at EL0, that, if this bit was set to 1, would permit entry to a low-power state, is trapped to EL1. 1 WFE instructions executed as normal. This is the reset value.
[17]	-	Reserved, RES0.
[16]	nTWI	WFI non-trapping. The possible values are: 0 A WFI instruction executed at EL0, that, if this bit was set to 1, would permit entry to a low-power state, is trapped to EL1. 1 WFI instructions executed as normal. This is the reset value.
[15]	UCT	Enables EL0 access to the CTR_EL0 register in AArch64 Execution state. The possible values are: 0 Disables EL0 access to the CTR_EL0 register. This is the reset value. 1 Enables EL0 access to the CTR_EL0 register.
[14]	DZE	Enables access to the DC ZVA instruction at EL0. The possible values are: 0 Disables execution access to the DC ZVA instruction at EL0. The instruction is trapped to EL1. This is the reset value. 1 Enables execution access to the DC ZVA instruction at EL0.
[13]	-	Reserved, RES0.

Table 4-67 SCTLR_EL1 bit assignments (continued)

Bits	Name	Function
[12]	I	Instruction cache enable. The possible values are: 0 Instruction caches disabled. This is the reset value. 1 Instruction caches enabled.
[11]	-	Reserved, RES1.
[10]	-	Reserved, RES0.

Table 4-67 SCTLR_EL1 bit assignments (continued)

Bits	Name	Function
[9]	UMA	User Mask Access. Controls access to interrupt masks from EL0, when EL0 is using AArch64. The possible values of this bit are: 0 Disable access to the interrupt masks from EL0. 1 Enable access to the interrupt masks from EL0.
[8]	SED	SETEND instruction disable. The possible values are: 0 The SETEND instruction is enabled. This is the reset value. 1 The SETEND instruction is UNDEFINED.
[7]	ITD	IT instruction disable. The possible values are: 0 The IT instruction functionality is enabled. This is the reset value. 1 All encodings of the IT instruction with hw1[3:0]!=1000 are UNDEFINED and treated as unallocated. All encodings of the subsequent instruction with the following values for hw1 are UNDEFINED (and treated as unallocated): 11xxxxxxxxxxxx All 32-bit instructions, B(2), B(1), Undefined, SVC, Load/Store multiple 1x11xxxxxxxxxxxx Miscellaneous 16-bit instructions 1x100xxxxxxxxxxxx ADD Rd, PC, #imm 01001xxxxxxxxxxxx LDR Rd, [PC, #imm] 0100x1xxx1111xxx ADD(4),CMP(3), MOV, BX pc, BLX pc 010001xx1xxx111 ADD(4),CMP(3), MOV Contrary to the standard treatment of conditional UNDEFINED instructions in the ARM architecture, in this case these instructions are always treated as UNDEFINED, regardless of whether the instruction would pass or fail its condition codes as a result of being in an IT block.
[6]	THEE	RES0 T32EE is not implemented.
[5]	CP15BEN	CP15 barrier enable. The possible values are: 0 CP15 barrier operations disabled. Their encodings are UNDEFINED. 1 CP15 barrier operations enabled. This is the reset value.
[4]	SA0	Enable EL0 stack alignment check. The possible values are: 0 Disable EL0 stack alignment check. 1 Enable EL0 stack alignment check. This is the reset value.
[3]	SA	Enable SP alignment check. The possible values are: 0 Disable SP alignment check. 1 Enable SP alignment check. This is the reset value.
[2]	C	Cache enable. The possible values are: 0 Data and unified caches disabled. This is the reset value. 1 Data and unified caches enabled.
[1]	A	Alignment check enable. The possible values are: 0 Alignment fault checking disabled. This is the reset value. 1 Alignment fault checking enabled.

Table 4-67 SCTLR_EL1 bit assignments (continued)

Bits	Name	Function
[0]	M	MMU enable. The possible values are: 0 EL1 and EL0 stage 1 MMU disabled. This is the reset value. 1 EL1 and EL0 stage 1 MMU enabled.

To access the SCTLR_EL1:

MRS <Xt>, SCTLR_EL1 ; Read SCTLR_EL1 into Xt
 MSR SCTLR_EL1, <Xt> ; Write Xt to SCTLR_EL1

4.3.31 Auxiliary Control Register, EL1

The processor does not implement the ACTLR_EL1 register. This register is always RES0.

4.3.32 Auxiliary Control Register, EL2

The ACTLR_EL2 characteristics are:

Purpose Controls write access to IMPLEMENTATION DEFINED registers in Non-secure EL1 modes, such as CPUACTLR, CPUECTLR, L2CTLR, L2ECTLR and L2ACTLR.

Usage constraints This register is accessible as follows:

EL0	EL1 (NS)	EL1 (S)	EL2	EL3 (SCR.NS = 1)	EL3 (SCR.NS = 0)
-	-	-	RW	RW	RW

Configurations The ACTLR_EL2 is architecturally mapped to the AArch32 HACTLR register. See *Hyp Auxiliary Control Register* on page 4-205.

Attributes ACTLR_EL2 is a 32-bit register.

Figure 4-29 shows the ACTLR_EL2 bit assignments.

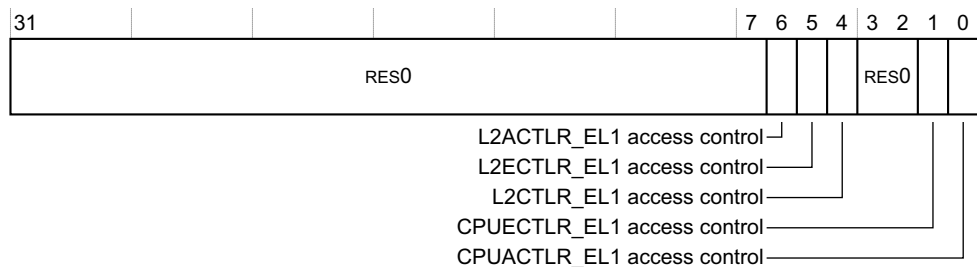

Figure 4-29 ACTLR_EL2 bit assignments

Table 4-68 shows the ACTLR_EL2 bit assignments.

Table 4-68 ACTLR_EL2 bit assignments

Bits	Name	Function
[31:7]	-	Reserved, RES0.
[6]	L2ACTLR access control	L2ACTLR_EL1 write access control. The possible values are: 0 The register is not write accessible from Non-secure EL1. This is the reset value. 1 The register is write accessible from Non-secure EL1. Write access from Non-secure EL1 also requires ACTLR_EL3[6] to be set.
[5]	L2ECTLR access control	L2ECTLR_EL1 write access control. The possible values are: 0 The register is not write accessible from Non-secure EL1. This is the reset value. 1 The register is write accessible from Non-secure EL1. Write access from Non-secure EL1 also requires ACTLR_EL3[5] to be set.
[4]	L2CTLR access control	L2CTLR_EL1 write access control. The possible values are: 0 The register is not write accessible from Non-secure EL1. This is the reset value. 1 The register is write accessible from Non-secure EL1. Write access from Non-secure EL1 also requires ACTLR_EL3[4] to be set.
[3:2]	-	Reserved, RES0.
[1]	CPUECTLR access control	CPUECTLR_EL1 write access control. The possible values are: 0 The register is not write accessible from Non-secure EL1. This is the reset value. 1 The register is write accessible from Non-secure EL1. Write access from Non-secure EL1 also requires ACTLR_EL3[1] to be set.
[0]	CPUACTLR access control	CPUACTLR_EL1 write access control. The possible values are: 0 The register is not write accessible from Non-secure EL1. This is the reset value. 1 The register is write accessible from Non-secure EL1. Write access from Non-secure EL1 also requires ACTLR_EL3[0] to be set.

To access the ACTLR_EL2:

MRS <Xt>, ACTLR_EL2 ; Read ACTLR_EL2 into Xt
MSR ACTLR_EL2, <Xt> ; Write Xt to ACTLR_EL2

4.3.33 Auxiliary Control Register, EL3

The ACTLR_EL3 characteristics are:

Purpose Controls write access to IMPLEMENTATION DEFINED registers in EL2, such as CPUACTLR, CPUECTLR, L2CTLR, L2ECTLR and L2ACTLR.

Usage constraints This register is accessible as follows:

EL0	EL1 (NS)	EL1 (S)	EL2	EL3 (SCR.NS = 1)	EL3 (SCR.NS = 0)
-	-	-	-	RW	RW

Configurations ACTLR_EL3 is mapped to AArch32 register ACTLR (S). See [Auxiliary Control Register on page 4-196](#).

Attributes ACTLR_EL3 is a 32-bit register.

Figure 4-30 shows the ACTLR_EL3 bit assignments.

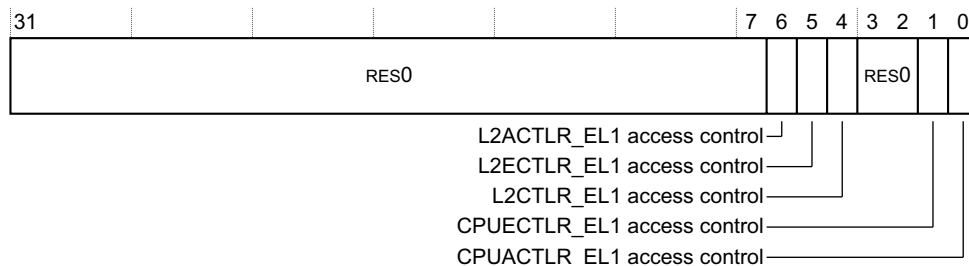

Figure 4-30 ACTLR_EL3 bit assignments

Table 4-69 shows the ACTLR_EL3 bit assignments.

Table 4-69 ACTLR_EL3 bit assignments

Bits	Name	Function
[31:7]	-	Reserved, RES0.
[6]	L2ACTLR access control	L2ACTLR_EL1 write access control. The possible values are: 0 The register is not write accessible from a lower exception level. This is the reset value. 1 The register is write accessible from EL2.
[5]	L2ECTLR access control	L2ECTLR_EL1 write access control. The possible values are: 0 The register is not write accessible from a lower exception level. This is the reset value. 1 The register is write accessible from EL2.
[4]	L2CTLR access control	L2CTLR_EL1 write access control. The possible values are: 0 The register is not write accessible from a lower exception level. This is the reset value. 1 The register is write accessible from EL2.
[3:2]	-	Reserved, RES0.
[1]	CPUECTLR access control	CPUECTLR_EL1 write access control. The possible values are: 0 The register is not write accessible from a lower exception level. This is the reset value. 1 The register is write accessible from EL2.
[0]	CPUACTLR access control	CPUACTLR_EL1 write access control. The possible values are: 0 The register is not write accessible from a lower exception level. This is the reset value. 1 The register is write accessible from EL2.

To access the ACTLR_EL3:

MRS <Xt>, ACTLR_EL3 ; Read ACTLR_EL3 into Xt
MSR ACTLR_EL3, <Xt> ; Write Xt to ACTLR_EL3

4.3.34 Architectural Feature Access Control Register

The CPACR_EL1 characteristics are:

Purpose Controls access to trace functionality and access to registers associated with Advanced SIMD and Floating-point execution.

CPACR_EL1 is part of the Other system registers functional group.

Usage constraints This register is accessible as follows:

EL0	EL1 (NS)	EL1 (S)	EL2	EL3 (SCR.NS = 1)	EL3 (SCR.NS = 0)
-	RW	RW	RW	RW	RW

Configurations CPACR_EL1 is architecturally mapped to AArch32 register CPACR. See *Architectural Feature Access Control Register* on page 4-197.

Attributes CPACR_EL1 is a 32-bit register.

Figure 4-31 shows the CPACR_EL1 bit assignments.



Figure 4-31 CPACR_EL1 bit assignments

Table 4-70 shows the CPACR_EL1 bit assignments.

Table 4-70 CPACR_EL1 bit assignments

Bits	Name	Function
[31:29]	-	Reserved, RES0.
[28]	TTA	Causes access to the Trace functionality to trap to EL1 when executed from EL0 or EL1. This bit is RES0.
[27:22]	-	Reserved, RES0.
[21:20]	FPEN	Traps instructions that access registers associated with Advanced SIMD and Floating-point execution to trap to EL1 when executed from EL0 or EL1. The possible values are: 0bX0 Trap any instruction in EL0 or EL1 that uses registers associated with Advanced SIMD and Floating-point execution. The reset value is 0b00. 0b01 Trap any instruction in EL0 that uses registers associated with Advanced SIMD and Floating-point execution. Instructions in EL1 are not trapped. 0b11 No instructions are trapped. This field is RES0 if Advanced SIMD and Floating-point are not implemented.
[19:0]	-	Reserved, RES0.

To access the CPACR_EL1:

MRS <Xt>, CPACR_EL1 ; Read CPACR_EL1 into Xt
 MSR CPACR_EL1, <Xt> ; Write Xt to CPACR_EL1

4.3.35 System Control Register, EL2

The SCTL_EL2 characteristics are:

Purpose Provides top level control of the system, including its memory system at EL2.

SCTLR_EL2 is part of:

- The Virtual memory control registers functional group.
- The Hypervisor and virtualization registers functional group.

Usage constraints This register is accessible as follows:

EL0	EL1 (NS)	EL1 (S)	EL2	EL3 (SCR.NS = 1)	EL3 (SCR.NS = 0)
-	-	-	RW	RW	RW

Configurations SCTLR_EL2 is architecturally mapped to AArch32 register HSCTLR. See [Hyp System Control Register on page 4-207](#).

Attributes SCTLR_EL2 is a 32-bit register.

Figure 4-32 shows the SCTLR_EL2 bit assignments.

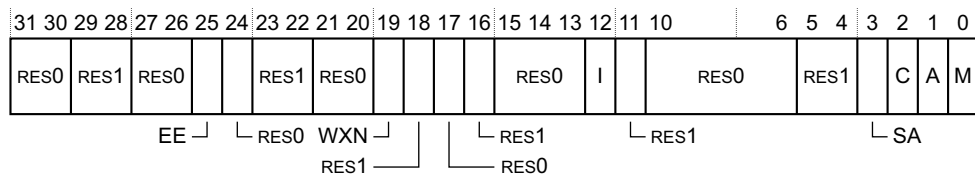

Figure 4-32 SCTLR_EL2 bit assignments

Table 4-71 shows the SCTLR_EL2 bit assignments.

Table 4-71 SCTLR_EL2 bit assignments

Bits	Name	Function
[31:30]	-	Reserved, RES0.
[29:28]	-	Reserved, RES1.
[27:26]	-	Reserved, RES0.
[25]	EE	Exception endianness. The possible values are: 0 Little endian. 1 Big endian. The reset value depends on the value of the CFGEND configuration input.
[24]	-	Reserved, RES0.
[23:22]	-	Reserved, RES1.
[21:20]	-	Reserved, RES0.
[19]	WXN	Force treatment of all memory regions with write permissions as XN. The possible values are: 0 Regions with write permissions are not forced XN. This is the reset value. 1 Regions with write permissions are forced XN.
[18]	-	Reserved, RES1.
[17]	-	Reserved, RES0.

Table 4-71 SCTLR_EL2 bit assignments (continued)

Bits	Name	Function
[16]	-	Reserved, RES1.
[15:13]	-	Reserved, RES0.
[12]	I	Instruction cache enable. The possible values are: 0 Instruction caches disabled. This is the reset value. 1 Instruction caches enabled.
[11]	-	Reserved, RES1.
[10:6]	-	Reserved, RES0.
[5:4]	-	Reserved, RES1.
[3]	SA	Enables stack alignment check. The possible values are: 0 Disables stack alignment check. 1 Enables stack alignment check. This is the reset value.
[2]	C	Global enable for data and unified caches. The possible values are: 0 Disables data and unified caches. This is the reset value. 1 Enables data and unified caches.
[1]	A	Enable alignment fault check The possible values are: 0 Disables alignment fault checking. This is the reset value. 1 Enables alignment fault checking.
[0]	M	Global enable for the EL2 MMU. The possible values are: 0 Disables EL2 MMU. This is the reset value. 1 Enables EL2 MMU.

To access the SCTLR_EL2:

MRS <Xt>, SCTLR_EL2 ; Read SCTLR_EL2 into Xt
MSR SCTLR_EL2, <Xt> ; Write Xt to SCTLR_EL2

4.3.36 Hypervisor Configuration Register

The HCR_EL2 characteristics are:

Purpose Provides configuration control for virtualization, including whether various Non-secure operations are trapped to EL2.
HCR_EL2 is part of the Hypervisor and virtualization registers functional group.

Usage constraints This register is accessible as follows:

EL0	EL1 (NS)	EL1 (S)	EL2	EL3 (SCR.NS = 1)	EL3 (SCR.NS = 0)
-	-	-	RW	RW	RW

Configurations HCR_EL2[31:0] is architecturally mapped to AArch32 register HCR. See [Hyp Configuration Register on page 4-211](#).

HCR_EL2[63:32] is architecturally mapped to AArch32 register HCR2. See *Hyp Configuration Register 2* on page 4-216.

Attributes HCR_EL2 is a 64-bit register.

Figure 4-33 shows the HCR_EL2 bit assignments.

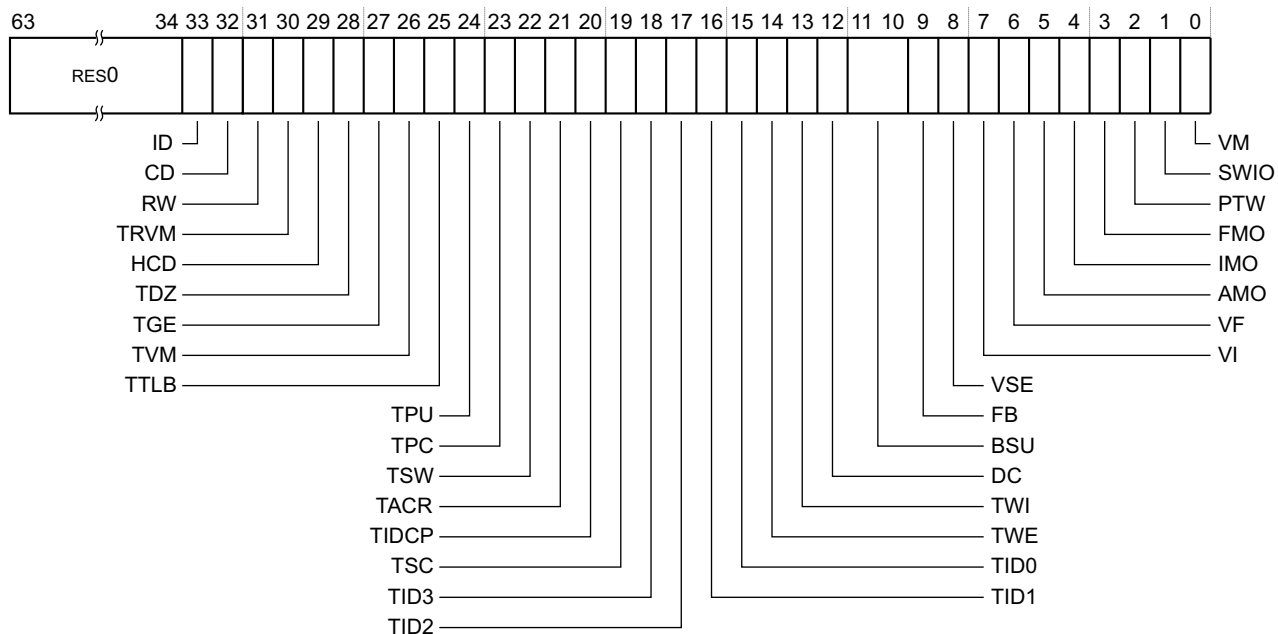

Figure 4-33 HCR_EL2 bit assignments

Table 4-72 shows the HCR_EL2 bit assignments.

Table 4-72 HCR_EL2 bit assignments

Bits	Name	Function
[63:34]	-	Reserved, RES0.
[33]	ID	Disables stage 2 instruction cache. When HCR_EL2.VM is 1, this forces all stage 2 translations for instruction accesses to Normal memory to be Non-cacheable for the EL1/EL0 translation regimes. The possible values are: 0 Has no effect on stage 2 EL1/EL0 translation regime for instruction accesses. This is the reset value. 1 Forces all stage 2 translations for instruction accesses to Normal memory to be Non-cacheable for the EL1/EL0 translation regime.
[32]	CD	Disables stage 2 data cache. When HCR_EL2.VM is 1, this forces all stage 2 translations for data accesses and translation table walks to Normal memory to be Non-cacheable for the EL1/EL0 translation regimes. The possible values are: 0 Has no effect on stage 2 EL1/EL0 translation regime for data access or translation table walks. This is the reset value. 1 Forces all stage 2 translations for data accesses and translation table walks to Normal memory to be Non-cacheable for the EL1/EL0 translation regime.
[31]	RW	Register width control for lower exception levels. The possible values are: 0 Lower levels are all AArch32. This is the reset value. 1 EL1 is AArch64. EL0 is determined by the register width described in the current processing state when executing at EL0.
[30]	TRVM	Trap reads of Virtual Memory controls. ^a The possible values are: 0 Non-secure EL1 reads are not trapped. This is the reset value. 1 Non-secure EL1 reads are trapped to EL2.
[29]	HCD	Reserved, RES0.
[28]	TDZ	Traps DC ZVA instruction. The possible values are: 0 DC ZVA instruction is not trapped. This is the reset value. 1 DC ZVA instruction is trapped to EL2 when executed in Non-secure EL1 or EL0.
[27]	TGE	Traps general exceptions. If this bit is set, and SCR_EL3.NS is set, then: <ul style="list-style-type: none"> • All Non-secure EL1 exceptions are routed to EL2. • For Non-secure EL1, the SCTLR_EL1.M bit is treated as 0 regardless of its actual state other than the purpose of reading the bit. • The HCR_EL2.FMO, HCR_EL2.IMO, and HCR_EL2.AMO bits are treated as 1 regardless of their actual state other than for the purpose of reading the bits. • All virtual interrupts are disabled. • Any implementation defined mechanisms for signaling virtual interrupts are disabled. • An exception return to Non-secure EL1 is treated as an illegal exception return.
[26]	TVM	Trap virtual memory controls. ^a The possible values are: 0 Non-secure EL1 writes are not trapped. This is the reset value. 1 Non-secure EL1 writes are trapped to EL2.
[25]	TTLB	Traps TLB maintenance instructions. ^a The possible values are: 0 Non-secure EL1 TLB maintenance instructions are not trapped. This is the reset value. 1 TLB maintenance instructions executed from Non-secure EL1 that are not UNDEFINED are trapped to EL2.

Table 4-72 HCR_EL2 bit assignments (continued)

Bits	Name	Function
[24]	TPU	Traps cache maintenance instructions to <i>Point of Unification</i> (POU). ^a The possible values are: 0 Cache maintenance instructions are not trapped. This is the reset value. 1 Cache maintenance instructions to the POU executed from Non-secure EL1 or EL0 that are not UNDEFINED are trapped to EL2.
[23]	TPC	Traps data or unified cache maintenance instructions to <i>Point of Coherency</i> (POC). ^a The possible values are: 0 Data or unified cache maintenance instructions are not trapped. This is the reset value. 1 Data or unified cache maintenance instructions by address to the POC executed from Non-secure EL1 or EL0 that are not UNDEFINED are trapped to EL2.
[22]	TSW	Traps data or unified cache maintenance instructions by Set or Way. ^a The possible values are: 0 Data or unified cache maintenance instructions are not trapped. This is the reset value. 1 Data or unified cache maintenance instructions by Set or Way executed from Non-secure EL1 that are not UNDEFINED are trapped to EL2. are not trapped.
[21]	TACR	Traps Auxiliary Control registers. The possible values are: 0 Accesses to Auxiliary Control registers are not trapped. This is the reset value. 1 Accesses to ACTLR in AArch32 state or the ACTLR_EL1 in the AArch64 state from Non-secure EL1 are trapped to EL2.
[20]	TIDCP	Trap Implementation Dependent functionality. When 1, this causes accesses to the following instruction set space executed from Non-secure EL1 to be trapped to EL2: AArch32 All CP15 MCR and MRC instructions as follows: <ul style="list-style-type: none"> • CRn is 9, Opcode1 is 0 to 7, CRm is c0, c1, c2, c5, c6, c7, or c8, and Opcode2 is 0 to 7. • CRn is 10, Opcode1 is 0 to 7, CRm is c0, c1, c4, or c8, and Opcode2 is 0 to 7. • CRn is 11, Opcode1 is 0 to 7, CRm is c0 to c8, or c15, and Opcode2 is 0 to 7. AArch64 Reserved control space for IMPLEMENTATION DEFINED functionality. Accesses from EL0 are UNDEFINED. The reset value is 0.
[19]	TSC	Traps SMC instruction. The possible values are: 0 SMC instruction in not trapped. This is the reset value. 1 SMC instruction executed in Non-secure EL1 is trapped to EL2 for AArch32 and AArch64 Execution states.
[18]	TID3	Traps ID group 3 registers. ^a The possible values are: 0 ID group 3 register accesses are not trapped. This is the reset value. 1 Reads to ID group 3 registers executed from Non-secure EL1 are trapped to EL2.
[17]	TID2	Traps ID group 2 registers. ^a The possible values are: 0 ID group 2 register accesses are not trapped. This is the reset value. 1 Reads to ID group 2 registers and writes to CSSELR and CSSELR_EL1 executed from Non-secure EL1 or EL0, if not UNDEFINED, are trapped to EL2.
[16]	TID1	Traps ID group 1 registers. ^a The possible values are: 0 ID group 1 register accesses are not trapped. This is the reset value. 1 Reads to ID group 1 registers executed from Non-secure EL1 are trapped to EL2.
[15]	TID0	Traps ID group 0 registers. ^a The possible values are: 0 ID group 0 register accesses are not trapped. This is the reset value. 1 Reads to ID group 0 registers executed from Non-secure EL1 are trapped to EL2.

Table 4-72 HCR_EL2 bit assignments (continued)

Bits	Name	Function
[14]	TWE	<p>Traps WFE instruction if it would cause suspension of execution. For example, if there is no pending WFE event. The possible values are:</p> <p>0 WFE instruction is not trapped. This is the reset value.</p> <p>1 WFE instruction executed in Non-secure EL1 or EL0 is trapped to EL2 for AArch32 and AArch64 Execution states.</p>
[13]	TWI	<p>Traps WFI instruction if it causes suspension of execution. For example, if there is no pending WFI event. The possible values are:</p> <p>0 WFI instruction is not trapped. This is the reset value.</p> <p>1 WFI instruction executed in Non-secure EL1 or EL0 is trapped to EL2 for AArch32 and AArch64 Execution states.</p>
[12]	DC	<p>Default cacheable. When this bit is set it causes:</p> <ul style="list-style-type: none"> • SCTLR_EL1.M to behave as 0 for all purposes other than reading the bit. • HCR_EL2.VM to behave as 1 for all purposes other than reading the bit. <p>The memory type produced by the first stage of translation in Non-secure EL1 and EL0 is Non-Shareable, Inner Write-Back Write-Allocate, Outer Write-Back Write-Allocate. The reset value is 0.</p>
[11:10]	BSU	<p>Barrier shareability upgrade. Determines the minimum shareability domain that is supplied to any barrier executed from Non-secure EL1 or EL0. The possible values are:</p> <p>0b00 No effect. This is the reset value.</p> <p>0b01 Inner Shareable.</p> <p>0b10 Outer Shareable.</p> <p>0b11 Full system.</p> <p>This value is combined with the specified level of the barrier held in its instruction, according to the algorithm for combining shareability attributes.</p>

Table 4-72 HCR_EL2 bit assignments (continued)

Bits	Name	Function
[9]	FB	Forces broadcast. ^b The possible values are: 0 Instructions are not broadcast. This is the reset value. 1 Forces instruction broadcast within Inner Shareable domain when executing from Non-secure EL1.
[8]	VSE	Virtual System Error/Asynchronous Abort. The possible values are: 0 Virtual System Error/Asynchronous Abort is not pending by this mechanism. This is the reset value. 1 Virtual System Error/Asynchronous Abort is pending by this mechanism. The virtual System Error/Asynchronous Abort is enabled only when the HCR_EL2.AMO bit is set.
[7]	VI	Virtual IRQ interrupt. The possible values are: 0 Virtual IRQ is not pending by this mechanism. This is the reset value. 1 Virtual IRQ is pending by this mechanism. The virtual IRQ is enabled only when the HCR_EL2.IMO bit is set.
[6]	VF	Virtual FIQ interrupt. The possible values are: 0 Virtual FIQ is not pending by this mechanism. This is the reset value. 1 Virtual FIQ is pending by this mechanism. The virtual FIQ is enabled only when the HCR_EL2.FMO bit is set.
[5]	AMO	Asynchronous abort and error interrupt routing. The possible values are: 0 Asynchronous external Aborts and SError Interrupts while executing at exception levels lower than EL2 are not taken at EL2. Virtual System Error/Asynchronous Abort is disabled. This is the reset value. 1 Asynchronous external Aborts and SError Interrupts while executing at EL2 or lower are taken in EL2 unless routed by SCTLR_EL3.EA bit to EL3. Virtual System Error/Asynchronous Abort is enabled.
[4]	IMO	Physical IRQ routing. The possible values are: 0 Physical IRQ while executing at exception levels lower than EL2 are not taken at EL2. Virtual IRQ interrupt is disabled. This is the reset value. 1 Physical IRQ while executing at EL2 or lower are taken in EL2 unless routed by SCTLR_EL3.IRQ bit to EL3. Virtual IRQ interrupt is enabled.
[3]	FMO	Physical FIQ routing. The possible values are: 0 Physical FIQ while executing at exception levels lower than EL2 are not taken at EL2. Virtual FIQ interrupt is disabled. This is the reset value. 1 Physical FIQ while executing at EL2 or lower are taken in EL2 unless routed by SCTLR_EL3.FIQ bit to EL3. Virtual FIQ interrupt is enabled.
[2]	PTW	Protected Table Walk. When this bit is set, if the stage 2 translation of a translation table access, made as part of a stage 1 translation table walk at EL0 or EL1, maps to Device memory, the access is faulted as a stage 2 Permission fault. The reset value is 0.
[1]	SWIO	Set/Way Invalidation Override. Non-secure EL1 execution of the data cache invalidate by set/way instruction is treated as data cache clean and invalidate by set/way. When this bit is set: <ul style="list-style-type: none"> • DCISW is treated as DCCISW when in the AArch32 Execution state. • DC ISW is treated as DC CISW when in the AArch64 Execution state. This bit is RES1.
[0]	VM	Enables second stage of translation. The possible values are: 0 Disables second stage translation. This is the reset value. 1 Enables second stage translation for execution in Non-secure EL1 and EL0.

- a. See the *ARM® Architecture Reference Manual ARMv8, for ARMv8-A architecture profile* for the registers covered by this setting.
- b. See the *ARM® Architecture Reference Manual ARMv8, for ARMv8-A architecture profile* for the instructions covered by this setting.

To access the HCR_EL2:

```
MRS <Xt>, HCR_EL2 ; Read HCR_EL2 into Xt
MSR HCR_EL2, <Xt> ; Write Xt to HCR_EL2
```

4.3.37 Hyp Debug Control Register

The MDCR_EL2 characteristics are:

Purpose Controls the trapping to Hyp mode of Non-secure accesses, at EL1 or lower, to functions provided by the debug and trace architectures and the Performance Monitor.

Usage constraints This register is accessible as follows:

EL0 (S)	EL1 (NS)	EL1 (S)	EL2	EL3 (SCR.NS = 1)	EL3 (SCR.NS = 0)
-	-	-	RW	RW	RW

- Configurations**
- MDCR_EL2 is architecturally mapped to AArch32 register HDCR. See [Hyp Debug Control Register](#) on page 4-217.
 - This register is accessible only at EL2 or EL3.

Attributes MDCR_EL2 is a 32-bit register.

Figure 4-34 shows the MDCR_EL2 bit assignments.

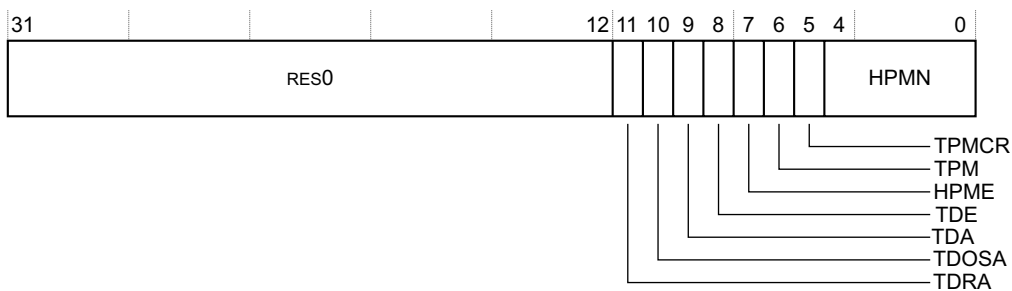

Figure 4-34 MDCR_EL2 bit assignments

[Table 4-73 on page 4-68](#) shows the MDCR_EL2 bit assignments.

Table 4-73 MDCR_EL2 bit assignments

Bits	Name	Function
[31:12]	-	Reserved, RES0.
[11]	TDRA	<p>Trap debug ROM address register access.</p> <p>0 Has no effect on accesses to debug ROM address registers from EL1 and EL0.</p> <p>1 Trap valid Non-secure EL1 and EL0 access to debug ROM address registers to Hyp mode.</p> <p>When this bit is set to 1, any access to the following registers from EL1 or EL0 is trapped to EL2:</p> <ul style="list-style-type: none"> AArch32: DBGDRAR, DBGDSAR. AArch64: MDRAR_EL1. <p>If HCR_EL2.TGE is 1 or MDCR_EL2.TDE is 1, then this bit is ignored and treated as though it is 1 other than for the value read back from MDCR_EL2.</p> <p>On Warm reset, the field resets to 0.</p>
[10]	TDOSA	<p>Trap Debug OS-related register access:</p> <p>0 Has no effect on accesses to OS-related debug registers.</p> <p>1 Trap valid Non-secure accesses to OS-related debug registers to EL2.</p> <p>When this bit is set to 1, any access to the following registers from EL1 or EL0 is trapped to EL2:</p> <ul style="list-style-type: none"> AArch32: DBGOSLAR, DBGOSLSR, DBGOSDLR, DBGPRCR. AArch64: OSLAR_EL1, OSLSR_EL1, OSDLR_EL1, DBGPRCR_EL1. <p>If HCR_EL2.TGE is 1 or MDCR_EL2.TDE is 1, then this bit is ignored and treated as though it is 1 other than for the value read back from MDCR_EL2.</p> <p>On Warm reset, the field resets to 0.</p>
[9]	TDA	<p>Trap Debug Access:</p> <p>0 Has no effect on accesses to Debug registers.</p> <p>1 Trap valid Non-secure accesses to Debug registers to EL2.</p> <p>When this bit is set to 1, any valid Non-secure access to the debug registers from EL1 or EL0, other than the registers trapped by the TDRA and TDOSA bits, is trapped to EL2.</p> <p>If HCR_EL2.TGE is 1 or MDCR_EL2.TDE is 1, then this bit is ignored and treated as though it is 1 other than for the value read back from MDCR_EL2.</p> <p>On Warm reset, the field resets to 0.</p>
[8]	TDE	<p>Trap software debug exceptions:</p> <p>0 Has no effect on software debug exceptions.</p> <p>1 Route Software debug exceptions from Non-secure EL1 and EL0 to EL2. Also enables traps on all debug register accesses to EL2.</p> <p>If HCR_EL2.TGE is 1, then this bit is ignored and treated as though it is 1 other than for the value read back from MDCR_EL2. This bit resets to 0.</p>
[7]	HPME	<p>Hypervisor Performance Monitor Enable:</p> <p>0 EL2 performance monitor counters disabled.</p> <p>1 EL2 performance monitor counters enabled.</p> <p>When this bit is set to 1, the Performance Monitors counters that are reserved for use from EL2 or Secure state are enabled. For more information see the description of the HPMN field.</p> <p>The reset value of this bit is UNKNOWN.</p>
[6]	TPM	<p>Trap Performance Monitor accesses:</p> <p>0 Has no effect on performance monitor accesses.</p> <p>1 Trap Non-secure EL0 and EL1 accesses to Performance Monitors registers that are not UNALLOCATED to EL2.</p> <p>This bit resets to 0.</p>

Table 4-73 MDCR_EL2 bit assignments (continued)

Bits	Name	Function
[5]	TPMCR	<p>Trap PMCR_EL0 accesses:</p> <p>0 Has no effect on PMCR_EL0 accesses.</p> <p>1 Trap Non-secure EL0 and EL1 accesses to PMCR_EL0 to EL2.</p> <p>This bit resets to 0.</p> <p>See the <i>ARM® Architecture Reference Manual ARMv8, for ARMv8-A architecture profile</i> for more information.</p>
[4:0]	HPMN	<p>Hyp Performance Monitor count. Defines the number of Performance Monitors counters that are accessible from Non-secure EL1 and EL0 modes.</p> <p>In Non-secure state, HPMN divides the Performance Monitors counters as follows. For counter n in Non-secure state:</p> <p>For example, If PMnEVCNTR is performance monitor counter n then, in Non-secure state:</p> <ul style="list-style-type: none"> If n is in the range $0 \leq n < \text{HPMN}$, the counter is accessible from EL1 and EL2, and from EL0 if permitted by PMUSERENR_EL0.PMCR_EL0.E enables the operation of counters in this range. If n is in the range $\text{HPMN} \leq n < 6^a$, the counter is accessible only from EL2. MDCR_EL2.HPME enables the operation of counters in this range. <p>If the field is set to 0, then non-secure EL0 or EL1 has no access to any counters.</p> <p>If the field is set to a value greater than six, the behavior is the same as if the value is six.</p> <p>For reads of MDCR_EL2.HPMN by EL2 or higher, if this field is set to 0 or to a value larger than PMCR_EL0.N, the processor returns the value that was written to MDCR_EL2.HPMN.</p> <p>This field resets to 0x6.</p>

a. There are six performance counters, specified by PMCR.N.

To access the MDCR_EL2:

```
MRS <Xt>, MDCR_EL2 ; Read MDCR_EL2 into Xt
MSR MDCR_EL2, <Xt> ; Write Xt to MDCR_EL2
```

4.3.38 Architectural Feature Trap Register, EL2

The CPTR_EL2 characteristics are:

Purpose Controls trapping to EL2 for accesses to CPACR, Trace functionality and registers associated with Advanced SIMD and Floating-point execution. Controls EL2 access to this functionality.

Usage constraints This register is accessible as follows:

EL0	EL1 (NS)	EL1 (S)	EL2	EL3 (SCR.NS = 1)	EL3 (SCR.NS = 0)
-	-	-	RW	RW	RW

Configurations CPTR_EL2 is architecturally mapped to AArch32 register HCPTR. See [Hyp Architectural Feature Trap Register on page 4-221](#).

Attributes CPTR_EL2 is a 32-bit register.

[Figure 4-35 on page 4-70](#) shows the CPTR_EL2 bit assignments.

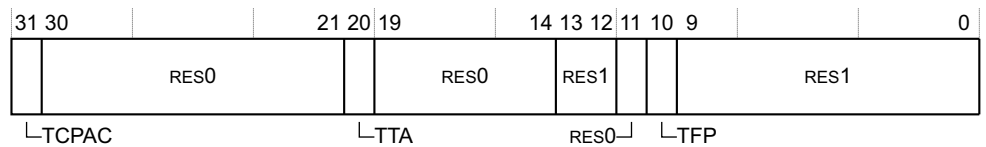

Figure 4-35 CPTR_EL2 bit assignments

Table 4-74 shows the CPTR_EL2 bit assignments.

Table 4-74 CPTR_EL2 bit assignments

Bits	Name	Function
[31]	TCPAC	Traps direct access to CPACR from Non-secure EL1 to EL2. The possible values are: 0 Access to CPACR is not trapped. This is the reset value. 1 Access to CPACR is trapped.
[30:21]	-	Reserved, RES0.
[20]	TTA	Trap Trace Access. Not implemented. RES0.
[19:14]	-	Reserved, RES0.
[13:12]	-	Reserved, RES1.
[11]	-	Reserved, RES0.
[10]	TFP	Traps instructions that access registers associated with Advanced SIMD and Floating-point execution from a lower exception level to EL2, unless trapped to EL1. The possible values are: 0 Instructions are not trapped. This is the reset value if Advanced SIMD and Floating-point are implemented. 1 Instructions are trapped. This is always the value if Advanced SIMD and Floating-point are not implemented.
[9:0]	-	Reserved, RES1.

To access the CPTR_EL2:

MRS <Xt>, CPTR_EL2 ; Read CPTR_EL2 into Xt
MSR CPTR_EL2, <Xt> ; Write Xt to CPTR_EL2

4.3.39 Hyp System Trap Register

The HSTR_EL2 characteristics are:

Purpose Controls access to ThumbEE and coprocessor registers at lower exception levels in AArch32.

Usage constraints This register is accessible as follows:

EL0	EL1 (NS)	EL1 (S)	EL2	EL3 (SCR.NS = 1)	EL3 (SCR.NS = 0)
-	-	-	RW	RW	RW

Configurations HSTR_EL2 is architecturally mapped to AArch32 register HSTR. See [Hyp System Trap Register on page 4-236](#).

Attributes HSTR_EL2 is a 32-bit register.

Figure 4-36 shows the HSTR_EL2 bit assignments.

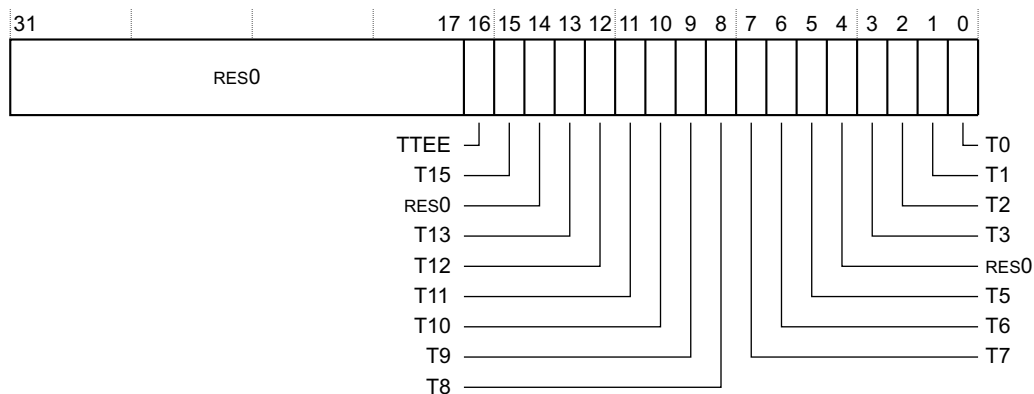

Figure 4-36 HSTR_EL2 bit assignments

Table 4-75 shows the HSTR_EL2 bit assignments.

Table 4-75 HSTR_EL2 bit assignments

Bits	Name	Function
[31:17]	-	Reserved, RES0.
[16]	TTEE	Trap T32EE. This value is: 0 T32EE is not supported.
[15]	T15	Trap coprocessor primary register CRn = 15. The possible values are: 0 Has no effect on Non-secure accesses to CP15 registers. 1 Trap valid Non-secure accesses to coprocessor primary register CRn = 15 to Hyp mode. The reset value is 0.
[14]	-	Reserved, RES0.
[13]	T13	Trap coprocessor primary register CRn = 13. The possible values are: 0 Has no effect on Non-secure accesses to CP15 registers. 1 Trap valid Non-secure accesses to coprocessor primary register CRn = 13 to Hyp mode. The reset value is 0.
[12]	T12	Trap coprocessor primary register CRn = 12. The possible values are: 0 Has no effect on Non-secure accesses to CP15 registers. 1 Trap valid Non-secure accesses to coprocessor primary register CRn = 12 to Hyp mode. The reset value is 0.
[11]	T11	Trap coprocessor primary register CRn = 11. The possible values are: 0 Has no effect on Non-secure accesses to CP15 registers. 1 Trap valid Non-secure accesses to coprocessor primary register CRn = 11 to Hyp mode. The reset value is 0.
[10]	T10	Trap coprocessor primary register CRn = 10. The possible values are: 0 Has no effect on Non-secure accesses to CP15 registers. 1 Trap valid Non-secure accesses to coprocessor primary register CRn = 10 to Hyp mode. The reset value is 0.

Table 4-75 HSTR_EL2 bit assignments (continued)

Bits	Name	Function
[9]	T9	Trap coprocessor primary register CRn = 9. The possible values are: 0 Has no effect on Non-secure accesses to CP15 registers. 1 Trap valid Non-secure accesses to coprocessor primary register CRn = 9 to Hyp mode. The reset value is 0.
[8]	T8	Trap coprocessor primary register CRn = 8. The possible values are: 0 Has no effect on Non-secure accesses to CP15 registers. 1 Trap valid Non-secure accesses to coprocessor primary register CRn = 8 to Hyp mode. The reset value is 0.
[7]	T7	Trap coprocessor primary register CRn = 7. The possible values are: 0 Has no effect on Non-secure accesses to CP15 registers. 1 Trap valid Non-secure accesses to coprocessor primary register CRn = 7 to Hyp mode. The reset value is 0.
[6]	T6	Trap coprocessor primary register CRn = 6. The possible values are: 0 Has no effect on Non-secure accesses to CP15 registers. 1 Trap valid Non-secure accesses to coprocessor primary register CRn = 6 to Hyp mode. The reset value is 0.
[5]	T5	Trap coprocessor primary register CRn = 5. The possible values are: 0 Has no effect on Non-secure accesses to CP15 registers. 1 Trap valid Non-secure accesses to coprocessor primary register CRn = 5 to Hyp mode. The reset value is 0.
[4]	-	Reserved, RES0.
[3]	T3	Trap coprocessor primary register CRn = 3. The possible values are: 0 Has no effect on Non-secure accesses to CP15 registers. 1 Trap valid Non-secure accesses to coprocessor primary register CRn = 3 to Hyp mode. The reset value is 0.
[2]	T2	Trap coprocessor primary register CRn = 2. The possible values are: 0 Has no effect on Non-secure accesses to CP15 registers. 1 Trap valid Non-secure accesses to coprocessor primary register CRn = 2 to Hyp mode. The reset value is 0.
[1]	T1	Trap coprocessor primary register CRn = 1. The possible values are: 0 Has no effect on Non-secure accesses to CP15 registers. 1 Trap valid Non-secure accesses to coprocessor primary register CRn = 1 to Hyp mode. The reset value is 0.
[0]	T0	Trap coprocessor primary register CRn = 0. The possible values are: 0 Has no effect on Non-secure accesses to CP15 registers. 1 Trap valid Non-secure accesses to coprocessor primary register CRn = 0 to Hyp mode. The reset value is 0.

To access the HSTR_EL2:

MRS <Xt>, HSTR_EL2 ; Read HSTR_EL2 into Xt
MSR HSTR_EL2, <Xt> ; Write Xt to HSTR_EL2

4.3.40 Hyp Auxiliary Configuration Register

The processor does not implement HACR_EL2, so this register is always RES0.

4.3.41 System Control Register, EL3

The SCTLR_EL3 characteristics are:

Purpose Provides top level control of the system, including its memory system at EL3.

SCTLR_EL3 is part of the Virtual memory control registers functional group.

Usage constraints This register is accessible as follows:

EL0	EL1 (NS)	EL1 (S)	EL2	EL3 (SCR.NS = 1)	EL3 (SCR.NS = 0)
-	-	-	-	RW	RW

Configurations SCTLR_EL3 is mapped to AArch32 register SCTLR(S). See [System Control Register on page 4-191](#).

Attributes SCTLR_EL3 is a 32-bit register.

Figure 4-37 shows the SCTLR_EL3 bit assignments.

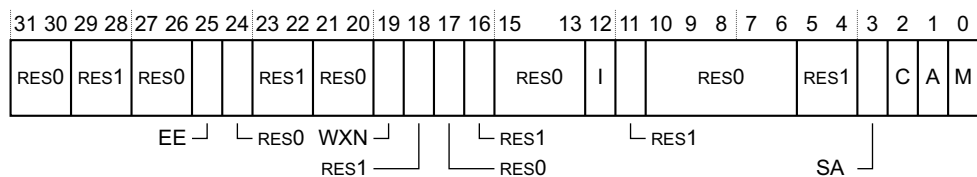

Figure 4-37 SCTLR_EL3 bit assignments

Table 4-76 shows the SCTRLR_EL3 bit assignments.

Table 4-76 SCTRLR_EL3 bit assignments

Bits	Name	Function				
[31:30]	-	Reserved, RES0.				
[29:28]	-	Reserved, RES1.				
[27:26]	-	Reserved, RES0.				
[25]	EE	Exception endianness. This bit controls the endianness for: <ul style="list-style-type: none"> Explicit data accesses at EL3. Stage 1 translation table walks at EL3. The possible values are: <table> <tr> <td>0</td> <td>Little endian. This is the reset value.</td> </tr> <tr> <td>1</td> <td>Big endian.</td> </tr> </table>	0	Little endian. This is the reset value.	1	Big endian.
0	Little endian. This is the reset value.					
1	Big endian.					
[24]	-	Reserved, RES0.				
[23:22]	-	Reserved, RES1.				
[21:20]	-	Reserved, RES0.				
[19]	WXN	Force treatment of all memory regions with write permissions as XN. The possible values are: <table> <tr> <td>0</td> <td>Regions with write permissions are not forced XN. This is the reset value.</td> </tr> <tr> <td>1</td> <td>Regions with write permissions are forced XN.</td> </tr> </table>	0	Regions with write permissions are not forced XN. This is the reset value.	1	Regions with write permissions are forced XN.
0	Regions with write permissions are not forced XN. This is the reset value.					
1	Regions with write permissions are forced XN.					
[18]	-	Reserved, RES1.				
[17]	-	Reserved, RES0.				
[16]	-	Reserved, RES1.				
[15:13]	-	Reserved, RES0.				
[12]	I	Global instruction cache enable. The possible values are: <table> <tr> <td>0</td> <td>Instruction caches disabled. This is the reset value.</td> </tr> <tr> <td>1</td> <td>Instruction caches enabled.</td> </tr> </table>	0	Instruction caches disabled. This is the reset value.	1	Instruction caches enabled.
0	Instruction caches disabled. This is the reset value.					
1	Instruction caches enabled.					
[11]	-	Reserved, RES1.				
[10:6]	-	Reserved, RES0.				
[5:4]	-	Reserved, RES1.				
[3]	SA	Enables stack alignment check. The possible values are: <table> <tr> <td>0</td> <td>Disables stack alignment check.</td> </tr> <tr> <td>1</td> <td>Enables stack alignment check. This is the reset value.</td> </tr> </table>	0	Disables stack alignment check.	1	Enables stack alignment check. This is the reset value.
0	Disables stack alignment check.					
1	Enables stack alignment check. This is the reset value.					
[2]	C	Global enable for data and unifies caches. The possible values are: <table> <tr> <td>0</td> <td>Disables data and unified caches. This is the reset value.</td> </tr> <tr> <td>1</td> <td>Enables data and unified caches.</td> </tr> </table>	0	Disables data and unified caches. This is the reset value.	1	Enables data and unified caches.
0	Disables data and unified caches. This is the reset value.					
1	Enables data and unified caches.					
[1]	A	Enable alignment fault check The possible values are: <table> <tr> <td>0</td> <td>Disables alignment fault checking. This is the reset value.</td> </tr> <tr> <td>1</td> <td>Enables alignment fault checking.</td> </tr> </table>	0	Disables alignment fault checking. This is the reset value.	1	Enables alignment fault checking.
0	Disables alignment fault checking. This is the reset value.					
1	Enables alignment fault checking.					
[0]	M	Global enable for the EL3 MMU. The possible values are: <table> <tr> <td>0</td> <td>Disables EL3 MMU. This is the reset value.</td> </tr> <tr> <td>1</td> <td>Enables EL3 MMU.</td> </tr> </table>	0	Disables EL3 MMU. This is the reset value.	1	Enables EL3 MMU.
0	Disables EL3 MMU. This is the reset value.					
1	Enables EL3 MMU.					

To access the SCTLR_EL3:

MRS <Xt>, SCTLR_EL3 ; Read SCTLR_EL3 into Xt
 MSR SCTLR_EL3, <Xt> ; Write Xt to SCTLR_EL3

4.3.42 Secure Configuration Register

The SCR_EL3 characteristics are:

- Purpose** Defines the configuration of the security state. SCR_EL3 specifies:
- Security state of EL0 and EL1, either Secure or Non-secure.
 - Register width at lower exception levels.
 - The exception level that the processor takes exceptions at, if an IRQ, FIQ, or external abort occurs.

SCR_EL3 is part of the Security registers functional group.

Usage constraints This register is accessible as follows:

EL0	EL1 (NS)	EL1 (S)	EL2	EL3 (SCR.NS = 1)	EL3 (SCR.NS = 0)
-	-	-	-	RW	RW

Configurations SCR_EL3 is mapped to AArch32 register SCR. See *Secure Configuration Register on page 4-199*.

Attributes SCR_EL3 is a 32-bit register.

Figure 4-38 shows the SCR_EL3 bit assignments.

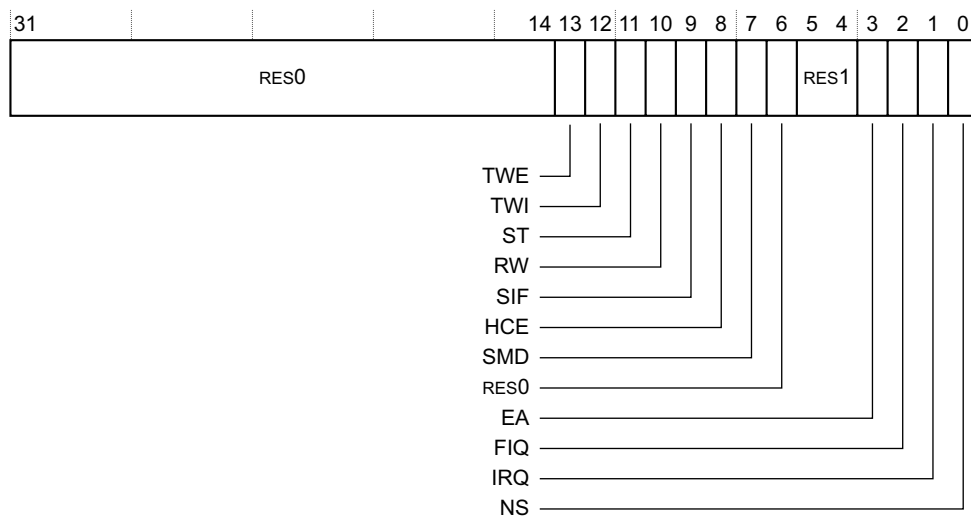

Figure 4-38 SCR_EL3 bit assignments

Table 4-77 shows the SCR_EL3 bit assignments.

Table 4-77 SCR_EL3 bit assignments

Bits	Name	Function
[31:14]	-	Reserved, RES0.
[13]	TWE	<p>Traps WFE instructions. The possible values are:</p> <p>0 WFE instructions are not trapped. This is the reset value.</p> <p>1 WFE instructions executed in AArch32 or AArch64 from EL2, EL1 or EL0 are trapped to EL3 if the instruction would otherwise cause suspension of execution, that is if:</p> <ul style="list-style-type: none"> • The event register is not set. • There is not a pending WFE wakeup event. • The instruction is not trapped at EL2 or EL1. <p>See the <i>ARM® Architecture Reference Manual ARMv8, for ARMv8-A architecture profile</i> for more information.</p>
[12]	TWI	<p>Traps WFI instructions. The possible values are:</p> <p>0 WFI instructions are not trapped. This is the reset value.</p> <p>1 WFI instructions executed in AArch32 or AArch64 from EL2, EL1 or EL0 are trapped to EL3 if the instruction would otherwise cause suspension of execution, that is if there is not a pending WFI wakeup event and the instruction is not trapped at EL2 or EL1.</p> <p>See the <i>ARM® Architecture Reference Manual ARMv8, for ARMv8-A architecture profile</i> for more information.</p>
[11]	ST	<p>Enable Secure EL1 access to CNTPS_TVAL_EL1, CNTS_CTL_EL1, and CNTPS_CVAL_EL1 registers. The possible values are:</p> <p>0 Registers accessible only in EL3. This is the reset value.</p> <p>1 Registers accessible in EL3 and EL1 when SCR_EL3.NS is 0.</p>

Table 4-77 SCR_EL3 bit assignments (continued)

Bits	Name	Function
[10]	RW	Register width control for lower exception levels. The possible values are: 0 Lower levels are all AArch32. This is the reset value. 1 The next lower level is AArch64.
[9]	SIF	Secure Instruction Fetch. When the processor is in Secure state, this bit disables instruction fetches from Non-secure memory. The possible values are: 0 Secure state instruction fetches from Non-secure memory are permitted. This is the reset value. 1 Secure state instruction fetches from Non-secure memory are not permitted.
[8]	HCE	Hyp Call enable. This bit enables the use of HVC instructions. The possible values are: 0 The HVC instruction is UNDEFINED at all exception levels. This is the reset value. 1 The HVC instruction is enabled at EL1, EL2 or EL3.
[7]	SMD	SMC instruction disable. The possible values are: 0 The SMC instruction is enabled at EL1, EL2, and EL3. This is the reset value. 1 The SMC instruction is UNDEFINED at all exception levels. At EL1, in the Non-secure state, the HCR_EL2.TSC bit has priority over this control.
[6]	-	Reserved, RES0.
[5:4]	-	Reserved, RES1.
[3]	EA	External Abort and SError interrupt Routing. This bit controls which mode takes external aborts. The possible values are: 0 External Aborts and SError Interrupts while executing at exception levels other than EL3 are not taken in EL3. This is the reset value. 1 External Aborts and SError Interrupts while executing at all exception levels are taken in EL3.
[2]	FIQ	Physical FIQ Routing. The possible values are: 0 Physical FIQ while executing at exception levels other than EL3 are not taken in EL3. This is the reset value. 1 Physical FIQ while executing at all exception levels are taken in EL3.
[1]	IRQ	Physical IRQ Routing. The possible values are: 0 Physical IRQ while executing at exception levels other than EL3 are not taken in EL3. 1 Physical IRQ while executing at all exception levels are taken in EL3.
[0]	NS	Non-secure bit. The possible values are. The possible values are: 0 EL0 and EL1 are in Secure state, memory accesses from those exception levels can access Secure memory. This is the reset value. 1 EL0 and EL1 are in Non-secure state, memory accesses from those exception levels cannot access Secure memory.

To access the SCR_EL3:

```
MRS <Xt>, SCR_EL3 ; Read SCR_EL3 into Xt
MSR SCR_EL3, <Xt> ; Write Xt to SCR_EL3
```

4.3.43 Secure Debug Enable Register

The SDER32_EL3 characteristics are:

Purpose Allows access to the AArch32 register SDER only from AArch64 state. Its value has no effect on execution in AArch64 state.

Usage constraints This register is accessible as follows:

EL0	EL1 (NS)	EL1 (S)	EL2	EL3 (SCR.NS = 1)	EL3 (SCR.NS = 0)
-	-	-	-	RW	RW

Configurations SDER32_EL3 is architecturally mapped to AArch32 register SDER. See [Secure Debug Enable Register on page 4-201](#).

Attributes SDER32_EL3 is a 32-bit register.

Figure 4-39 shows the SDER32_EL3 bit assignments.

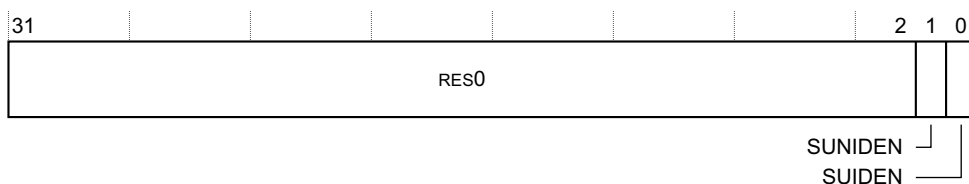

Figure 4-39 SDER32_EL3 bit assignments

Table 4-78 shows the SDER32_EL3 bit assignments.

Table 4-78 SDER32_EL3 bit assignments

Bits	Name	Function
[31:2]	-	Reserved, RES0.
[1]	SUNIDEN	Secure User Non-invasive Debug Enable. The possible values are: 0 Non-invasive debug not permitted in Secure EL0 mode. This is the Warm reset value. 1 Non-invasive debug permitted in Secure EL0 mode.
[0]	SUIDEN	Secure User Invasive Debug Enable. The possible values are: 0 Invasive debug not permitted in Secure EL0 mode. This is the Warm reset value. 1 Invasive debug permitted in Secure EL0 mode.

To access the SDER32_EL3:

MRS <Xt>, SDER32_EL3 ; Read SDER32_EL3 into Xt
MSR SDER32_EL3, <Xt> ; Write Xt to SDER32_EL3

4.3.44 Translation Table Base Register 0, EL1

The TTBR0_EL1 characteristics are:

Purpose Holds the base address of translation table 0, and information about the memory it occupies. This is one of the translation tables for the stage 1 translation of memory accesses from modes other than Hyp mode.

Usage constraints This register is accessible as follows:

EL0	EL1 (NS)	EL1 (S)	EL2	EL3 (SCR.NS = 1)	EL3 (SCR.NS = 0)
-	RW	RW	RW	RW	RW

Any of the fields in this register are permitted to be cached in a TLB.

Configurations TTBR0_EL1 is architecturally mapped to AArch32 register TTBR0. See [Translation Table Base Register 0](#) on page 4-224

Attributes TTBR0_EL1 is 64-bit register.

Figure 4-40 shows the TTBR0_EL1 bit assignments.

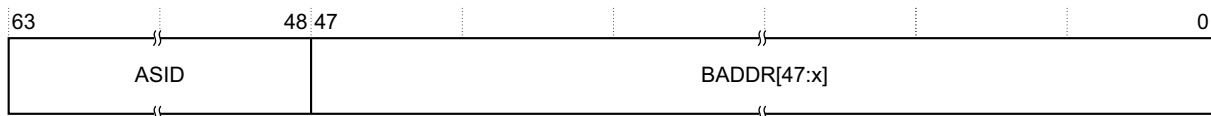

Figure 4-40 TTBR0_EL1 bit assignments

Table 4-79 shows the TTBR0_EL1 bit assignments.

Table 4-79 TTBR0_EL1 bit assignments

Bits	Name	Function
[63:48]	ASID	An ASID for the translation table base address. The TCR_EL1.A1 field selects either TTBR0_EL1.ASID or TTBR1_EL1.ASID.
[47:0]	BADDR[47:x]	Translation table base address, bits[47:x]. Bits [x-1:0] are RES0. x is based on the value of TCR_EL1.T0SZ, the stage of translation, and the memory translation granule size. For instructions on how to calculate it, see the <i>ARM® Architecture Reference Manual ARMv8, for ARMv8-A architecture profile</i> The value of x determines the required alignment of the translation table, that must be aligned to 2 ^x bytes. If bits [x-1:0] are not all zero, this is a misaligned Translation Table Base Address. Its effects are CONSTRAINED UNPREDICTABLE, where bits [x-1:0] are treated as if all the bits are zero. The value read back from those bits is the value written.

To access the TTBR0_EL1:

MRS <Xt>, TTBR0_EL1 ; Read TTBR0_EL1 into Xt
MSR TTBR0_EL1, <Xt> ; Write Xt to TTBR0_EL1

4.3.45 Translation Table Base Register 1

The TTBR1_EL1 characteristics are:

Purpose Holds the base address of translation table 1, and information about the memory it occupies. This is one of the translation tables for the stage 1 translation of memory accesses at EL0 and EL1.

Usage constraints This register is accessible as follows:

EL0	EL1 (NS)	EL1 (S)	EL2	EL3 (SCR.NS = 1)	EL3 (SCR.NS = 0)
-	RW	RW	RW	RW	RW

Any of the fields in this register are permitted to be cached in a TLB.

Configurations TTBR1_EL1 is architecturally mapped to AArch32 register TTBR1 (NS). See [Translation Table Base Register 1](#) on page 4-226.

Attributes TTBR1_EL1 is a 64-bit register.

Figure 4-41 shows the TTBR1_EL1 bit assignments.

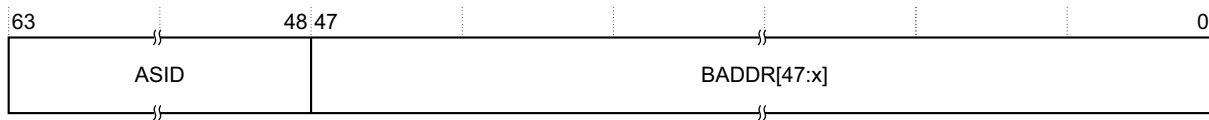

Figure 4-41 TTBR1_EL1 bit assignments

Table 4-80 shows the TTBR1_EL1 bit assignments.

Table 4-80 TTBR1_EL1 bit assignments

Bits	Name	Function
[63:48]	ASID	An ASID for the translation table base address. The TCR_EL1.A1 field selects either TTBR0_EL1.ASID or TTBR1_EL1.ASID.
[47:0]	BADDR[47:x]	<p>Translation table base address, bits[47:x]. Bits [x-1:0] are RES0.</p> <p>x is based on the value of TCR_EL1.T0SZ, the stage of translation, and the memory translation granule size.</p> <p>For instructions on how to calculate it, see the <i>ARM® Architecture Reference Manual ARMv8, for ARMv8-A architecture profile</i>.</p> <p>The value of x determines the required alignment of the translation table, that must be aligned to 2^x bytes. If bits [x-1:0] are not all zero, this is a misaligned Translation Table Base Address. Its effects are CONstrained UNPREDICTABLE, where bits [x-1:0] are treated as if all the bits are zero. The value read back from those bits is the value written.</p>

To access the TTBR1_EL1:

MRS <Xt>, TTBR1_EL1 ; Read TTBR1_EL1 into Xt
MSR TTBR1_EL1, <Xt> ; Write Xt to TTBR1_EL1

4.3.46 Architectural Feature Trap Register, EL3

The CPTR_EL3 characteristics are:

Purpose Controls trapping to EL3 for accesses to CPACR, Trace functionality and registers associated with Advanced SIMD and Floating-point execution. Controls EL3 access to this functionality.

CPTR_EL3 is part of the Security registers functional group.

Usage constraints This register is accessible as follows:

EL0	EL1 (NS)	EL1 (S)	EL2	EL3 (SCR.NS = 1)	EL3 (SCR.NS = 0)
-	-	-	-	RW	RW

Configurations There are no configuration notes.

Attributes CPTR_EL3 is a 32-bit register.

Figure 4-42 on page 4-82 shows the CPTR_EL3 bit assignments.

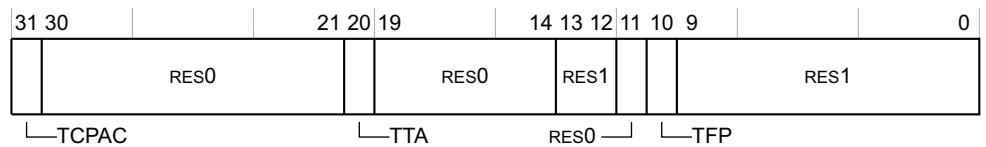

Figure 4-42 CPTR_EL3 bit assignments

Table 4-81 shows the CPTR_EL3 bit assignments.

Table 4-81 CPTR_EL3 bit assignments

Bits	Name	Function
[31]	TCPAC	This causes a direct access to the CPACR_EL1 from EL1 or the CPTR_EL2 from EL2 to trap to EL3 unless it is trapped at EL2. The possible values are: 0 Does not cause access to the CPACR_EL1 or CPTR_EL2 to be trapped. 1 Causes access to the CPACR_EL1 or CPTR_EL2 to be trapped.
[30:21]	-	Reserved, RES0.
[20]	TTA	Trap Trace Access. Not implemented. RES0.
[19:14]	-	Reserved, RES0.
[13:12]	-	Reserved, RES1.
[11]	-	Reserved, RES0.
[10]	TFP	This causes instructions that access the registers associated with Advanced SIMD or floating-point execution to trap to EL3 when executed from any exception level, unless trapped to EL1 or EL2. The possible values are: 0 Does not cause any instruction to be trapped. This is the reset value if the Advanced SIMD and Floating-point Extension is not implemented. 1 Causes any instructions that use the registers associated with Advanced SIMD or floating-point execution to be trapped. This is always the value if the Advanced SIMD and Floating-point Extension is not implemented.
[9:0]	-	Reserved, RES1.

To access the CPTR_EL3:

MRS <Xt>, CPTR_EL3 ; Read CPTR_EL3 into Xt
MSR CPTR_EL3, <Xt> ; Write Xt to CPTR_EL3

4.3.47 Monitor Debug Configuration Register, EL3

The MDCR_EL3 characteristics are:

Purpose Provides configuration options for Security to self-hosted debug.

Usage constraints This register is accessible as follows:

EL0	EL1 (NS)	EL1 (S)	EL2	EL3 (SCR.NS = 1)	EL3 (SCR.NS = 0)
-	-	-	-	RW	RW

Configurations MDCR_EL3 is mapped to AArch32 register SDCR. See [Secure Debug Control Register on page 4-204](#).

Attributes MDCR_EL3 is a 32-bit register.

Figure 4-43 shows the MDCR_EL3 bit assignments.

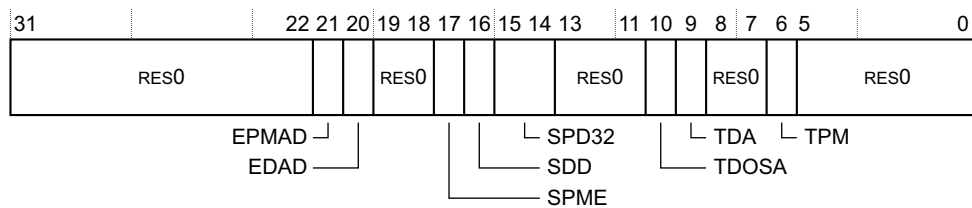

Figure 4-43 MDCR_EL3 bit assignments

Table 4-82 shows the MDCR_EL3 bit assignments.

Table 4-82 MDCR_EL3 bit assignments

Bits	Name	Function
[31:22]	-	Reserved, RES0.
[21]	EPMAD	External debugger access to Performance Monitors registers disabled This disables access to these registers by an external debugger: The possible values are: 0 Access to Performance Monitors registers from external debugger is permitted. 1 Access to Performance Monitors registers from external debugger is disabled, unless overridden by authentication interface.
[20]	EDAD	External debugger access to breakpoint and watchpoint registers disabled. This disables access to these registers by an external debugger: The possible values are: 0 Access to breakpoint and watchpoint registers from external debugger is permitted. 1 Access to breakpoint and watchpoint registers from external debugger is disabled, unless overridden by authentication interface.

Table 4-82 MDCR_EL3 bit assignments (continued)

Bits	Name	Function
[19:18]	-	Reserved, RES0.
[17]	SPME	Secure performance monitors enable. This enables event counting exceptions from Secure state. The possible values are: 0 Event counting prohibited in Secure state. This is the reset value. 1 Event counting allowed in Secure state.
[16]	SDD	AArch64 secure debug disable. Disables Software debug exceptions from Secure state if Secure EL1 is using AArch64, other than from Software breakpoint instructions. The possible values are: 0 Debug exceptions from Secure EL0 are enabled, and debug exceptions from Secure EL1 are enabled if MDSCR_EL1.KDE is 1 and PSTATE.D is 0. 1 Debug exceptions from all exception levels in Secure state are disabled. The reset value is UNKNOWN.
[15:14]	SPD32	AArch32 secure privileged debug. Enables or disables debug exceptions from Secure state if Secure EL1 is using AArch32, other than Software breakpoint instructions. The possible values are: 0b00 Legacy mode. Debug exceptions from Secure EL1 are enabled only if AArch32SelfHostedSecurePrivilegedInvasiveDebugEnabled(). 0b01 Reserved. 0b10 Secure privileged debug disabled. Debug exceptions from Secure EL1 are disabled. 0b11 Secure privileged debug enabled. Debug exceptions from Secure EL1 are enabled. The reset value is UNKNOWN.
[13:11]	-	Reserved, RES0.
[10]	TDOSA	Trap accesses to the OS debug system registers, OSLAR_EL1, OSLSR_EL1, OSDLR_EL1, and DBGPRCR_EL1 OS. 0 Accesses are not trapped. 1 Accesses to the OS debug system registers are trapped to EL3. The reset value is UNKNOWN.
[9]	TDA	Trap accesses to the remaining sets of debug registers to EL3. 0 Accesses are not trapped. 1 Accesses to the remaining debug system registers are trapped to EL3. The reset value is UNKNOWN.
[8:7]	-	Reserved, RES0.
[6]	TPM	Trap Performance Monitors accesses. The possible values are: 0 Accesses are not trapped. 1 Accesses to the Performance Monitor registers are trapped to EL3. The reset value is UNKNOWN.
[5:0]	-	Reserved, RES0.

To access the MDCR_EL3:

MRS <Xt>, MDCR_EL3 ; Read EL3 Monitor Debug Configuration Register
MSR MDCR_EL3, <Xt> ; Write EL3 Monitor Debug Configuration Register

4.3.48 Translation Control Register, EL1

The TCR_EL1 characteristics are:

Purpose Determines which Translation Base Registers defines the base address register for a translation table walk required for stage 1 translation of a memory access from EL0 or EL1 and holds cacheability and shareability information.

TCR_EL1 is part of the Virtual memory control registers functional group.

Usage constraints This register is accessible as follows:

EL0	EL1 (NS)	EL1 (S)	EL2	EL3 (SCR.NS = 1)	EL3 (SCR.NS = 0)
-	RW	RW	RW	RW	RW

Configurations TCR_EL1 is architecturally mapped to AArch32 register TTBCR(NS). See [Hyp Translation Control Register on page 4-232](#).

Attributes TCR_EL1 is a 64-bit register.

Figure 4-44 shows the TCR_EL1 bit assignments.

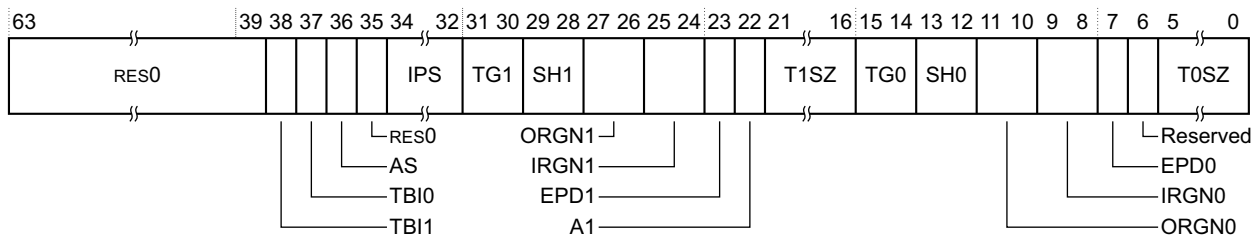

Figure 4-44 TCR_EL1 bit assignments

Table 4-83 shows the TCR_EL1 bit assignments.

Table 4-83 TCR_EL1 bit assignments

Bits	Name	Function
[63:39]	-	Reserved, RES0.
[38]	TBI1	Top Byte Ignored. Indicates whether the top byte of the input address is used for address match for the TTBR1_EL1 region. The possible values are: 0 Top byte used in the address calculation. 1 Top byte ignored in the address calculation.
[37]	TBI0	Top Byte Ignored. Indicates whether the top byte of the input address is used for address match for the TTBR0_EL1 region. The possible values are: 0 Top byte used in the address calculation. 1 Top byte ignored in the address calculation.
[36]	AS	ASID size. The possible values are: 0 8-bit. 1 16-bit.
[35]	-	Reserved, RES0.
[34:32]	IPS	Intermediate Physical Address Size. The possible values are: 0b000 32 bits, 4 GB. 0b001 36 bits, 64 GB. 0b010 40 bits, 1 TB. All other values are reserved.
[31:30]	TG1	TTBR1_EL1 granule size. The possible values are: 0b00 4 KB. 0b10 64 KB.
[29:28]	SH1	Shareability attribute for memory associated with translation table walks using TTBR1_EL1. The possible values are: 0b00 Non-shareable. 0b01 Reserved. 0b10 Outer shareable. 0b11 Inner shareable.
[27:26]	ORGN1	Outer cacheability attribute for memory associated with translation table walks using TTBR1_EL1. The possible values are: 0b00 Normal memory, Outer Non-cacheable. 0b01 Normal memory, Outer Write-Back Write-Allocate Cacheable. 0b10 Normal memory, Outer Write-Through Cacheable. 0b11 Normal memory, Outer Write-Back no Write-Allocate Cacheable.

Table 4-83 TCR_EL1 bit assignments (continued)

Bits	Name	Function
[25:24]	IRGN1	Inner cacheability attribute for memory associated with translation table walks using TTBR1_EL1. The possible values are: 0b00 Normal memory, Inner Non-cacheable. 0b01 Normal memory, Inner Write-Back Write-Allocate Cacheable. 0b10 Normal memory, Inner Write-Through Cacheable. 0b11 Normal memory, Inner Write-Back no Write-Allocate Cacheable.
[23]	EPD1	Translation table walk disable for translations using TTBR1_EL1. Controls whether a translation table walk is performed on a TLB miss for an address that is translated using TTBR1_EL1. The possible values are: 0 Perform translation table walk using TTBR1_EL1. 1 A TLB miss on an address translated from TTBR1_EL1 generates a Translation fault. No translation table walk is performed.
[22]	A1	Selects whether TTBR0_EL1 or TTBR1_EL1 defines the ASID. The possible values are: 0 TTBR0_EL1.ASID defines the ASID. 1 TTBR1_EL1.ASID defines the ASID.
[21:16]	T1SZ	Size offset of the memory region addressed by TTBR1_EL1. The region size is $2^{(64-T1SZ)}$ bytes.
[15:14]	TG0	TTBR0_EL1 granule size. The possible values are: 0b00 4 KB. 0b10 64 KB.
[13:12]	SH0	Shareability attribute for memory associated with translation table walks using TTBR0_EL1. The possible values are: 0b00 Non-shareable. 0b01 Reserved. 0b10 Outer shareable. 0b11 Inner shareable.
[11:10]	ORGN0	Outer cacheability attribute for memory associated with translation table walks using TTBR0_EL1. The possible values are: 0b00 Normal memory, Outer Non-cacheable. 0b01 Normal memory, Outer Write-Back Write-Allocate Cacheable. 0b10 Normal memory, Outer Write-Through Cacheable. 0b11 Normal memory, Outer Write-Back no Write-Allocate Cacheable.
[9:8]	IRGN0	Inner cacheability attribute for memory associated with translation table walks using TTBR0_EL1. The possible values are: 0b00 Normal memory, Inner Non-cacheable. 0b01 Normal memory, Inner Write-Back Write-Allocate Cacheable. 0b10 Normal memory, Inner Write-Through Cacheable. 0b11 Normal memory, Inner Write-Back no Write-Allocate Cacheable.
[7:6]	-	Reserved, RES0.
[5:0]	T0SZ	Size offset of the memory region addressed by TTBR0_EL1. The region size is $2^{(64-T0SZ)}$ bytes.

To access the TCR_EL1:

```
MRS <Xt>, TCR_EL1 ; Read TCR_EL1 into Xt
MSR TCR_EL1, <Xt> ; Write Xt to TCR_EL1
```

4.3.49 Translation Control Register, EL2

The TCR_EL2 characteristics are:

Purpose Controls translation table walks required for stage 1 translation of a memory access from EL2 and holds cacheability and shareability information.

TCR_EL2 is part of:

- The Virtual memory control registers functional group.
- The Hypervisor and virtualization registers functional group.

Usage constraints This register is accessible as follows:

EL0	EL1 (NS)	EL1 (S)	EL2	EL3 (SCR.NS = 1)	EL3 (SCR.NS = 0)
-	-	-	RW	RW	RW

Configurations TCR_EL2 is architecturally mapped to AArch32 register HCTR. See [Hyp Translation Control Register on page 4-232](#).

Attributes TCR_EL2 is a 32-bit register.

Figure 4-45 shows the TCR_EL2 bit assignments.

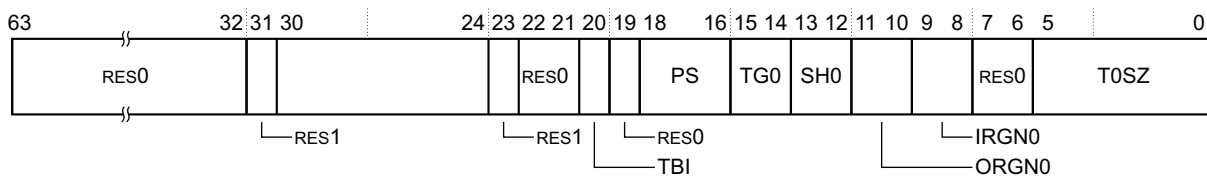

Figure 4-45 TCR_EL2 bit assignments

Table 4-84 shows the TCR_EL2 bit assignments.

Table 4-84 TCR_EL2 bit assignments

Bits	Name	Function
[63:32]	-	Reserved, RES0.
[31]	-	Reserved, RES1.
[30:24]	-	Reserved, RES0.
[23]	-	Reserved, RES1.
[22:21]	-	Reserved, RES0.
[20]	TBI	Top Byte Ignored. Indicates whether the top byte of the input address is used for address match. The possible values are: 0 Top byte used in the address calculation. 1 Top byte ignored in the address calculation.
[19]	-	Reserved, RES0.
[18:16]	PS	Physical address size. The possible values are: 0b000 32 bits, 4 GB. 0b001 36 bits, 64 GB. 0b010 40 bits, 1 TB. Other values are reserved.
[15:14]	TG0	TTBR0_EL2 granule size. The possible values are: 0b00 4 KB. 0b10 64 KB.
[13:12]	SH0	Shareability attribute for memory associated with translation table walks using TTBR0_EL2. The possible values are: 0b00 Non-shareable. 0b01 Reserved. 0b10 Outer shareable. 0b11 Inner shareable.
[11:10]	ORGN0	Outer cacheability attribute for memory associated with translation table walks using TTBR0_EL2. The possible values are: 0b00 Normal memory, Outer Non-cacheable. 0b01 Normal memory, Outer Write-Back Write-Allocate Cacheable. 0b10 Normal memory, Outer Write-Through Cacheable. 0b11 Normal memory, Outer Write-Back no Write-Allocate Cacheable.
[9:8]	IRGN0	Inner cacheability attribute for memory associated with translation table walks using TTBR0_EL2. The possible values are: 0b00 Normal memory, Inner Non-cacheable. 0b01 Normal memory, Inner Write-Back Write-Allocate Cacheable. 0b10 Normal memory, Inner Write-Through Cacheable. 0b11 Normal memory, Inner Write-Back no Write-Allocate Cacheable.
[7:6]	-	Reserved, RES0.
[5:0]	T0SZ	Size offset of the memory region addressed by TTBR0_EL2. The region size is $2^{(64-T0SZ)}$ bytes.

To access the TCR_EL2:

MRS <Xt>, TCR_EL2 ; Read EL2 Translation Control Register
 MSR TCR_EL2, <Xt> ; Write EL2 Translation Control Register

4.3.50 Virtualization Translation Control Register, EL2

The VTCR_EL2 characteristics are:

Purpose Controls the translation table walks required for the stage 2 translation of memory accesses from Non-secure EL0 and EL1, and holds cacheability and shareability information for the accesses.

Usage constraints This register is accessible as follows:

EL0	EL1 (NS)	EL1 (S)	EL2	EL3 (SCR.NS = 1)	EL3 (SCR.NS = 0)
-	-	-	RW	RW	RW

Any of the bits in VTCR_EL2 are permitted to be cached in a TLB.

Configurations VTCR_EL2 is architecturally mapped to AArch32 register VTCR. See [Virtualization Translation Control Register on page 4-233](#).

Attributes VTCR_EL2 is a 32-bit register.

[Figure 4-46](#) shows the VTCR_EL2 bit assignments.

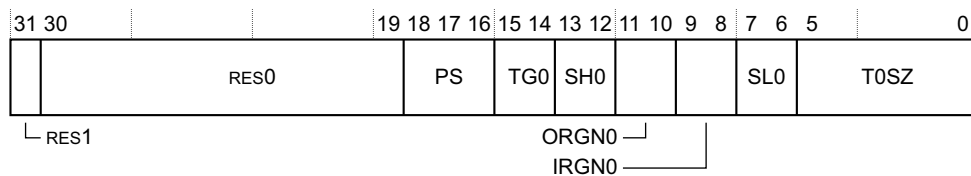

Figure 4-46 VTCR_EL2 bit assignments

Table 4-85 shows the VTCR_EL2 bit assignments.

Table 4-85 VTCR_EL2 bit assignments

Bits	Name	Function
[31]	-	Reserved, RES1.
[30:19]	-	Reserved, RES0.
[18:16]	PS	Physical Address Size. The possible values are: 0b000 32 bits, 4 GB. 0b001 36 bits, 64 GB. 0b010 40 bits, 1 TB. All other values are reserved.
[15:14]	TG0	Granule size for the corresponding VTTBR_EL2. 0b00 4 KB. 0b10 64 KB.
[13:12]	SH0	Shareability attribute for memory associated with translation table walks using VTTBR_EL2. 0b00 Non-shareable. 0b01 Reserved. 0b10 Outer Shareable. 0b11 Inner Shareable.
[11:10]	ORGN0	Outer cacheability attribute for memory associated with translation table walks using VTTBR_EL2. 0b00 Normal memory, Outer Non-cacheable. 0b01 Normal memory, Outer Write-Back Write-Allocate Cacheable. 0b10 Normal memory, Outer Write-Through Cacheable. 0b11 Normal memory, Outer Write-Back no Write-Allocate Cacheable.
[9:8]	IRGN0	Inner cacheability attribute for memory associated with translation table walks using VTTBR_EL2. 0b00 Normal memory, Inner Non-cacheable. 0b01 Normal memory, Inner Write-Back Write-Allocate Cacheable. 0b10 Normal memory, Inner Write-Through Cacheable. 0b11 Normal memory, Inner Write-Back no Write-Allocate Cacheable.
[7:6]	SL0	Starting level of the VTCR_EL2 addressed region.
[5:0]	T0SZ	The size offset of the memory region addressed by VTTBR_EL2. The region size is $2^{(64-T0SZ)}$ bytes.

To access the VTCR_EL2:

```
MRS <Xt>, VTCR_EL2 ; Read VTCR_EL2 into Xt
MSR VTCR_EL2, <Xt> ; Write Xt to VTCR_EL2
```

4.3.51 Domain Access Control Register

The DACR32_EL2 characteristics are:

Purpose Allows access to the AArch32 DACR register from AArch64 state only. Its value has no effect on execution in AArch64 state.

Usage constraints This register is accessible as follows:

EL0	EL1 (NS)	EL1 (S)	EL2	EL3 (SCR.NS = 1)	EL3 (SCR.NS = 0)
-	-	-	RW	RW	RW

Configurations DACR32_EL2 is architecturally mapped to AArch32 register DACR (NS). See [Domain Access Control Register on page 4-235](#).

Attributes DACR32_EL2 is a 32-bit register.

Figure 4-47 shows the DACR32_EL2 bit assignments.

31	30	29	28	27	26	25	24	23	22	21	20	19	18	17	16	15	14	13	12	11	10	9	8	7	6	5	4	3	2	1	0	
D15	D14	D13	D12	D11	D10	D9	D8	D7	D6	D5	D4	D3	D2	D1	D0																	

Figure 4-47 DACR32_EL2 bit assignments

Table 4-86 shows the DACR32_EL2 bit assignments.

Table 4-86 DACR32_EL2 bit assignments

Bits	Name	Function
[31:0]	D<n>, bits [2n+1:2n], for n = 0 to 15	Domain n access permission, where n = 0 to 15. Permitted values are: 0b00 No access. Any access to the domain generates a Domain fault. 0b01 Client. Accesses are checked against the permission bits in the translation tables. 0b11 Manager. Accesses are not checked against the permission bits in the translation tables. The value 0b10 is reserved.

To access the DACR32_EL2:

MRS <Xt>, DACR32_EL2 ; Read DACR32_EL2 into Xt
MSR DACR32_EL2, <Xt> ; Write Xt to DACR32_EL2

4.3.52 Translation Table Base Register 0, EL3

The TTBR0_EL3 characteristics are:

Purpose Holds the base address of the translation table for the stage 1 translation of memory accesses from EL3.

Usage constraints This register is accessible as follows:

EL0	EL1 (NS)	EL1 (S)	EL2	EL3 (SCR.NS = 1)	EL3 (SCR.NS = 0)
-	-	-	-	RW	RW

Configurations TTBR0_EL3 is mapped to AArch32 register TTBR0 (S). See [Translation Table Base Register 0 on page 4-224](#).

Attributes TTBR0_EL3 is a 64-bit register.

Figure 4-48 on page 4-94 shows the TTBR0_EL3 bit assignments.

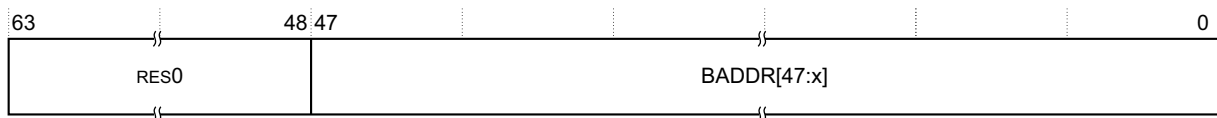

Figure 4-48 TTBR0_EL3 bit assignments

Table 4-87 shows the TTBR0_EL3 bit assignments.

Table 4-87 TTBR0_EL3 bit assignments

Bits	Name	Function
[63:48]	-	Reserved, RES0.
[47:0]	BADDR[47:x]	<p>Translation table base address, bits[47:x]. Bits [x-1:0] are RES0. x is based on the value of TCR_EL1.T0SZ, the stage of translation, and the memory translation granule size.</p> <p>For instructions on how to calculate it, see the <i>ARM® Architecture Reference Manual ARMv8, for ARMv8-A architecture profile</i>.</p> <p>The value of x determines the required alignment of the translation table, that must be aligned to 2^x bytes. If bits [x-1:0] are not all zero, this is a misaligned Translation Table Base Address. Its effects are CONSTRAINED UNPREDICTABLE, where bits [x-1:0] are treated as if all the bits are zero. The value read back from those bits is the value written.</p>

To access the TTBR0_EL3:

```
MRS <Xt>, TTBR0_EL3 ; Read TTBR0_EL3 into Xt
MSR TTBR0_EL3, <Xt> ; Write Xt to TTBR0_EL3
```

4.3.53 Translation Control Register, EL3

The TCR_EL3 characteristics are:

Purpose Controls translation table walks required for stage 1 translation of memory accesses from EL3 and holds cacheability and shareability information for the accesses.

TCR_EL3 is part of the Virtual memory control registers functional group.

Usage constraints This register is accessible as follows:

EL0	EL1 (NS)	EL1 (S)	EL2	EL3 (SCR.NS = 1)	EL3 (SCR.NS = 0)
-	-	-	-	RW	RW

Configurations TCR_EL3 is mapped to AArch32 register TTBR(S).

Attributes TCR_EL3 is a 32-bit register.

Figure 4-49 on page 4-95 shows the TCR_EL3 bit assignments.

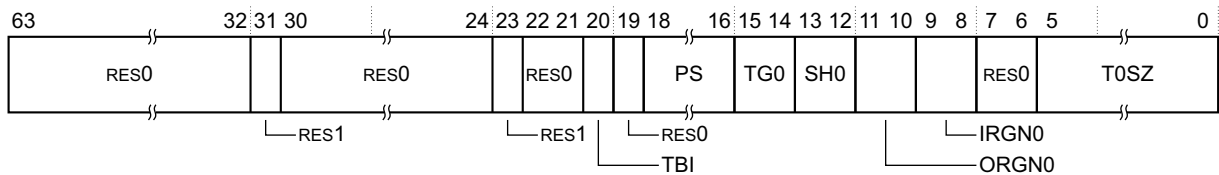

Figure 4-49 TCR_EL3 bit assignments

Table 4-88 shows the TCR_EL3 bit assignments.

Table 4-88 TCR_EL3 bit assignments

Bits	Name	Function
[63:32]	-	Reserved, RES0.
[31]	-	Reserved, RES1.
[30:24]	-	Reserved, RES0.
[23]	-	Reserved, RES1.

Table 4-88 TCR_EL3 bit assignments (continued)

Bits	Name	Function
[22:21]	-	Reserved, RES0.
[20]	TBI	Top Byte Ignored. Indicates whether the top byte of the input address is used for address match. The possible values are: 0 Top byte used in the address calculation. 1 Top byte ignored in the address calculation.
[19]	-	Reserved, RES0.
[18:16]	PS	Physical address size. The possible values are: 0b000 32 bits, 4 GB. 0b001 36 bits, 64 GB. 0b010 40 bits, 1 TB. Other values are reserved.
[15:14]	TG0	TTBR0_EL3 granule size. The possible values are: 0b00 4 KB. 0b10 64 KB.
[13:12]	SH0	Shareability attribute for memory associated with translation table walks using TTBR0_EL3. The possible values are: 0b00 Non-shareable. 0b01 Reserved. 0b10 Outer shareable. 0b11 Inner shareable.
[11:10]	ORGN0	Outer cacheability attribute for memory associated with translation table walks using TTBR0_EL3. The possible values are: 0b00 Normal memory, Outer Non-cacheable. 0b01 Normal memory, Outer Write-Back Write-Allocate Cacheable. 0b10 Normal memory, Outer Write-Through Cacheable. 0b11 Normal memory, Outer Write-Back no Write-Allocate Cacheable.
[9:8]	IRGN0	Inner cacheability attribute for memory associated with translation table walks using TTBR0_EL3. The possible values are: 0b00 Normal memory, Inner Non-cacheable. 0b01 Normal memory, Inner Write-Back Write-Allocate Cacheable. 0b10 Normal memory, Inner Write-Through Cacheable. 0b11 Normal memory, Inner Write-Back no Write-Allocate Cacheable.
[7:6]	-	Reserved, RES0.
[5:0]	T0SZ	Size offset of the memory region addressed by TTBR0_EL3. The region size is $2^{(64-T0SZ)}$ bytes.

To access the TCR_EL3:

MRS <Xt>, TCR_EL3 ; Read EL3 Translation Control Register
MRS TCR_EL3, <Xt> ; Read EL3 Translation Control Register

4.3.54 Auxiliary Memory Attribute Indirection Register, EL1, EL2 and EL3

The processor does not implement AMAIR_EL1, AMAIR_EL2 and AMAIR_EL3, therefore these registers are always RES0.

4.3.55 Auxiliary Fault Status Register 0, EL1, EL2 and EL3

The processor does not implement AFSR0_EL1, AFSR0_EL2 and AFSR0_EL3, therefore these registers are always RES0.

4.3.56 Auxiliary Fault Status Register 1, EL1, EL2 and EL3

The processor does not implement AFSR1_EL1, AFSR1_EL2 and AFSR1_EL3, therefore these registers are always RES0.

4.3.57 Exception Syndrome Register, EL1

The ESR_EL1 characteristics are:

Purpose Holds syndrome information for an exception taken to EL1.

Usage constraints This register is accessible as follows:

EL0	EL1 (NS)	EL1 (S)	EL2	EL3 (SCR.NS = 1)	EL3 (SCR.NS = 0)
-	RW	RW	RW	RW	RW

Configurations ESR_EL1 is architecturally mapped to AArch32 register DFSR (NS). See [Data Fault Status Register on page 4-239](#).

Attributes ESR_EL1 is a 32-bit register.

Figure 4-50 shows the ESR_EL1 bit assignments.

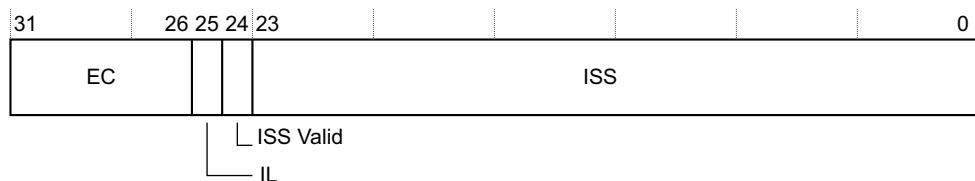

Figure 4-50 ESR_EL1 bit assignments

Table 4-89 shows the ESR_EL1 bit assignments.

Table 4-89 ESR_EL1 bit assignments

Bits	Name	Function
[31:26]	EC	Exception Class. Indicates the reason for the exception that this register holds information about.
[25]	IL	Instruction Length for synchronous exceptions. The possible values are: 0 16-bit. 1 32-bit. This field is 1 for the SError interrupt, instruction aborts, misaligned PC, Stack pointer misalignment, data aborts for which the ISV bit is 0, exceptions caused by an illegal instruction set state, and exceptions using the 0x00 Exception Class.
[24]	ISS Valid	Syndrome valid. The possible values are: 0 ISS not valid, ISS is RES0. 1 ISS valid.
[23:0]	ISS	Syndrome information.

To access the ESR_EL1:

MRS <Xt>, ESR_EL1 ; Read EL1 Exception Syndrome Register
 MSR ESR_EL1, <Xt> ; Write EL1 Exception Syndrome Register

4.3.58 Instruction Fault Status Register, EL2

The IFSR32_EL2 characteristics are:

Purpose Allows access to the AArch32 IFSR register from AArch64 state only. Its value has no effect on execution in AArch64 state.

Usage constraints This register is accessible as follows:

EL0	EL1 (NS)	EL1 (S)	EL2	EL3 (SCR.NS = 1)	EL3 (SCR.NS = 0)
-	-	-	RW	RW	RW

Configurations IFSR32_EL2 is architecturally mapped to AArch32 register IFSR(NS). See [Instruction Fault Status Register on page 4-243](#).

Attributes IFSR32_EL2 is a 32-bit register.

There are two formats for this register. The current translation table format determines which format of the register is used. This section describes:

- [IFSR when using the Short-descriptor translation table format on page 4-243](#).
- [IFSR when using the Long-descriptor translation table format on page 4-244](#).

IFSR32_EL2 when using the Short-descriptor translation table format

[Figure 4-51 on page 4-99](#) shows the IFSR32_EL2 bit assignments when using the Short-descriptor translation table format.

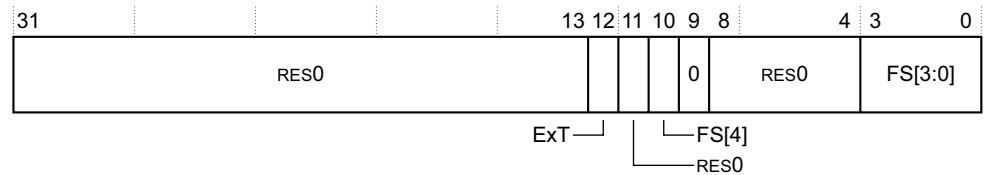

Figure 4-51 IFSR32_EL2 bit assignments for Short-descriptor translation table format

Table 4-90 shows the IFSR32_EL2 bit assignments when using the Short-descriptor translation table format.

Table 4-90 IFSR32_EL2 bit assignments for Short-descriptor translation table format

Bits	Name	Function
[31:13]	-	Reserved, RES0.
[12]	ExT	External abort type. This field indicates whether an AXI Decode or Slave error caused an abort: 0 External abort marked as DECERR. 1 External abort marked as SLVERR. For aborts other than external aborts this bit always returns 0.
[11]	-	Reserved, RES0.
[10]	FS[4]	Part of the Fault Status field. See bits [3:0] in this table.
[9]	-	RAZ.
[8:5]	-	Reserved, RES0.
[4:0]	FS[3:0]	Fault Status bits. This field indicates the type of exception generated. Any encoding not listed is reserved. 0b00010 Debug event. 0b00011 Access flag fault, section. 0b00101 Translation fault, section. 0b00110 Access flag fault, page. 0b00111 Translation fault, page. 0b01000 Synchronous external abort, non-translation. 0b01001 Domain fault, section. 0b01011 Domain fault, page. 0b01100 Synchronous external abort on translation table walk, first level. 0b01101 Permission Fault, Section. 0b01110 Synchronous external abort on translation table walk, second Level. 0b01111 Permission fault, page. 0b10000 TLB conflict abort. 0b11001 Synchronous parity error on memory access. 0b11100 Synchronous parity error on translation table walk, first level. 0b11110 Synchronous parity error on translation table walk, second level.

IFSR32_EL2 when using the Long-descriptor translation table format

Figure 4-52 on page 4-100 shows the IFSR32_EL2 bit assignments when using the Long-descriptor translation table format.

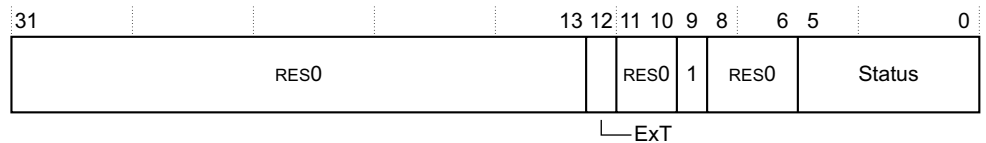

Figure 4-52 IFSR32_EL2 bit assignments for Long-descriptor translation table format

Table 4-91 shows the IFSR32_EL2 bit assignments when using the Long-descriptor translation table format.

Table 4-91 IFSR32_EL2 bit assignments for Long-descriptor translation table format

Bits	Name	Function
[31:13]	-	Reserved, RES0.
[12]	Ext	External abort type. This field indicates whether an AXI Decode or Slave error caused an abort: 0 External abort marked as DECERR. 1 External abort marked as SLVERR. For aborts other than external aborts this bit always returns 0.
[11:10]	-	Reserved, RES0.
[9]	-	RAO.
[8:6]	-	Reserved, RES0.
[5:0]	Status	Fault Status bits. This field indicates the type of exception generated. Any encoding not listed is reserved. 0b000000 Address size fault in TTBR0 or TTBR1. 0b0001LL Translation fault, LL bits indicate level. 0b0010LL Access fault flag, LL bits indicate level. 0b0011LL Permission fault, LL bits indicate level. 0b010000 Synchronous external abort. 0b0101LL Synchronous external abort on translation table walk, LL bits indicate level. 0b011000 Synchronous parity error on memory access. 0b0111LL Synchronous parity error on memory access on translation table walk, LL bits indicate level. 0b100001 Alignment fault. 0b100010 Debug event. 0b110000 TLB conflict abort.

Table 4-92 shows how the LL bits in the Status field encode the lookup level associated with the MMU fault.

Table 4-92 Encodings of LL bits associated with the MMU fault

Bits	Meaning
0b00	Reserved
0b01	Level 1
0b10	Level 2
0b11	Level 3

Note

If a Data Abort exception is generated by an instruction cache maintenance operation when the Long-descriptor translation table format is selected, the fault is reported as a Cache Maintenance fault in the DFSR or HSR with the appropriate Fault Status code. For such exceptions reported in the DFSR, the corresponding IFSR32_EL2 is UNKNOWN.

To access the IFSR32_EL2:

MRS <Xt>, IFSR32_EL2 ; Read IFSR32_EL2 into Xt
MSR IFSR32_EL2, <Xt> ; Write Xt to IFSR32_EL2

Register access is encoded as follows:

Table 4-93 IFSR32_EL2 access encoding

op0	op1	CRn	CRm	op2
11	000	0101	0000	001

4.3.59 Exception Syndrome Register, EL2

The ESR_EL2 characteristics are:

Purpose Holds syndrome information for an exception taken to EL2.

Usage constraints This register is accessible as follows:

EL0	EL1 (NS)	EL1 (S)	EL2	EL3 (SCR.NS = 1)	EL3 (SCR.NS = 0)
-	-	-	RW	RW	RW

Configurations ESR_EL2 is architecturally mapped to AArch32 register HSR. See [Hyp Syndrome Register on page 4-246](#).

Attributes ESR_EL2 is a 32-bit register.

[Figure 4-53](#) shows the ESR_EL2 bit assignments.

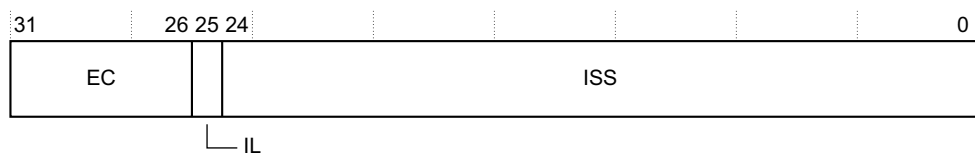

Figure 4-53 ESR_EL2 bit assignments

Table 4-94 shows the ESR_EL2 bit assignments.

Table 4-94 ESR_EL2 bit assignments

Bits	Name	Function
[31:26]	EC	Exception Class. Indicates the reason for the exception that this register holds information about.
[25]	IL	Instruction Length for synchronous exceptions. The possible values are: 0 16-bit. 1 32-bit.
[24]	ISS Valid	Syndrome valid. The possible values are: 0 ISS not valid, ISS is RES0. 1 ISS valid.
[23:0]	ISS	Syndrome information.

To access the ESR_EL2:

MRS <Xt>, ESR_EL2 ; Read EL1 Exception Syndrome Register
MSR ESR_EL2, <Xt> ; Write EL1 Exception Syndrome Register

4.3.60 Exception Syndrome Register, EL3

The ESR_EL3 characteristics are:

Purpose Holds syndrome information for an exception taken to EL3.

Usage constraints This register is accessible as follows:

EL0	EL1 (NS)	EL1 (S)	EL2	EL3 (SCR.NS = 1)	EL3 (SCR.NS = 0)
-	-	-	-	RW	RW

Configurations ESR_EL3 is mapped to AArch32 register DFSR(S). See [Data Fault Status Register on page 4-239](#).

Attributes ESR_EL3 is a 32-bit register.

Figure 4-54 shows the ESR_EL3 bit assignments.



Figure 4-54 ESR_EL3 bit assignments

Table 4-95 shows the ESR_EL3 bit assignments.

Table 4-95 ESR_EL3 bit assignments

Bits	Name	Function
[31:26]	EC	Exception Class. Indicates the reason for the exception that this register holds information about.
[25]	IL	Instruction Length for synchronous exceptions. The possible values are: 0 16-bit. 1 32-bit. This field is 1 for the SError interrupt, instruction aborts, misaligned PC, Stack pointer misalignment, data aborts for which the ISV bit is 0, exceptions caused by an illegal instruction set state, and exceptions using the 0x0 Exception Class.
[24]	ISS Valid	Syndrome valid. The possible values are: 0 ISS not valid, ISS is RES0. 1 ISS valid.
[23:0]	ISS	Syndrome information.

To access the ESR_EL3:

MRS <Xt>, ESR_EL3 ; Read EL3 Exception Syndrome Register
 MSR ESR_EL3, <Xt> ; Write EL3 Exception Syndrome Register

4.3.61 Fault Address Register, EL1

The FAR_EL1 characteristics are:

Purpose Holds the faulting Virtual Address for all synchronous instruction or data aborts, or exceptions from a misaligned PC or a Watchpoint debug event, taken to EL1.

Usage constraints This register is accessible as follows:

EL0	EL1 (NS)	EL1 (S)	EL2	EL3 (SCR.NS = 1)	EL3 (SCR.NS = 0)
-	RW	RW	RW	RW	RW

Configurations FAR_EL1[31:0] is architecturally mapped to AArch32 register DFAR (NS). See [Data Fault Address Register on page 4-247](#).

FAR_EL1[63:32] is architecturally mapped to AArch32 register IFAR (NS). See [Instruction Fault Address Register on page 4-248](#).

Attributes FAR_EL1 is a 64-bit register.

Figure 4-55 shows the FAR_EL1 bit assignments.

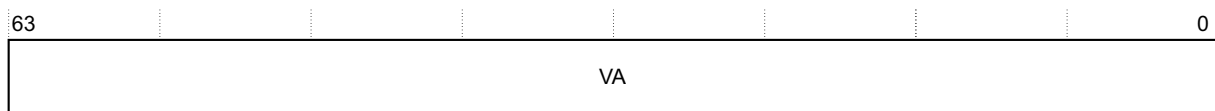

Figure 4-55 FAR_EL1 bit assignments

Table 4-96 shows the FAR_EL1 bit assignments.

Table 4-96 FAR_EL1 bit assignments

Bits	Name	Function
[63:0]	VA	The faulting Virtual Address for all synchronous instruction or data aborts, or an exception from a misaligned PC, taken in EL1. If a memory fault that sets the FAR is generated from one of the data cache instructions, this field holds the address specified in the register argument of the instruction.

To access the FAR_EL1:

MRS <Xt>, FAR_EL1 ; Read EL1 Fault Address Register
MSR FAR_EL1, <Xt> ; Write EL1 Fault Address Register

4.3.62 Fault Address Register, EL2

The FAR_EL2 characteristics are:

Purpose Holds the faulting Virtual Address for all synchronous instruction or data aborts, or exceptions from a misaligned PC or a Watchpoint debug event, taken to EL2.

Usage constraints This register is accessible as follows:

EL0	EL1 (NS)	EL1 (S)	EL2	EL3 (SCR.NS = 1)	EL3 (SCR.NS = 0)
-	-	-	RW	RW	RW

Configurations FAR_EL2[31:0] is architecturally mapped to AArch32 registers:

- HDFAR. See [Hyp Data Fault Address Register on page 4-249](#).
- DFAR (S). See [Data Fault Address Register on page 4-247](#).

FAR_EL2[63:32] is architecturally mapped to AArch32 registers:

- HIFAR. See [Hyp Instruction Fault Address Register on page 4-250](#).
- IFAR (S). See [Instruction Fault Address Register on page 4-248](#).

Attributes FAR_EL2 is a 64-bit register.

Figure 4-56 shows the FAR_EL2 bit assignments.

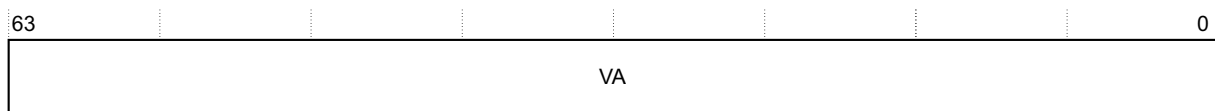

Figure 4-56 FAR_EL2 bit assignments

Table 4-97 on page 4-104 shows the FAR_EL2 bit assignments.

Table 4-97 FAR_EL2 bit assignments

Bits	Name	Function
[63:0]	VA	The faulting Virtual Address for all synchronous instruction or data aborts, or an exception from a misaligned PC, taken in EL2. If a memory fault that sets the FAR is generated from one of the data cache instructions, this field holds the address specified in the register argument of the instruction.

To access the FAR_EL2:

MRS <Xt>, FAR_EL2 ; Read EL2 Fault Address Register
MSR FAR_EL2, <Xt> ; Write EL2 Fault Address Register

4.3.63 Hypervisor IPA Fault Address Register, EL2

The HPFAR_EL2 characteristics are:

Purpose Holds the faulting IPA for some aborts on a stage 2 translation taken to EL2.

Usage constraints This register is accessible as follows:

EL0	EL1 (NS)	EL1 (S)	EL2	EL3 (SCR.NS = 1)	EL3 (SCR.NS = 0)
-	-	-	RW	RW	RW

Configurations HPFAR_EL2[31:0] is mapped to AArch32 register HPFAR. See [Hyp IPA Fault Address Register on page 4-250](#).

Attributes HPFAR_EL2 is a 64-bit register.

Figure 4-57 shows the HPFAR_EL2 bit assignments.

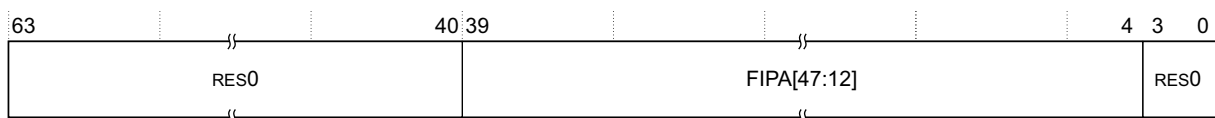

Figure 4-57 HPFAR_EL2 bit assignments

Table 4-98 on page 4-104 shows the HPFAR_EL2 bit assignments.

Table 4-98 HPFAR_EL2 bit assignments

Bits	Name	Function
[63:40]	-	Reserved, RES0.
[39:4]	FIPA[47:12]	Bits [47:12] of the faulting intermediate physical address. The equivalent upper bits in this field are RES0.
[3:0]	-	Reserved, RES0.

To access the HPFAR_EL:

MRS <Xt>, HPFAR_EL2 ; Read EL2 Fault Address Register
MSR HPFAR_EL2, <Xt> ; Write EL2 Fault Address Register

4.3.64 L2 Control Register

The L2CTLR_EL1 characteristics are:

Purpose Provides IMPLEMENTATION DEFINED control options for the L2 memory system.

Usage constraints This register is accessible as follows:

EL0	EL1 (NS)	EL1 (S)	EL2	EL3 (SCR.NS = 1)	EL3 (SCR.NS = 0)
-	RW	RW	RW	RW	RW

Note

L2CTLR_EL1 is writeable. However, all writes to this register are ignored.

Configurations L2CTLR_EL1 is architecturally mapped to the AArch32 L2CTLR register. See [L2 Control Register on page 4-251](#).

There is one L2CTLR_EL1 for the Cortex-A53 processor.

Attributes L2CTLR_EL1 is a 32-bit register.

Figure 4-58 shows the L2CTLR_EL1 bit assignments.

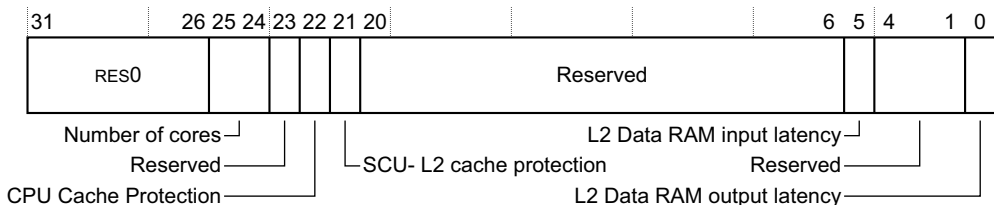

Figure 4-58 L2CTLR_EL1 bit assignments

Table 4-99 shows the L2CTLR_EL1 bit assignments.

Table 4-99 L2CTLR_EL1 bit assignments

Bits	Name	Function
[31:26]	-	Reserved, RES0.
[25:24]	Number of cores	Number of cores present: 0b00 One core, core 0. 0b01 Two cores, core 0 and core 1. 0b10 Three cores, cores 0 to 2. 0b11 Four cores, cores 0 to 3. These bits are read-only and the value of this field is set to the number of cores present in the configuration.
[23]	-	Reserved, RES0.
[22]	CPU Cache Protection	CPU Cache Protection. Core RAMs are implemented: 0 Without ECC. 1 With ECC.
[21]	SCU-L2 Cache Protection	SCU-L2 Cache Protection. L2 cache is implemented: 0 Without ECC. 1 With ECC. This field is RO.
[20:6]	-	Reserved, RES0.
[5]	L2 data RAM input latency	L2 data RAM input latency: 0 1-cycle input delay from L2 data RAMs. 1 2-cycle input delay from L2 data RAMs. This field is RO.
[4:1]	-	Reserved, RES0.
[0]	L2 data RAM output latency	L2 data RAM output latency: 0 2-cycle output delay from L2 data RAMs. 1 3-cycle output delay from L2 data RAMs. This field is RO.

To access the L2CTLR_EL1:

```
MRS <Xt>, S3_1_C11_C0_2 ; Read L2CTLR_EL1 into Xt
MSR S3_1_C11_C0_2, <Xt>; Write Xt to L2CTLR_EL1
```

4.3.65 L2 Extended Control Register

The L2ECTLR_EL1 characteristics are:

Purpose Provides additional IMPLEMENTATION DEFINED control options for the L2 memory system. This register is used for dynamically changing, but implementation specific, control bits.

Table 4-100 shows the L2ECTLR_EL1 bit assignments.

Table 4-100 L2ECTLR_EL1 bit assignments

Bits	Name	Function
[31]	-	Reserved, RES0.
[30]	L2 internal asynchronous error	L2 internal asynchronous error caused by L2 RAM double-bit ECC error. The possible values are: 0 No pending asynchronous error. This is the reset value. 1 An asynchronous error has occurred. A write of 0 clears this bit and drives nINTERRIRQ HIGH. A write of 1 is ignored.
[29]	AXI or CHI asynchronous error	AXI or CHI asynchronous error indication. The possible values are: 0 No pending asynchronous error. 1 An asynchronous error has occurred. A write of 0 clears this bit and drives nEXTERRIRQ HIGH. A write of 1 is ignored.
[28:3]	-	Reserved, RES0.
[2:0]	L2 dynamic retention control	L2 dynamic retention control. The possible values are: 0b000 L2 dynamic retention disabled. This is the reset value. 0b001 2 Generic Timer ticks required before retention entry. 0b010 8 Generic Timer ticks required before retention entry. 0b011 32 Generic Timer ticks required before retention entry. 0b100 64 Generic Timer ticks required before retention entry. 0b101 128 Generic Timer ticks required before retention entry. 0b110 256 Generic Timer ticks required before retention entry. 0b111 512 Generic Timer ticks required before retention entry.

To access the L2ECTLR_EL1:

MRS Rt, S3_1_C11_C0_3; Read L2ECTLR_EL1 into Rt
 MSR S3_1_C11_C0_3, Rt; Write Rt to L2ECTLR_EL1

4.3.66 L2 Auxiliary Control Register

The L2ACTLR_EL1 characteristics are:

Purpose Provides configuration and control options for the L2 memory system.

Usage constraints This register is accessible as follows:

EL0	EL1 (NS)	EL1 (S)	EL2	EL3 (SCR.NS = 1)	EL3 (SCR.NS = 0)
-	RW	RW	RW	RW	RW

The L2ACTLR_EL1:

- This register can be written only when the L2 memory system is idle. ARM recommends that you write to this register after a powerup reset before the MMU is enabled and before any ACE, CHI or ACP traffic has begun.

If the register must be modified after a powerup reset sequence, to idle the L2 memory system, you must take the following steps:

1. Disable the MMU from each core followed by an ISB to ensure the MMU disable operation is complete, then followed by a DSB to drain previous memory transactions.
2. Ensure that the system has no outstanding AC channel coherence requests to the Cortex-A53 processor.
3. Ensure that the system has no outstanding ACP requests to the Cortex-A53 processor.

When the L2 memory system is idle, the processor can update the L2ACTLR_EL1 followed by an ISB. After the L2ACTLR_EL1 is updated, the MMUs can be enabled and normal ACE and ACP traffic can resume.

Configurations There is one copy of this register that is used in both Secure and Non-secure states.

L2ACTLR_EL1 is mapped to the AArch32 L2ACTLR register. See [L2 Auxiliary Control Register](#) on page 4-267.

Attributes L2ACTLR_EL1 is a 32 bit register.

[Figure 4-60](#) shows the L2ACTLR_EL1 bit assignments.

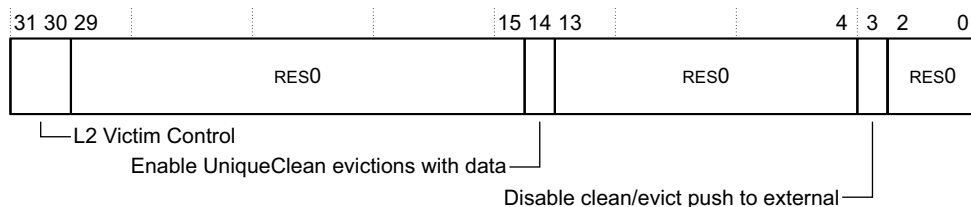

Figure 4-60 L2ACTLR_EL1 bit assignments

Table 4-101 shows the L2ACTLR_EL1 bit assignments.

Table 4-101 L2ACTLR_EL1 bit assignments

Bits	Name	Function
[31:30]	-	L2 victim Control. 0b10 This is the default value. Software must not change it.
[29:15]	-	Reserved, RES0.
[14]	Enable UniqueClean evictions with data	Enables sending of WriteEvict transactions for UniqueClean evictions with data. WriteEvict transactions update downstream caches that are outside the cluster. Enable WriteEvict transactions only if there is an L3 or system cache implemented in the system. The possible values are: 0 Disables UniqueClean evictions with data. This is the reset value for ACE. 1 Enables UniqueClean evictions with data. This is the reset value for CHI.
<p>Note</p> <p>Some ACE interconnects might not support the WriteEvict transaction. You must not enable this bit if your interconnect does not support WriteEvict transactions.</p>		
[13:4]	-	Reserved, RES0.
[3]	Disable clean/evict push to external	Disables sending of Evict transactions for clean cache lines that are evicted from the processor. This is required only if the external interconnect contains a snoop filter that requires notification when the processor evicts the cache line. The possible values are: 0 Enables clean/evict to be pushed out to external. This is the reset value for ACE. 1 Disables clean/evict from being pushed to external. This is the reset value for CHI.
[2:0]	-	Reserved, RES0.

To access the L2ACTLR_EL1:

MRS Rt, S3_1_C15_C0_0; Read L2ACTLR_EL1 into Rt
MSR S3_1_C15_C0_0, Rt; Write Rt to L2ACTLR_EL1

4.3.67 Fault Address Register, EL3

The FAR_EL3 characteristics are:

Purpose Holds the faulting Virtual Address for all synchronous instruction or data aborts, or exceptions from a misaligned PC, taken to EL3.

Usage constraints This register is accessible as follows:

EL0	EL1 (NS)	EL1 (S)	EL2	EL3 (SCR.NS = 1)	EL3 (SCR.NS = 0)
-	-	-	-	RW	RW

Configurations There is no additional configuration data for FAR_EL3.

Attributes FAR_EL3 is a 64-bit register.

Figure 4-61 on page 4-112 shows the FAR_EL3 bit assignments.

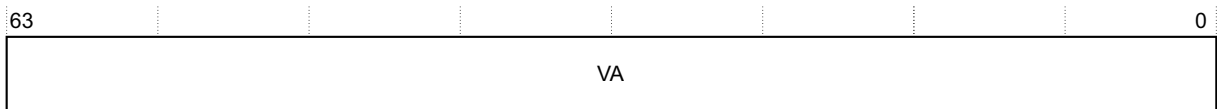

Figure 4-61 FAR_EL3 bit assignments

Table 4-102 shows the FAR_EL3 bit assignments.

Table 4-102 FAR_EL3 bit assignments

Bits	Name	Function
[63:0]	VA	The faulting Virtual Address for all synchronous instruction or data aborts, or an exception from a misaligned PC, taken in EL3. If a memory fault that sets the FAR is generated from one of the data cache instructions, this field holds the address specified in the register argument of the instruction.

To access the FAR_EL3:

MRS <Xt>, FAR_EL3 ; Read EL3 Fault Address Register
MSR FAR_EL3, <Xt> ; Write EL3 Fault Address Register

4.3.68 Physical Address Register, EL1

The PAR_EL1 characteristics are:

Purpose The Physical Address returned from an address translation.

Usage constraints This register is accessible as follows:

EL0	EL1 (NS)	EL1 (S)	EL2	EL3 (SCR.NS = 1)	EL3 (SCR.NS = 0)
-	RW	RW	RW	RW	RW

Configurations PAR_EL1 is architecturally mapped to AArch32 register PAR(NS). See *Physical Address Register* on page 4-251.

Attributes PAR_EL1 is a 64-bit register.

Figure 4-62 shows the PAR_EL1 bit assignments when the Virtual Address to Physical Address conversion completes successfully.

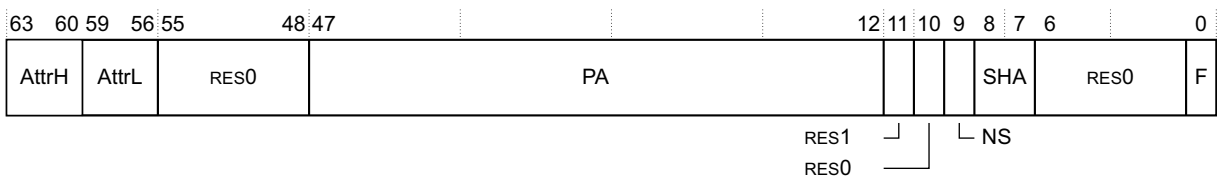

Figure 4-62 PAR_EL1 pass bit assignments

[Table 4-103 on page 4-114](#) shows the PAR_EL1 bit assignments when the Virtual Address to Physical Address conversion completes successfully.

Table 4-103 PAR_EL1 pass bit assignments

Bits	Name	Function
[63:60]	AttrH	<p>Defines Normal or Device memory and outer cacheability. Must be used in conjunction with AttrL. The possible values are:</p> <p>0b0000 Device memory, see Attr[3:0].</p> <p>0b0100 Normal memory, Outer Non-cacheable.</p> <p>0b1000 Normal memory, Outer Write-Through Cacheable.</p> <p>0b1001 Normal memory, Outer Write-Through Cacheable, Outer Write-Allocate.</p> <p>0b1010 Normal memory, Outer Write-Through Cacheable, Outer Read-Allocate.</p> <p>0b1011 Normal memory, Outer Write-Through Cacheable, Outer WriteAllocate, Outer Read-Allocate.</p> <p>0b1100 Normal memory, Outer Write-Back Cacheable.</p> <p>0b1101 Normal memory, Outer Write-Back Cacheable, Outer Write-Allocate.</p> <p>0b1110 Normal memory, Outer Write-Back Cacheable, Outer Read-Allocate.</p> <p>0b1111 Normal memory, Outer Write-Back Cacheable, Outer Write-Allocate, Outer Read-Allocate.</p> <p>All other values are reserved.</p>
[59:56]	AttrL	<p>Defines Device memory, and Inner cacheability. Must be interpreted in conjunction with AttrH. The possible values are:</p> <p>0b0000 Device (nGnRnE) memory if AttrH is 0b0000. Otherwise this value is reserved.</p> <p>0b0100 Device (not nGnRnE) memory if AttrH is 0b0000. Otherwise, Normal memory, Inner Non-cacheable.</p> <p>0b1000 Reserved if AttrH is 0b0000. Otherwise, Normal memory, Inner Write-Through Cacheable.</p> <p>0b1001 Reserved if AttrH is 0b0000. Otherwise, Normal memory, Inner Write-Through Cacheable, Inner Write-Allocate.</p> <p>0b1010 Reserved if AttrH is 0b0000. Otherwise, Normal memory, Inner Write-Through Cacheable, Inner Read-Allocate.</p> <p>0b1011 Reserved if AttrH is 0b0000. Otherwise, Normal memory, Inner Write-Through Cacheable, Inner Write-Allocate, Inner Read-Allocate.</p> <p>0b1100 Reserved if AttrH is 0b0000. Otherwise, Normal memory, Inner Write-Back Cacheable.</p> <p>0b1101 Reserved if AttrH is 0b0000. Otherwise, Normal memory, Inner Write-Back Cacheable, Inner Write-Allocate.</p> <p>0b1110 Reserved if AttrH is 0b0000. Otherwise, Normal memory, Inner Write-Back Cacheable, Inner Read-Allocate.</p> <p>0b1111 Reserved if AttrH is 0b0000. Otherwise, Normal memory, Inner Write-Through Cacheable, Inner Write-Allocate, Inner Read-Allocate.</p> <p>All other values are reserved.</p>
[55:48]	-	Reserved, RES0.
[47:12]	PA	Physical address. The Physical Address corresponding to the supplied Virtual Address. Returns address bits[47:12].
[11]	-	Reserved, RES1.
[10]	-	Reserved, RES0.
[9]	NS	Non-secure. The NS attribute for a translation table entry read from Secure state. This bit is UNKNOWN for a translation table entry from Non-secure state.

Table 4-103 PAR_EL1 pass bit assignments (continued)

Bits	Name	Function
[8:7]	SHA	Shareability attribute for the Physical Address returned from a translation table entry. The Possible values are: 0b00 Non-shareable. 0b01 Reserved. 0b10 Outer Shareable 0b11 Inner Shareable.
Note Takes the value of 0b10 for: <ul style="list-style-type: none"> Any type of device memory. Normal memory with both Inner Non-cacheable and Outer-cacheable attributes. 		
[6:1]	-	Reserved, RES0.
[0]	F	Pass/Fail bit. Indicates whether the conversion completed successfully. This value is: 0 Virtual Address to Physical Address conversion completed successfully.

Figure 4-63 shows the PAR_EL1 bit assignments when the Virtual Address to Physical Address conversion is aborted.

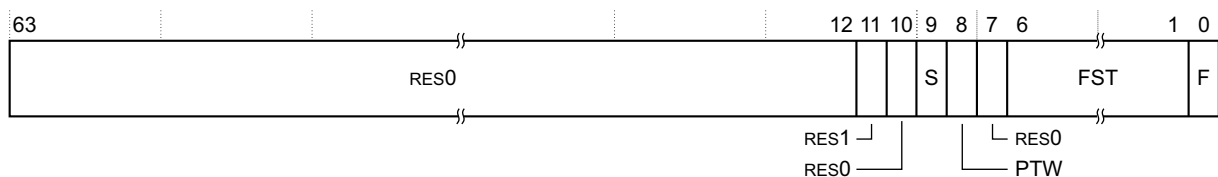

Figure 4-63 PAR_EL1 fail bit assignments

Table 4-104 shows the PAR_EL1 bit assignments when the Virtual Address to Physical Address conversion is aborted.

Table 4-104 PAR_EL1 fail bit assignments

Bits	Name	Function
[63:12]	-	Reserved, RES0.
[11]	-	Reserved, RES1.
[10]	-	Reserved, RES0.
[9]	S	Stage of fault. Indicates the state where the translation aborted. The possible values are: 0 Translation aborted because of a fault in stage 1 translation. 1 Translation aborted because of a fault in stage 2 translation.
[8]	PTW	Indicates a stage 2 fault during a stage 1 table walk. The possible values are: 0 No stage 2 fault during a stage 1 table walk. 1 Translation aborted because of a stage 2 fault during a stage 1 table walk.
[7]	-	Reserved, RES0.
[6:1]	FST	Fault status code, as shown in the Data Abort ESR encoding. See the <i>ARM® Architecture Reference Manual ARMv8, for ARMv8-A architecture profile</i> for more information.
[0]	F	Pass/Fail bit. Indicates whether the conversion completed successfully. This value is: 1 Virtual Address to Physical Address conversion aborted.

To access the PAR_EL1:

MRS <Xt>, PAR_EL1 ; Read EL1 Physical Address Register
MSR PAR_EL1, <Xt> ; Write EL1 Physical Address Register

4.3.69 Memory Attribute Indirection Register, EL1

The MAIR_EL1 characteristics are:

Purpose Provides the memory attribute encodings corresponding to the possible AttrIdx values in a Long-descriptor format translation table entry for stage 1 translations at EL1.

Usage constraints This register is accessible as follows:

EL0	EL1 (NS)	EL1 (S)	EL2	EL3 (SCR.NS = 1)	EL3 (SCR.NS = 0)
-	RW	RW	RW	RW	RW

MAIR_EL1 is permitted to be cached in a TLB.

Configurations MAIR_EL1[31:0] is architecturally mapped to AArch32 register:

- PRRR (NS) when TTBCR.EAE is 0. See [Primary Region Remap Register on page 4-256](#).
- MAIR0 (NS) when TTBCR.EAE is 1. See [Memory Attribute Indirection Registers 0 and 1 on page 4-259](#).

MAIR_EL1[63:32] is architecturally mapped to AArch32 register:

- NMRR (NS) when TTBCR.EAE is 0. See *Normal Memory Remap Register* on page 4-262.
- MAIR1(NS) when TTBCR.EAE is 1. See *Memory Attribute Indirection Registers 0 and 1* on page 4-259.

Attributes MAIR_EL1 is a 64-bit register.

Figure 4-64 shows the MAIR_EL1 bit assignments.

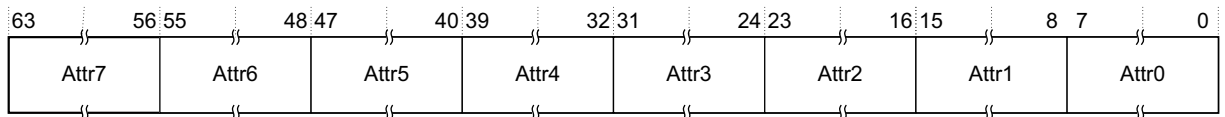

Figure 4-64 MAIR_EL1 bit assignments

Attr<n> is the memory attribute encoding for an AttrIdx[2:0] entry in a Long descriptor format translation table entry, where AttrIdx[2:0] gives the value of <n> in Attr<n>.

Table 4-105 shows the encoding of bits [7:4] of the Attr<n> field.

Table 4-105 Attr<n>[7:4] bit assignments

Bits	Meaning
0b0000	Device memory. See Table 4-106 for the type of Device memory.
0b00RW, RW not 00	Normal Memory, Outer Write-through transient. ^a
0b0100	Normal Memory, Outer Non-Cacheable.
0b01RW, RW not 00	Normal Memory, Outer Write-back transient. ^a
0b10RW	Normal Memory, Outer Write-through non-transient.
0b11RW	Normal Memory, Outer Write-back non-transient.

a. The transient hint is ignored.

Table 4-106 shows the encoding of bits [0:3] of the Attr<n> field.

Table 4-106 Attr<n>[3:0] bit assignments

Bits	Meaning when Attr<n>[7:4] is 0000	Meaning when Attr<n>[7:4] is not 0000
0b0000	Device-nGnRnE memory	UNPREDICTABLE
0b00RW, RW not 00	UNPREDICTABLE	Normal Memory, Inner Write-through transient
0b0100	Device-nGnRE memory	Normal memory, Inner Non-Cacheable
0b01RW, RW not 00	UNPREDICTABLE	Normal Memory, Inner Write-back transient
0b1000	Device-nGRE memory	Normal Memory, Inner Write-through non-transient (RW=00)
0b10RW, RW not 00	UNPREDICTABLE	Normal Memory, Inner Write-through non-transient
0b1100	Device-GRE memory	Normal Memory, Inner Write-back non-transient (RW=00)
0b11RW, RW not 00	UNPREDICTABLE	Normal Memory, Inner Write-back non-transient

Table 4-107 shows the encoding of the R and W bits that are used, in some Attr<n> encodings in Table 4-105 on page 4-117 and Table 4-106 on page 4-117, to define the read-allocate and write-allocate policies:

Table 4-107 Encoding of R and W bits in some Attrm fields

R or W	Meaning
0	Do not allocate
1	Allocate

To access the MAIR_EL1:

MRS <Xt>, MAIR_EL1 ; Read EL1 Memory Attribute Indirection Register

MSR MAIR_EL1, <Xt> ; Write EL1 Memory Attribute Indirection Register

4.3.70 Memory Attribute Indirection Register, EL2

The MAIR_EL2 characteristics are:

Purpose Provides the memory attribute encodings corresponding to the possible AttrIdx values in a Long-descriptor format translation table entry for stage 1 translations at EL2.

Usage constraints This register is accessible as follows:

EL0	EL1 (NS)	EL1 (S)	EL2	EL3 (SCR.NS = 1)	EL3 (SCR.NS = 0)
-	-	-	RW	RW	RW

MAIR_EL2 is permitted to be cached in a TLB.

Configurations MAIR_EL2[31:0] is architecturally mapped to AArch32 register HMAIR0.
MAIR_EL2[63:32] is architecturally mapped to AArch32 register HMAIR1.

Attributes MAIR_EL2 is a 64-bit register.

The MAIR_EL2 bit assignments follow the same pattern as described in Figure 4-64 on page 4-117.

The description of the MAIR_EL2 bit assignments are the same as described in Table 4-105 on page 4-117 and Table 4-108 on page 4-120.

To access the MAIR_EL2:

MRS <Xt>, MAIR_EL2 ; Read EL2 Memory Attribute Indirection Register

MSR MAIR_EL2, <Xt> ; Write EL2 Memory Attribute Indirection Register

4.3.71 Memory Attribute Indirection Register, EL3

The MAIR_EL3 characteristics are:

Purpose Provides the memory attribute encodings corresponding to the possible AttrIdx values in a Long-descriptor format translation table entry for stage 1 translations at EL3.

Usage constraints This register is accessible as follows:

EL0	EL1 (NS)	EL1 (S)	EL2	EL3 (SCR.NS = 1)	EL3 (SCR.NS = 0)
-	-	-	-	RW	RW

MAIR_EL2 is permitted to be cached in a TLB.

Configurations MAIR_EL3[31:0] is mapped to AArch32 register PRRR (S) when TTBCR.EAE is 0. See [Primary Region Remap Register on page 4-256](#).

MAIR_EL3[63:32] is mapped to AArch32 register NMRR (S) when TTBCR.EAE is 0. See [Normal Memory Remap Register on page 4-262](#).

Attributes MAIR_EL3 is a 64-bit register.

The MAIR_EL3 bit assignments follow the same pattern as described in [Figure 4-64 on page 4-117](#).

The description of the MAIR_EL3 bit assignments are the same as described in [Table 4-105 on page 4-117](#) and [Table 4-108 on page 4-120](#).

To access the MAIR_EL3:

MRS <Xt>, MAIR_EL3 ; Read EL3 Memory Attribute Indirection Register
MSR MAIR_EL3, <Xt> ; Write EL3 Memory Attribute Indirection Register

4.3.72 Vector Base Address Register, EL1

The VBAR_EL1 characteristics are:

Purpose Holds the exception base address for any exception that is taken to EL1.

Usage constraints This register is accessible as follows:

EL0	EL1 (NS)	EL1 (S)	EL2	EL3 (SCR.NS = 1)	EL3 (SCR.NS = 0)
-	RW	RW	RW	RW	RW

Configurations The VBAR_EL1[31:0] is architecturally mapped to the Non-secure AArch32 VBAR register. See [Vector Base Address Register on page 4-263](#).

Attributes VBAR_EL1 is a 64-bit register.

[Figure 4-65](#) shows the VBAR_EL1 bit assignments.

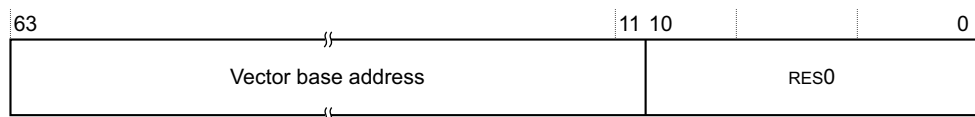

Figure 4-65 VBAR_EL1 bit assignments

Table 4-108 shows the VBAR_EL1 bit assignments.

Table 4-108 VBAR_EL1 bit assignments

Bits	Name	Function
[63:11]	Vector base address	Base address of the exception vectors for exceptions taken in this exception level.
[10:0]	-	Reserved, RES0.

To access the VBAR_EL1:

MRS <Xt>, VBAR_EL1 ; Read VBAR_EL1 into Xt
MSR VBAR_EL1, <Xt> ; Write Xt to VBAR_EL1

4.3.73 Vector Base Address Register, EL2

The VBAR_EL2 characteristics are:

Purpose Holds the exception base address for any exception that is taken to EL2.

Usage constraints This register is accessible as follows:

EL0	EL1 (NS)	EL1 (S)	EL2	EL3 (SCR.NS = 1)	EL3 (SCR.NS = 0)
-	-	-	RW	RW	RW

Configurations The VBAR_EL2[31:0] is architecturally mapped to the AArch32 HVBAR register. See [Hyp Vector Base Address Register on page 4-266](#).

Attributes VBAR_EL2 is a 64-bit register.

Figure 4-66 shows the VBAR_EL2 bit assignments.

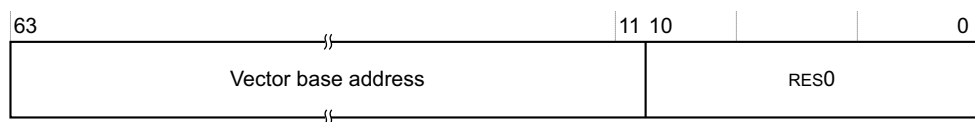

Figure 4-66 VBAR_EL2 bit assignments

Table 4-109 shows the VBAR_EL2 bit assignments.

Table 4-109 VBAR_EL2 bit assignments

Bits	Name	Function
[63:11]	Vector base address	Base address of the exception vectors for exceptions taken in this exception level.
[10:0]	-	Reserved, RES0.

To access the VBAR_EL2:

MRS <Xt>, VBAR_EL2 ; Read VBAR_EL2 into Xt
MSR VBAR_EL2, <Xt> ; Write Xt to VBAR_EL2

Register access is encoded as follows:

Table 4-110 VBAR_EL2 access encoding

op0	op1	CRn	CRm	op2
11	100	1100	0000	000

4.3.74 Vector Base Address Register, EL3

The VBAR_EL3 characteristics are:

Purpose Holds the exception base address for any exception that is taken to EL3.

Usage constraints This register is accessible as follows:

EL0	EL1 (NS)	EL1 (S)	EL2	EL3 (SCR.NS = 1)	EL3 (SCR.NS = 0)
-	-	-	-	RW	RW

Configurations The VBAR_EL3[31:0] is mapped to the Secure AArch32 VBAR register. See [Vector Base Address Register on page 4-263](#).

Attributes VBAR_EL3 is a 64-bit register.

[Figure 4-67](#) shows the VBAR_EL3 bit assignments.

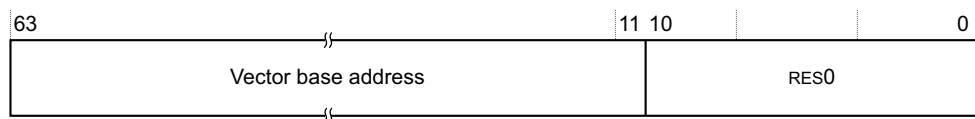

Figure 4-67 VBAR_EL3 bit assignments

[Table 4-111](#) shows the VBAR_EL3 bit assignments.

Table 4-111 VBAR_EL3 bit assignments

Bits	Name	Function
[63:11]	Vector base address	Base address of the exception vectors for exceptions taken in this exception level.
[10:0]	-	Reserved, RES0.

To access the VBAR_EL3:

MRS <Xt>, VBAR_EL3 ; Read EL3 Vector Base Address Register

MSR VBAR_EL3, <Xt> ; Write EL3 Vector Base Address Register

4.3.75 Reset Vector Base Address Register, EL3

The RVBAR_EL3 characteristics are:

Purpose Contains the address that execution starts from after reset when executing in the AArch64 state.

RVBAR_EL3 is part of the Reset management registers functional group.

Usage constraints This register is accessible as follows:

EL0	EL1 (NS)	EL1 (S)	EL2	EL3 (SCR.NS = 1)	EL3 (SCR.NS = 0)
-	-	-	-	RO	RO

Configurations There is no configuration information.

Attributes RVBAR_EL3 is a 64-bit register.

Figure 4-68 shows the RVBAR_EL3 bit assignments.

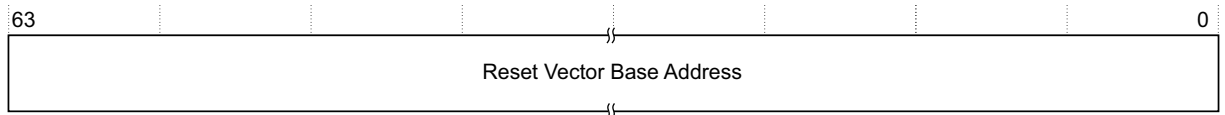

Figure 4-68 RVBAR_EL3 bit assignments

Table 4-112 shows the RVBAR_EL3 bit assignments.

Table 4-112 RVBAR_EL3 bit assignments

Bits	Name	Function
[63:0]	RVBA	Reset Vector Base Address. The address that execution starts from after reset when executing in 64-bit state. Bits[1:0] of this register are 0b00, as this address must be aligned, and bits [63:40] are 0x000000 because the address must be within the physical address size supported by the processor.

To access the RVBAR_EL3:

MRS <Xt>, RVBAR_EL3 ; Read RVBAR_EL3 into Xt

4.3.76 Reset Management Register

The RMR_EL3 characteristics are:

Purpose Controls the execution state that the processor boots into and allows request of a warm reset.

Usage constraints This register is accessible as follows:

EL0	EL1 (NS)	EL1 (S)	EL2	EL3 (SCR.NS = 1)	EL3 (SCR.NS = 0)
-	-	-	-	RW	RW

Configurations The RMR_EL3 is architecturally mapped to the AArch32 RMR register.

Attributes RMR_EL3 is a 32-bit register.

Figure 4-69 on page 4-123 shows the RMR_EL3 bit assignments.

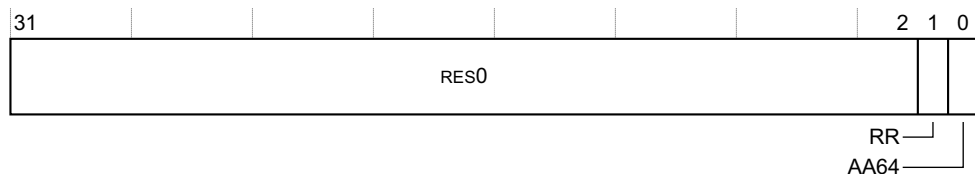

Figure 4-69 RMR_EL3 bit assignments

Table 4-113 shows the RMR_EL3 bit assignments.

Table 4-113 RMR_EL3 bit assignments

Bits	Name	Function
[31:2]	-	Reserved, RES0.
[1]	RR	Reset Request. The possible values are: 0 This is the reset value. 1 Requests a warm reset. This bit is set to 0 by either a cold or warm reset. The bit is strictly a request.
[0]	AA64 ^a	Determines which execution state the processor boots into after a warm reset. The possible values are: 0 AArch32 Execution state. 1 AArch64 Execution state. The reset vector address on reset takes a choice between two values, depending on the value in the AA64 bit. This ensures that even with reprogramming of the AA64 bit, it is not possible to change the reset vector to go to a different location.

a. The cold reset value depends on the **AA64nAA32** signal.

To access the RMR_EL3:

MRS <Xt>, RMR_EL3 ; Read RMR_EL3 into Xt
MSR RMR_EL3, <Xt> ; Write Xt to RMR_EL3

4.3.77 Interrupt Status Register

The ISR_EL1 characteristics are:

Purpose Shows whether an IRQ, FIQ, or external abort is pending. An indicated pending abort might be a physical abort or a virtual abort.

Usage constraints This register is accessible as follows:

EL0	EL1 (NS)	EL1 (S)	EL2	EL3 (SCR.NS = 1)	EL3 (SCR.NS = 0)
-	RO	RO	RO	RO	RO

Configurations ISR_EL1 is architecturally mapped to AArch32 register ISR. See [Interrupt Status Register on page 4-265](#).

Attributes ISR_EL1 is a 32-bit register.

Figure 4-70 on page 4-124 shows the ISR_EL1 bit assignments.

The CPU Auxiliary Control Register can be written only when the system is idle. ARM recommends that you write to this register after a powerup reset, before the MMU is enabled, and before any ACE or ACP traffic begins.

Note

Setting many of these bits can cause significantly lower performance on your code. Therefore, it is suggested that you do not modify this register unless directed by ARM.

Configurations

CPUACTLR_EL1 is:

- Common to the Secure and Non-secure states.
- Mapped to the AArch32 CPUACTLR register. *CPU Auxiliary Control Register on page 4-269.*

Attributes

CPUACTLR_EL1 is a 64-bit register.

Figure 4-71 shows the CPUACTLR_EL1 bit assignments.

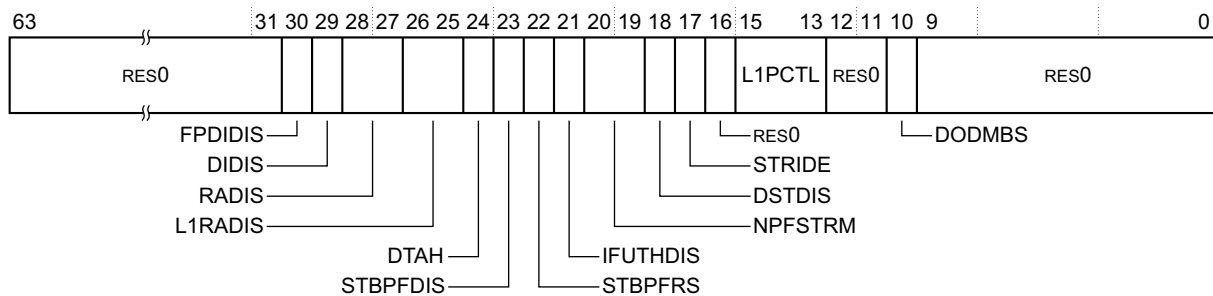

Figure 4-71 CPUACTLR_EL1 bit assignments

Table 4-116 shows the CPUACTLR_EL1 bit assignments.

Table 4-116 CPUACTLR_EL1 bit assignments

Bits	Name	Function
[63:31]	-	Reserved, RES0.
[30]	FPDIDIS	Disable floating-point dual issue. The possible values are: 0 Enable dual issue of floating-point, Advanced SIMD and Cryptography instructions. This is the reset value. 1 Disable dual issue of floating-point, Advanced SIMD and Cryptography instructions.
[29]	DIDIS	Disable Dual Issue. The possible values are: 0 Enable Dual Issue of instructions. This is the reset value. 1 Disable Dual Issue of all instructions.
[28:27]	RADIS	Write streaming no-allocate threshold. The possible values are: 0b00 16th consecutive streaming cache line does not allocate in the L1 or L2 cache. 0b01 128th consecutive streaming cache line does not allocate in the L1 or L2 cache. This is the reset value. 0b10 512th consecutive streaming cache line does not allocate in the L1 or L2 cache. 0b11 Disables streaming. All write-allocate lines allocate in the L1 or L2 cache.
[26:25]	L1RADIS	Write streaming no-L1-allocate threshold. The possible values are: 0b00 4th consecutive streaming cache line does not allocate in the L1 cache. This is the reset value. 0b01 64th consecutive streaming cache line does not allocate in the L1 cache. 0b10 128th consecutive streaming cache line does not allocate in the L1 cache. 0b11 Disables streaming. All write-allocate lines allocate in the L1 cache.
[24]	DTAH	Disable Transient allocation hint. The possible values are: 0 Normal operation. This is the reset value. 1 The Transient allocation hint in the MAIR is ignored and treated the same as non-transient allocation types. The LDNP and STNP instructions in AArch64 behave the same as the equivalent LDP and STP instructions.
[23]	STBPFERS	Disable ReadUnique request for prefetch streams initiated by STB accesses: 0 ReadUnique used for prefetch streams initiated from STB accesses. This is the reset value. 1 ReadShared used for prefetch streams initiated from STB accesses.

Table 4-116 CPUACTLR_EL1 bit assignments (continued)

Bits	Name	Function
[22]	STBPFDIS	Disable prefetch streams initiated from STB accesses: 0 Enable Prefetch streams initiated from STB accesses. This is the reset value. 1 Disable Prefetch streams initiated from STB accesses.
[21]	IFUTHDIS	IFU fetch throttle disabled. The possible values are: 0 Fetch throttle enabled. This is the reset value. 1 Fetch throttle disabled. This setting increases power consumption.
[20:19]	NPFSTRM	Number of independent data prefetch streams. The possible values are: 0b00 1 stream. 0b01 2 streams. This is the reset value. 0b10 3 streams. 0b11 4 streams.
[18]	DSTDIS	Enable device split throttle. The possible values are: 0 Device split throttle disabled. 1 Device split throttle enabled. This is the reset value.
[17]	STRIDE	Configure the sequence length that triggers data prefetch streams. The possible values are: 0 2 linefills to consecutive cache lines triggers prefetch. This is the reset value. 1 3 linefills to consecutive cache lines triggers prefetch. In both configurations, Three linefills with a fixed stride pattern are required to trigger prefetch, if the stride spans more than one cache line.
[16]	-	Reserved, RES0.
[15:13]	L1PCTL	L1 Data prefetch control. The value of the this field determines the maximum number of outstanding data prefetches allowed in the L1 memory system, excluding those generated by software load or PLD instructions. The possible values are: 0b000 Prefetch disabled. 0b001 1 outstanding prefetch allowed. 0b010 2 outstanding prefetches allowed. 0b011 3 outstanding prefetches allowed. 0b100 4 outstanding prefetches allowed. 0b101 5 outstanding prefetches allowed. This is the reset value. 0b110 6 outstanding prefetches allowed. 0b111 8 outstanding prefetches allowed.
[12:11]	-	Reserved, RES0.
[10]	DODMBS	Disable optimized Data Memory Barrier behavior. The possible values are: 0 Enable optimized Data Memory Barrier behavior. This is the reset value. 1 Disable optimized Data Memory Barrier behavior.
[9:0]	-	Reserved, RES0.

To access the CPUACTLR_EL1:

MRS <Xt>, S3_1_C15_C2_0 ; Read EL1 CPU Auxiliary Control Register
MSR S3_1_C15_C2_0, <Xt> ; Write EL1 CPU Auxiliary Control Register

4.3.79 CPU Extended Control Register, EL1

The CPUECTLR_EL1 characteristics are:

Purpose Provides additional IMPLEMENTATION DEFINED configuration and control options for the processor.

Usage constraints This register is accessible as follows:

EL0	EL1 (NS)	EL1 (S)	EL2	EL3 (SCR.NS = 1)	EL3 (SCR.NS = 0)
-	RW	RW	RW	RW	RW

The CPUECTLR_EL1 can be written dynamically.

The CPUECTLR_EL1 is write accessible in EL1 if ACTLR_EL3.CPUECTLR is 1 and ACTLR_EL2.CPUECTLR is 1, or ACTLR_EL3.CPUECTLR is 1 and SCR.NS is 0.

The CPUECTLR_EL1 is write accessible in EL2 if ACTLR_EL3.CPUECTLR is 1.

Configurations The CPUECTLR_EL1 is:

- Architecturally mapped to the AArch32 CPUECTLR register. See [CPU Extended Control Register on page 4-271](#).

Attributes CPUECTLR_EL1 is a 64-bit register.

Figure 4-72 shows the CPUECTLR_EL1 bit assignments.

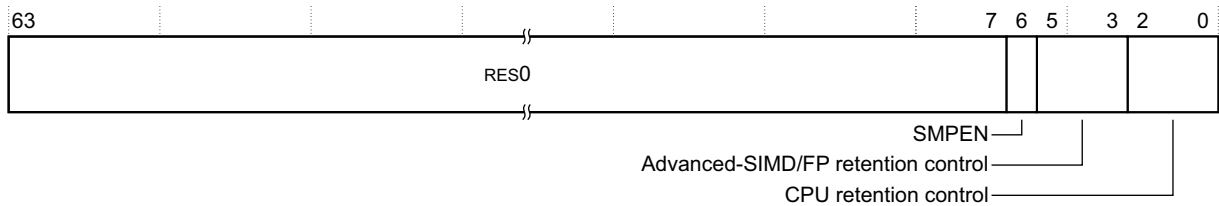

Figure 4-72 CPUECTLR_EL1 bit assignments

Table 4-117 shows the CPUECTLR_EL1 bit assignments.

Table 4-117 CPUECTLR_EL1 bit assignments

Bits	Name	Function
[63:7]	-	Reserved, RES0.
[6]	SMPEN	Enable hardware management of data coherency with other cores in the cluster. The possible values are: 0 Disables data coherency with other cores in the cluster. This is the reset value. 1 Enables data coherency with other cores in the cluster.
Note Set the SMPEN bit before enabling the caches, even if there is only one core in the system.		
[5:3]	-	Advanced SIMD and Floating-point retention control. The possible values are: 0b000 Disable the retention circuit. This is the reset value. 0b001 2 Architectural Timer ticks are required before retention entry. 0b010 8 Architectural Timer ticks are required before retention entry. 0b011 32 Architectural Timer ticks are required before retention entry. 0b100 64 Architectural Timer ticks are required before retention entry. 0b101 128 Architectural Timer ticks are required before retention entry. 0b110 256 Architectural Timer ticks are required before retention entry. 0b111 512 Architectural Timer ticks are required before retention entry.
Note This field is present only if the Advanced SIMD and Floating-point Extension is implemented. Otherwise, it is RES0.		
[2:0]	-	CPU retention control. The possible values are: 0b000 Disable the retention circuit. This is the reset value. 0b001 2 Architectural Timer ticks are required before retention entry. 0b010 8 Architectural Timer ticks are required before retention entry. 0b011 32 Architectural Timer ticks are required before retention entry. 0b100 64 Architectural Timer ticks are required before retention entry. 0b101 128 Architectural Timer ticks are required before retention entry. 0b110 256 Architectural Timer ticks are required before retention entry. 0b111 512 Architectural Timer ticks are required before retention entry.

To access the CPUECTLR_EL1:

MRS <Xt>, S3_1_C15_C2_1; Read EL1 CPU Extended Control Register
 MSR S3_1_C15_C2_1, <Xt>; Write EL1 CPU Extended Control Register

4.3.80 CPU Memory Error Syndrome Register

The CPUMERRSR_EL1 characteristics are:

Purpose Holds ECC errors on the:

- L1 data RAMs.
- L1 tag RAMs.
- L1 dirty RAMs.
- TLB RAMs.

This register is used for recording ECC errors on all processor RAMs.

Usage constraints This register is accessible as follows:

EL0	EL1 (NS)	EL1 (S)	EL2	EL3 (SCR.NS = 1)	EL3 (SCR.NS = 0)
-	RW	RW	RW	RW	RW

Configurations The CPUMERRSR_EL1 is:

- Architecturally mapped to the AArch64 CPUMERRSR register. See [CPU Memory Error Syndrome Register on page 4-273](#).
- There is one copy of this register that is used in both Secure and Non-secure states.
- A write of any value to the register updates the register to 0.

Attributes CPUMERRSR_EL1 is a 64-bit register.

Figure 4-143 on page 4-276 shows the CPUMERRSR_EL1 bit assignments.

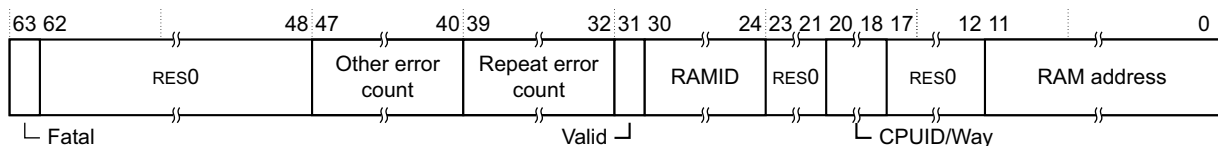

Figure 4-73 CPUMERRSR_EL1 bit assignments

Table 4-247 on page 4-277 shows the CPUMERRSR_EL1 bit assignments.

Table 4-118 CPUMERRSR_EL1 bit assignments

Bits	Name	Function																																																																														
[63]	Fatal	Fatal bit. This bit is set to 1 on the first memory error that caused a data abort. It is a sticky bit so that after it is set, it remains set until the register is written. The reset value is 0.																																																																														
[62:48]	-	Reserved, RES0.																																																																														
[47:40]	Other error count	This field is set to 0 on the first memory error and is incremented on any memory error that does not match the RAMID and Bank/Way information in this register while the sticky Valid bit is set. The reset value is 0.																																																																														
[39:32]	Repeat error count	This field is set to 0 on the first memory error and is incremented on any memory error that exactly matches the RAMID and Bank/Way information in this register while the sticky Valid bit is set. The reset value is 0.																																																																														
[31]	Valid	Valid bit. This bit is set to 1 on the first memory error. It is a sticky bit so that after it is set, it remains set until the register is written. The reset value is 0.																																																																														
[30:24]	RAMID	RAM Identifier. Indicates the RAM in which the first memory error. The possible values are: <table border="0"> <tr> <td>0x00</td> <td>L1 Instruction tag RAM.</td> </tr> <tr> <td>0x01</td> <td>L1 Instruction data RAM.</td> </tr> <tr> <td>0x08</td> <td>L1 Data tag RAM.</td> </tr> <tr> <td>0x09</td> <td>L1 Data data RAM.</td> </tr> <tr> <td>0x0A</td> <td>L1 Data dirty RAM.</td> </tr> <tr> <td>0x18</td> <td>TLB RAM.</td> </tr> </table>	0x00	L1 Instruction tag RAM.	0x01	L1 Instruction data RAM.	0x08	L1 Data tag RAM.	0x09	L1 Data data RAM.	0x0A	L1 Data dirty RAM.	0x18	TLB RAM.																																																																		
0x00	L1 Instruction tag RAM.																																																																															
0x01	L1 Instruction data RAM.																																																																															
0x08	L1 Data tag RAM.																																																																															
0x09	L1 Data data RAM.																																																																															
0x0A	L1 Data dirty RAM.																																																																															
0x18	TLB RAM.																																																																															
[23:21]	-	Reserved, RES0.																																																																														
[20:18]	CPUID/Way	Indicates the RAM where the first memory error occurred. <table border="0"> <tr> <td colspan="2">L1 I-tag RAM</td> <td colspan="2">L1 I-data RAM</td> <td colspan="2">TLB RAM</td> </tr> <tr> <td>0x0</td> <td>Way 0</td> <td>0x0</td> <td>Bank 0</td> <td>0x0</td> <td>Way 0</td> </tr> <tr> <td>0x1</td> <td>Way 1</td> <td>0x1</td> <td>Bank 1</td> <td>0x1</td> <td>Way 1</td> </tr> <tr> <td>0x2-0x7</td> <td>Unused</td> <td>0x2-0x7</td> <td>Unused</td> <td>0x2</td> <td>Way 2</td> </tr> <tr> <td></td> <td></td> <td></td> <td></td> <td>0x3</td> <td>Way 3</td> </tr> <tr> <td></td> <td></td> <td></td> <td></td> <td>0x4-0x7</td> <td>Unused</td> </tr> <tr> <td colspan="2">L1 D-dirty RAM</td> <td colspan="2">L1 D-tag RAM</td> <td colspan="2">L1 D-data RAM</td> </tr> <tr> <td>0x0</td> <td>Dirty RAM</td> <td>0x0</td> <td>Way 0</td> <td>0x0</td> <td>Bank 0</td> </tr> <tr> <td>0x1-0x7</td> <td>Unused</td> <td>0x1</td> <td>Way 1</td> <td>0x1</td> <td>Bank 1</td> </tr> <tr> <td></td> <td></td> <td>0x2</td> <td>Way 2</td> <td>0x2</td> <td>Bank 2</td> </tr> <tr> <td></td> <td></td> <td>0x3</td> <td>Way 3</td> <td>0x3</td> <td>Bank 3</td> </tr> <tr> <td></td> <td></td> <td>0x4-0x7</td> <td>Unused</td> <td>...</td> <td></td> </tr> <tr> <td></td> <td></td> <td></td> <td></td> <td>0x7</td> <td>Bank 7</td> </tr> </table>	L1 I-tag RAM		L1 I-data RAM		TLB RAM		0x0	Way 0	0x0	Bank 0	0x0	Way 0	0x1	Way 1	0x1	Bank 1	0x1	Way 1	0x2-0x7	Unused	0x2-0x7	Unused	0x2	Way 2					0x3	Way 3					0x4-0x7	Unused	L1 D-dirty RAM		L1 D-tag RAM		L1 D-data RAM		0x0	Dirty RAM	0x0	Way 0	0x0	Bank 0	0x1-0x7	Unused	0x1	Way 1	0x1	Bank 1			0x2	Way 2	0x2	Bank 2			0x3	Way 3	0x3	Bank 3			0x4-0x7	Unused	...						0x7	Bank 7
L1 I-tag RAM		L1 I-data RAM		TLB RAM																																																																												
0x0	Way 0	0x0	Bank 0	0x0	Way 0																																																																											
0x1	Way 1	0x1	Bank 1	0x1	Way 1																																																																											
0x2-0x7	Unused	0x2-0x7	Unused	0x2	Way 2																																																																											
				0x3	Way 3																																																																											
				0x4-0x7	Unused																																																																											
L1 D-dirty RAM		L1 D-tag RAM		L1 D-data RAM																																																																												
0x0	Dirty RAM	0x0	Way 0	0x0	Bank 0																																																																											
0x1-0x7	Unused	0x1	Way 1	0x1	Bank 1																																																																											
		0x2	Way 2	0x2	Bank 2																																																																											
		0x3	Way 3	0x3	Bank 3																																																																											
		0x4-0x7	Unused	...																																																																												
				0x7	Bank 7																																																																											
[17:12]		Reserved, RES0.																																																																														
[11:0]	RAM address	Indicates the index address of the first memory error.																																																																														

Note

- A fatal error results in the RAMID, Way, and RAM address recording the fatal error, even if the sticky bit is set.

- Only L1 Data data and L1 Data dirty RAMs can signal fatal errors, because all other RAM instances are protected only by parity.
- If two or more memory errors in the same RAM occur in the same cycle, only one error is reported.
- If two or more first memory error events from different RAMs occur in the same cycle, one of the errors is selected arbitrarily.
- If two or more memory error events from different RAMs, that do not match the RAMID, Way, and index information in this register while the sticky Valid bit is set, occur in the same cycle, then the Other error count field is incremented only by one.

To access the CPUMERRSR_EL1:

```
MRS <Xt>, S3_1_c15_c2_2 ; Read CPUMERRSR into Xt
MSR S3_1_c15_c2_2, <Xt> ; Write Xt to CPUMERRSR
```

4.3.81 L2 Memory Error Syndrome Register

The L2MERRSR_EL1 characteristics are:

Purpose Holds information about ECC errors on the:

- L2 data RAMs.
- L2 tag RAMs.
- SCU snoop filter RAMs.

Usage constraints This register is accessible as follows:

EL0	EL1 (NS)	EL1 (S)	EL2	EL3 (SCR.NS = 1)	EL3 (SCR.NS = 0)
-	RW	RW	RW	RW	RW

Configurations The L2MERRSR_EL1 is:

- Mapped to the AArch32 L2MERRSR register. See [L2 Memory Error Syndrome Register on page 4-276](#).
- There is one copy of this register that is used in both Secure and Non-secure states.
- A write of any value to the register updates the register to 0x10000000.

Attributes L2MERRSR_EL1 is a 64-bit register.

Figure 4-74 shows the L2MERRSR_EL1 bit assignments.

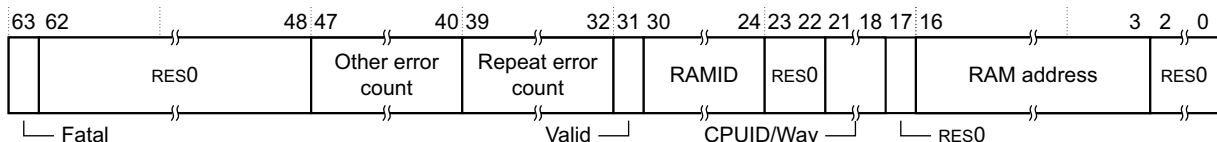

Figure 4-74 L2MERRSR_EL1 bit assignments

Table 4-119 shows the L2MERRSR_EL1 bit assignments.

Table 4-119 L2MERRSR_EL1 bit assignments

Bits	Name	Function																																				
[63]	Fatal	Fatal bit. This bit is set to 1 on the first memory error that caused a data abort. It is a sticky bit so that after it is set, it remains set until the register is written. The reset value is 0.																																				
[62:48]	-	Reserved, RES0.																																				
[47:40]	Other error count	This field is set to 0 on the first memory error and is incremented on any memory error that does not match the RAMID and Bank/Way information in this register while the sticky Valid bit is set. The reset value is 0.																																				
[39:32]	Repeat error count	This field is set to 0 on the first memory error and is incremented on any memory error that exactly matches the RAMID and Bank/Way information in this register while the sticky Valid bit is set. The reset value is 0.																																				
[31]	Valid	Valid bit. This bit is set to 1 on the first memory error. It is a sticky bit so that after it is set, it remains set until the register is written. The reset value is 0.																																				
[30:24]	RAMID	RAM Identifier. Indicates the RAM in which the first memory error occurred. The possible values are: 0x10 L2 tag RAM. 0x11 L2 data RAM. 0x12 SCU snoop filter RAM.																																				
[23:22]	-	Reserved, RES0.																																				
[21:18]	CPUID/Way	Indicates the RAM where the first memory error occurred. <table border="1"> <thead> <tr> <th colspan="2">L2 tag RAM</th> <th colspan="2">L2 data RAM</th> <th colspan="2">SCU snoop filter RAM</th> </tr> </thead> <tbody> <tr> <td>0x0</td> <td>Way 0</td> <td>0x0</td> <td>Bank 0</td> <td>0x0</td> <td>CPU0:Way0</td> </tr> <tr> <td>0x1</td> <td>Way 1</td> <td>0x1</td> <td>Bank 1</td> <td>0x1</td> <td>CPU0:Way1</td> </tr> <tr> <td>...</td> <td></td> <td>...</td> <td></td> <td>...</td> <td></td> </tr> <tr> <td>0xE</td> <td>Way 14</td> <td>0x7</td> <td>Bank 7</td> <td>0xE</td> <td>CPU3:Way2</td> </tr> <tr> <td>0xF</td> <td>Way 15</td> <td>0x8-0xF</td> <td>Unused</td> <td>0xF</td> <td>CPU3:Way3</td> </tr> </tbody> </table>	L2 tag RAM		L2 data RAM		SCU snoop filter RAM		0x0	Way 0	0x0	Bank 0	0x0	CPU0:Way0	0x1	Way 1	0x1	Bank 1	0x1	CPU0:Way1		0xE	Way 14	0x7	Bank 7	0xE	CPU3:Way2	0xF	Way 15	0x8-0xF	Unused	0xF	CPU3:Way3
L2 tag RAM		L2 data RAM		SCU snoop filter RAM																																		
0x0	Way 0	0x0	Bank 0	0x0	CPU0:Way0																																	
0x1	Way 1	0x1	Bank 1	0x1	CPU0:Way1																																	
...																																			
0xE	Way 14	0x7	Bank 7	0xE	CPU3:Way2																																	
0xF	Way 15	0x8-0xF	Unused	0xF	CPU3:Way3																																	
[17]	-	Reserved, RES0.																																				
[16:3]	Index	Indicates the index address of the first memory error.																																				
[2:0]	-	Reserved, RES0.																																				

———— **Note** —————

- A fatal error results in the RAMID, CPU ID/Way and RAM address recording the fatal error, even if the sticky bit was set.
- If two or more memory errors in the same RAM occur in the same cycle, only one error is reported.
- If two or more first memory error events from different RAMs occur in the same cycle, one of the errors is selected arbitrarily, while the Other error count field is incremented only by one.

- If two or more memory error events from different RAMs, that do not match the RAMID, bank, way, or index information in this register while the sticky Valid bit is set, occur in the same cycle, the Other error count field is incremented only by one.

To access the L2MERRSR_EL1:

MRS <Xt>, S3_1_C15_C2_3 ; Read L2MERRSR_EL1 into Xt
MSR S3_1_C15_C2_3, <Xt> ; Write Xt into L2MERRSR_EL1

4.3.82 Configuration Base Address Register, EL1

The CBAR_EL1 characteristics are:

Purpose Holds the physical base address of the memory-mapped GIC CPU interface registers.

Usage constraints This register is accessible as follows:

EL0	EL1 (NS)	EL1 (S)	EL2	EL3 (SCR.NS = 1)	EL3 (SCR.NS = 0)
-	RO	RO	RO	RO	RO

Configurations There is one copy of this register that is used in both Secure and Non-secure states.

Attributes CBAR_EL1 is a 64-bit register.

Figure 4-75 shows the CBAR_EL1 bit assignments.

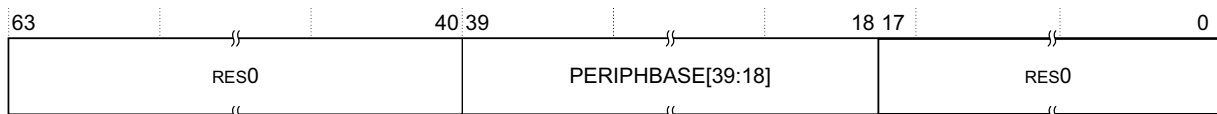

Figure 4-75 CBAR_EL1 bit assignments

Table 4-120 shows the CBAR_EL1 bit assignments.

Table 4-120 CBAR_EL1 bit assignments

Bits	Name	Function
[63:40]	-	Reserved, RES0.
[39:18]	PERIPHBASE[39:18]	The input PERIPHBASE[39:18] determines the reset value.
[17:0]	-	Reserved, RES0.

To access the CBAR_EL1:

MRS <Xt>, S3_1_C15_C3_0 ; Read CBAR_EL1 into Xt

4.4 AArch32 register summary

In AArch32 state you access the system registers through a conceptual coprocessor, identified as CP15, the System Control Coprocessor. Within CP15, there is a top-level grouping of system registers by a primary coprocessor register number, c0-c15. See the *ARM® Architecture Reference Manual ARMv8, for ARMv8-A architecture profile* for more information about using the conceptual System Control Coprocessor in a VMSA context.

The system register space includes System operations system registers and System operations. The description of the system register space describes the permitted access, RO, WO, or RW, to each register or operation.

The following sections describe the CP15 system control registers grouped by CRn order, and are accessed by the MCR and MRC instructions.

- [c0 registers on page 4-137.](#)
- [c1 registers on page 4-138.](#)
- [c2 registers on page 4-139.](#)
- [c3 registers on page 4-139.](#)
- [c4 registers on page 4-139.](#)
- [c5 registers on page 4-140.](#)
- [c6 registers on page 4-140.](#)
- [c7 registers on page 4-140.](#)
- [c9 registers on page 4-141.](#)
- [c10 registers on page 4-142.](#)
- [c11 registers on page 4-142.](#)
- [c12 registers on page 4-142.](#)
- [c13 registers on page 4-144.](#)
- [c14 registers on page 4-144.](#)
- [c15 registers on page 4-146.](#)

The following subsection describes the 64-bit registers and provides cross-references to individual register descriptions:

- [64-bit registers on page 4-147.](#)

In addition to listing the CP15 system registers by CRn ordering, the following subsections describe the CP15 system registers by functional group:

- [AArch32 Identification registers on page 4-148.](#)
- [AArch32 Virtual memory control registers on page 4-149.](#)
- [AArch32 Fault handling registers on page 4-150.](#)
- [AArch32 Other System control registers on page 4-150.](#)
- [AArch32 Address registers on page 4-150.](#)
- [AArch32 Thread registers on page 4-151.](#)
- [AArch32 Performance monitor registers on page 4-151.](#)
- [AArch32 Secure registers on page 4-152.](#)
- [AArch32 Virtualization registers on page 4-153.](#)
- [AArch32 GIC system registers on page 4-154.](#)
- [AArch32 Generic Timer registers on page 4-155.](#)
- [AArch32 Implementation defined registers on page 4-156.](#)

Table 4-121 describes the column headings in the CP15 register summary tables use throughout this section.

Table 4-121 System register field values

Heading	Description
CRn	System control primary register number.
Op1	Arguments to the register access instruction.
CRm	
Op2	
Name	The name of the register or operation. Some assemblers support aliases that you can use to access the registers and operations by name.
Reset	Reset value of register.
Description	Cross-reference to the register description.

4.4.1 c0 registers

Table 4-122 shows the 32-bit wide system registers you can access when the processor is in AArch32 state and the value of CRn is c0.

Table 4-122 c0 register summary

CRn	Op1	CRm	Op2	Name	Reset	Description
c0	0	c0	0	MIDR	0x410FD032	<i>Main ID Register on page 4-157</i>
			1	CTR	0x84448004	<i>Cache Type Register on page 4-188</i>
			2	TCMTR	0x00000000	<i>TCM Type Register on page 4-160</i>
			3	TLBTR	0x00000000	<i>TLB Type Register on page 4-160</i>
			4, 7	MIDR	0x410FD032	Aliases of Main ID Register, <i>Main ID Register on page 4-157</i>
			5	MPIDR	-a	<i>Multiprocessor Affinity Register on page 4-158</i>
c1	0	c1	0	ID_PFR0	0x00000131	<i>Processor Feature Register 0 on page 4-160</i>
			1	ID_PFR1	0x10011011 ^b	<i>Processor Feature Register 1 on page 4-162</i>
			2	ID_DFR0	0x03010066	<i>Debug Feature Register 0 on page 4-163</i>
			3	ID_AFR0	0x00000000	<i>Auxiliary Feature Register 0 on page 4-164</i>
			4	ID_MMFR0	0x10101105	<i>Memory Model Feature Register 0 on page 4-165</i>
			5	ID_MMFR1	0x40000000	<i>Memory Model Feature Register 1 on page 4-166</i>
			6	ID_MMFR2	0x01260000	<i>Memory Model Feature Register 2 on page 4-168</i>
c2	0	c2	0	ID_ISAR0	0x02101110	<i>Instruction Set Attribute Register 0 on page 4-172</i>
			1	ID_ISAR1	0x13112111	<i>Instruction Set Attribute Register 1 on page 4-173</i>
			2	ID_ISAR2	0x21232042	<i>Instruction Set Attribute Register 2 on page 4-175</i>
			3	ID_ISAR3	0x01112131	<i>Instruction Set Attribute Register 3 on page 4-178</i>
0	c2	0	4	ID_ISAR4	0x00011142	<i>Instruction Set Attribute Register 4 on page 4-179</i>
			5	ID_ISAR5	0x00011121 ^c	<i>Instruction Set Attribute Register 5 on page 4-181</i>
1	c0	0	0	CCSIDR	-	<i>Cache Size ID Register on page 4-183</i>
			1	CLIDR	0x0A200023 ^d	<i>Cache Level ID Register on page 4-185</i>
			7	AIDR	0x00000000	<i>Auxiliary ID Register on page 4-187</i>
2	c0	0	CSSELR	0x00000000	<i>Cache Size Selection Register on page 4-187</i>	
4	c0	0	0	VPIDR	0x410FD032	<i>Virtualization Processor ID Register on page 4-189</i>
			5	VMPIDR	-e	<i>Virtualization Multiprocessor ID Register on page 4-190</i>

- a. The reset value depends on the primary inputs, CLUSTERIDAFF1 and CLUSTERIDAFF2, and the number of cores that the device implements.
- b. Bits [31:28] are 0x1 if the GIC CPU interface is enabled, and 0x0 otherwise.
- c. ID_ISAR5 has the value 0x00010001 if the Cryptography Extension is not implemented and enabled.

- d. The value is 0x09200003 if the L2 cache is not implemented.
- e. The reset value is the value of the Multiprocessor Affinity Register.

4.4.2 c1 registers

Table 4-123 shows the 32-bit wide system registers you can access when the processor is in AArch32 state and the value of CRn is c1.

Table 4-123 c1 register summary

CRn	Op1	CRm	Op2	Name	Reset	Description			
c1	0	c0	0	SCTLR	0x00C50838 ^a	<i>System Control Register on page 4-191</i>			
			1	ACTLR	0x00000000	<i>Auxiliary Control Register on page 4-196</i>			
			2	CPACR	0x00000000	<i>Architectural Feature Access Control Register on page 4-197</i>			
	c1			0	SCR	0x00000000	<i>Secure Configuration Register on page 4-199</i>		
				1	SDER	0x00000000	<i>Secure Debug Enable Register on page 4-201</i>		
				2	NSACR	0x00000000 ^b	<i>Non-Secure Access Control Register on page 4-202</i>		
	c3			1	SDCR	0x00000000	<i>Secure Debug Control Register on page 4-204</i>		
				4	c0	0	HSCTLR	0x03C50838	<i>Hyp System Control Register on page 4-207</i>
						1	HACTLR	0x00000000	<i>Auxiliary Control Register, EL2 on page 4-55</i>
c1			0		HCR	0x00000000	<i>Hyp Configuration Register on page 4-211</i>		
			1	HDCR	0x00000006	<i>Hyp Debug Control Register on page 4-217</i>			
			2	HCPTR	0x000033FF ^c	<i>Hyp Architectural Feature Trap Register on page 4-221</i>			
			3	HSTR	0x00000000	<i>Hyp System Trap Register on page 4-236</i>			
			4	HCR2	0x00000000	<i>Hyp Configuration Register 2 on page 4-216</i>			
			7	HACR	0x00000000	<i>Hyp Architectural Feature Trap Register on page 4-221</i>			

- a. The reset value depends on inputs, **CFGTE**, **CFGEND**, and **VINITHI**. The value shown in Table 4-122 on page 4-137 assumes these signals are set to LOW.
- b. If EL3 is AArch64 then the NSACR reads as 0x0000C00.
- c. The reset value depends on the FPU and NEON configuration. If Advanced SIMD and Floating-point are implemented, the reset value is 0x000033FF. If Advanced SIMD and Floating-point are not implemented, the reset value is 0x0000BFFF.

4.4.3 c2 registers

Table 4-124 shows the 32-bit wide system registers you can access when the processor is in AArch32 state and the value of CRn is c2.

Table 4-124 c2 register summary

CRn	Op1	CRm	Op2	Name	Reset	Description
c2	0	c0	0	TTBR0	UNK	<i>Translation Table Base Register 0 on page 4-224</i>
			1	TTBR1	UNK	<i>Translation Table Base Register 1 on page 4-226</i>
			2	TTBCR	0x00000000 ^a	<i>Hyp Translation Control Register on page 4-232</i>
4		c0	2	HTCR	UNK	<i>Hyp Translation Control Register on page 4-232</i>
		c1	2	VTCR	UNK	<i>Virtualization Translation Control Register on page 4-233</i>

- a. The reset value is 0x00000000 for the Secure copy of the register. The reset value for the EAE bit of the Non-secure copy of the register is 0x0. You must program the Non-secure copy of the register with the required initial value, as part of the processor boot sequence.

4.4.4 c3 registers

Table 4-125 shows the 32-bit wide system registers you can access when the processor is in AArch32 state and the value of CRn is c3.

Table 4-125 c3 register summary

CRn	Op1	CRm	Op2	Name	Reset	Description
c3	0	c0	0	DACR	UNK	<i>Domain Access Control Register on page 4-235</i>

4.4.5 c4 registers

Table 4-126 shows the 32-bit wide system registers you can access when the processor is in AArch32 state and the value of CRn is c4.

Table 4-126 c3 register summary

CRn	Op1	CRm	Op2	Name	Reset	Description
c4	0	c6	0	ICC_PMR	0x00000000	Priority Mask Register

4.4.6 c5 registers

Table 4-127 shows the 32-bit wide system registers you can access when the processor is in AArch32 state and the value of CRn is c5.

Table 4-127 c5 register summary

CRn	Op1	CRm	Op2	Name	Reset	Description
c5	0	c0	0	DFSR	UNK	<i>Data Fault Status Register on page 4-239</i>
			1	IFSR	UNK	<i>Instruction Fault Status Register on page 4-243</i>
	c1	0	ADFSR	0x00000000	<i>Auxiliary Data Fault Status Register on page 4-246</i>	
		1	AIFSR	0x00000000	<i>Auxiliary Instruction Fault Status Register on page 4-246</i>	
c5	4	c1	0	HADFSR	0x00000000	<i>Hyp Auxiliary Data Fault Status Syndrome Register on page 4-246</i>
			1	HAIFSR	0x00000000	<i>Hyp Auxiliary Instruction Fault Status Syndrome Register on page 4-246</i>
		c2	0	HSR	UNK	<i>Hyp Syndrome Register on page 4-246</i>

4.4.7 c6 registers

Table 4-128 shows the 32-bit wide system registers you can access when the processor is in AArch32 state and the value of CRn is c6.

Table 4-128 c6 register summary

CRn	Op1	CRm	Op2	Name	Reset	Description
c6	0	c0	0	DFAR	UNK	<i>Data Fault Address Register on page 4-247</i>
			2	IFAR	UNK	<i>Instruction Fault Address Register on page 4-248</i>
	4	c0	0	HDFAR	UNK	<i>Hyp Data Fault Address Register on page 4-249</i>
			2	HIFAR	UNK	<i>Hyp Instruction Fault Address Register on page 4-250</i>
			4	HPFAR	UNK	<i>Hyp IPA Fault Address Register on page 4-250</i>

4.4.8 c7 registers

Table 4-129 shows the 32-bit wide system registers you can access when the processor is in AArch32 state and the value of CRn is c7. See the *ARM® Architecture Reference Manual ARMv8, for ARMv8-A architecture profile* for more information.

Table 4-129 c7 register summary

CRn	Op1	CRm	Op2	Name	Reset	Description
c7	0	c4	0	PAR	UNK	<i>Physical Address Register on page 4-251</i>

4.4.9 c9 registers

Table 4-130 shows the 32-bit wide system registers you can access when the processor is in AArch32 state and the value of CRn is c9. See the *ARM® Architecture Reference Manual ARMv8, for ARMv8-A architecture profile* for more information.

Table 4-130 c9 register summary

CRn	Op1	CRm	Op2	Name	Reset	Description	
c9	0	c12	0	PMCR	0x41033000	<i>Performance Monitors Control Register on page 12-16</i>	
			1	PMNCNTENSET	UNK	Performance Monitors Count Enable Set Register	
			2	PMNCNTENCLR	UNK	Performance Monitors Count Enable Clear Register	
			3	PMOVSr	UNK	Performance Monitor Overflow Flag Status Clear Register	
			4	PMSWINC	UNK	Performance Monitors Software Increment Register	
			5	PMSELR	UNK	Performance Monitors Event Counter Selection Register	
			6	PMCEID0	0x67FFBFFF ^a	<i>Performance Monitors Common Event Identification Register 0 on page 12-18</i>	
			7	PMCEID1	0x00000000	<i>Performance Monitors Common Event Identification Register 1 on page 12-21</i>	
		c13	0	PMCCNTR	UNK	Performance Monitors Cycle Counter	
			1	PMXEVTYPER	UNK	Performance Monitors Selected Event Type and Filter Register	
			2	PMXVCNTR	UNK	Performance Monitors Selected Event Counter Register	
		c14	0	0	PMUSERENR	0x00000000	Performance Monitors User Enable Register
				1	PMINTENSET	UNK	Performance Monitors Interrupt Enable Set Register
				2	PMINTENCLR	UNK	Performance Monitors Interrupt Enable Clear Register
3	PMOVSET			UNK	Performance Monitor Overflow Flag Status Set Register		
1	c0	2	L2CTLR	- ^b	<i>L2 Control Register on page 4-251</i>		
			L2ECTLR	0x00000000	<i>L2 Extended Control Register on page 4-253</i>		

a. The reset value is 0x663FBFFF if L2 cache is not implemented.

b. The reset value depends on the processor configuration.

4.4.10 c10 registers

Table 4-131 shows the 32-bit wide system registers you can access when the processor is in AArch32 state and the value of CRn is c10.

Table 4-131 c10 register summary

CRn	Op1	CRm	Op2	Name	Reset	Description
c10	0	c2	0	PRRR	UNK	<i>Primary Region Remap Register on page 4-256</i>
			0	MAIR0	UNK	<i>Memory Attribute Indirection Registers 0 and 1 on page 4-259</i>
			1	NMRR	UNK	<i>Normal Memory Remap Register on page 4-262</i>
			1	MAIR1	UNK	<i>Memory Attribute Indirection Registers 0 and 1 on page 4-259</i>
	c3	0	AMAIRO	0x00000000	<i>Auxiliary Memory Attribute Indirection Register 0 on page 4-263</i>	
		1	AMAIR1	0x00000000	<i>Auxiliary Memory Attribute Indirection Register 1 on page 4-263</i>	
	4	c2	0	HMAIRO	UNK	Hyp Memory Attribute Indirection Register 0 ^a
			1	HMAIR1	UNK	Hyp Memory Attribute Indirection Register 1 ^a
c3		0	HAMAIRO	0x00000000	<i>Hyp Auxiliary Memory Attribute Indirection Register 0 on page 4-263</i>	
		1	HAMAIR1	0x00000000	<i>Hyp Auxiliary Memory Attribute Indirection Register 1 on page 4-263</i>	

a. See the *ARM® Architecture Reference Manual ARMv8, for ARMv8-A architecture profile* for more information.

4.4.11 c11 registers

There are no system registers to access when the processor is in AArch32 state and the value of CRn is c11.

4.4.12 c12 registers

Table 4-132 shows the 32-bit wide system registers you can access when the processor is in AArch32 state and the value of CRn is c12.

Table 4-132 c12 register summary

CRn	Op1	CRm	Op2	Name	Reset	Description
c12	0	c0	0	VBAR	0x00000000	<i>Vector Base Address Register on page 4-263.</i>
			1	MVBAR	UNK	Monitor Vector Base Address Register. See the <i>ARM® Architecture Reference Manual ARMv8, for ARMv8-A architecture profile</i> for more information.
			2	RMR	0x00000000	<i>Reset Management Register on page 4-264.</i>
	c1	0	ISR	UNK	<i>Interrupt Status Register on page 4-265.</i>	
	c8	0	0	ICC_IAR0	-	Interrupt Acknowledge Register 0
			1	ICC_EOIR0	-	End Of Interrupt Register 0
			2	ICC_HPPIR0	-	Highest Priority Pending Interrupt Register 0
3			ICC_BPR0	0x00000002	Binary Point Register 0	
4	ICC_APOR0	0x00000000	Active Priorities 0 Register 0			

Table 4-132 c12 register summary (continued)

CRn	Op1	CRm	Op2	Name	Reset	Description			
c12	0	c9	0	ICC_APIR0	0x00000000	Active Priorities 1 Register 0			
			c11	1	ICC_DIR	-	Deactivate Interrupt Register		
				3	ICC_RPR	-	Running Priority Register		
		c12	0	ICC_IAR1	-	Interrupt Acknowledge Register 1			
			1	ICC_EOIR1	-	End Of Interrupt Register 1			
			2	ICC_HPPIR1	-	Highest Priority Pending Interrupt Register 1			
			3	ICC_BPR1	0x0000003 ^a	Binary Point Register 1			
			4	ICC_CTLR	0x00000400	Interrupt Control Register			
			5	ICC_SRE	0x00000000	System Register Enable Register			
			6	ICC_IGRPEN0	0x00000000	Interrupt Group Enable Register 0			
			7	ICC_IGRPEN1	0x00000000	Interrupt Group Enable Register 1			
		4	c0	0		HVBAR	UNK	<i>Hyp Vector Base Address Register on page 4-266.</i>	
					c8	0	ICH_AP0R0	0x00000000	Interrupt Controller Hyp Active Priorities Register (0,0)
					c9	0	ICH_APIR0	0x00000000	Interrupt Controller Hyp Active Priorities Register (1,0)
5	ICC_HSRE					0x00000000	System Register Enable Register for EL2		
c11	0				ICH_HCR	0x00000000	Interrupt Controller Hyp Control Register		
	1				ICH_VTR	0x90000003	Interrupt Controller VGIC Type Register		
	2				ICH_MISR	0x00000000	Interrupt Controller Maintenance Interrupt State Register		
	3				ICH_EISR	0x00000000	Interrupt Controller End of Interrupt Status Register		
	7				ICH_VMCR	0x004C0000	Interrupt Controller Virtual Machine Control Register		
	5				ICH_ELSR	0x0000000F	Interrupt Controller Empty List Register Status Register		
c12	0				ICH_LR0	0x00000000	Interrupt Controller List Register 0		
	1				ICH_LR1	0x00000000	Interrupt Controller List Register 1		
	2				ICH_LR1	0x00000000	Interrupt Controller List Register 2		
	3				ICH_LR1	0x00000000	Interrupt Controller List Register 3		
c14	0				0	ICH_LRC0	0x00000000	Interrupt Controller List Register 0	
					1	ICH_LRC1	0x00000000	Interrupt Controller List Register 1	
					2	ICH_LRC2	0x00000000	Interrupt Controller List Register 2	
					3	ICH_LRC3	0x00000000	Interrupt Controller List Register 3	
6	c12				4	ICC_MCTLR	0x00000400	Interrupt Control Register for EL3	
					5	ICC_MSRE	0x00000000	System Register Enable Register for EL3	
		7	ICC_MGRPEN1	0x00000000	Interrupt Controller Monitor Interrupt Group 1 Enable register				

- a. This is the reset value in non-secure state. In secure state, the reset value is 0x00000002.

4.4.13 c13 registers

Table 4-133 shows the 32-bit wide system registers you can access when the processor is in AArch32 state and the value of CRn is c13.

Table 4-133 c13 register summary

CRn	Op1	CRm	Op2	Name	Reset	Description
c13	0	c0	0	FCSEIDR	0x00000000	FCSE Process ID Register on page 4-267
			1	CONTEXTIDR	UNK	Context ID Register ^a
			2	TPIDRURW	UNK	User Read/Write Thread ID Register ^a
			3	TPIDRURO	UNK	User Read-Only Thread ID Register ^a
			4	TPIDRPRW	UNK	EL1 only Thread ID Register ^a
4	c0	2	HTPIDR	UNK	Hyp Software Thread ID Register ^a	

- a. See the *ARM® Architecture Reference Manual ARMv8, for ARMv8-A architecture profile*.

4.4.14 c14 registers

Table 4-134 shows the CP15 system registers when the processor is in AArch32 state and the value of CRn is c14. See the *ARM® Architecture Reference Manual ARMv8, for ARMv8-A architecture profile* for more information.

Table 4-134 c14 register summary

Op1	CRm	Op2	Name	Reset	Description
0	c0	0	CNTFRQ	UNK	Timer Counter Frequency Register
	c1	0	CNTKCTL	..a	Timer Control Register
c2	0	0	CNTP_TVAL	UNK	Physical Timer TimerValue Register
		1	CNTP_CTL	..b	Physical Timer Control Register
c3	0	0	CNTV_TVAL	UNK	Virtual Timer TimerValue Register
		1	CNTV_CTL	..b	Counter-timer Virtual Timer Control Register
c8	0	0	PMEVCNTR0	UNK	Performance Monitor Event Count Registers
		1	PMEVCNTR1	UNK	
		2	PMEVCNTR2	UNK	
		3	PMEVCNTR3	UNK	
		4	PMEVCNTR4	UNK	
		5	PMEVCNTR5	UNK	

Table 4-134 c14 register summary (continued)

Op1	CRm	Op2	Name	Reset	Description
	c12	0	PMEVTYPER0	UNK	Performance Monitor Event Type Registers
		1	PMEVTYPER1	UNK	
		2	PMEVTYPER2	UNK	
		3	PMEVTYPER3	UNK	
		4	PMEVTYPER4	UNK	
		5	PMEVTYPER5	UNK	
	c15	7	PMCCFILTR	0x00000000	Performance Monitor Cycle Count Filter Register.
4	c1	0	CNTHCTL	-.c	Timer Control Register (EL2)
	c2	0	CNTHP_TVAL	UNK	Physical Timer TimerValue (EL2)
		1	CNTHP_CTL	-.b	Physical Timer Control Register (EL2)

- a. The reset value for bits[9:8, 2:0] is 0b00000.
- b. The reset value for bit[0] is 0.
- c. The reset value for bit[2] is 0 and for bits[1:0] is 0b11.

4.4.15 c15 registers

Table 4-135 shows the 32-bit wide system registers you can access when the processor is in AArch32 state and the value of CRn is c15.

Table 4-135 c15 register summary

Op1	CRm	Op2	Name	Reset	Description
1	c0	0	L2ACTLR	0x80000000 ^a	<i>L2 Auxiliary Control Register on page 4-267</i>
	c3	0	CBAR	..b	<i>Configuration Base Address Register on page 4-278</i>
3	c0	0	CDBGDR0	UNK	Cache Debug Data Register 0, see <i>Direct access to internal memory on page 6-13</i>
		1	CDBGDR1	UNK	Cache Debug Data Register 1, see <i>Direct access to internal memory on page 6-13</i>
		2	CDBGDR2	UNK	Cache Debug Data Register 2, see <i>Direct access to internal memory on page 6-13</i>
		3	CDBGDR3	UNK	Cache Debug Data Register 3, see <i>Direct access to internal memory on page 6-13</i>
	c2	0	CDBGDCT	UNK	Cache Debug Data Cache Tag Read Operation Register, see <i>Direct access to internal memory on page 6-13</i>
		1	CDBGICT	UNK	Cache Debug Instruction Cache Tag Read Operation Register, see <i>Direct access to internal memory on page 6-13</i>
	c4	0	CDBGDCD	UNK	Cache Debug Cache Debug Data Cache Data Read Operation Register, see <i>Direct access to internal memory on page 6-13</i>
		1	CDBGICD	UNK	Cache Debug Instruction Cache Data Read Operation Register, see <i>Direct access to internal memory on page 6-13</i>
		2	CDBGTD	UNK	Cache Debug TLB Data Read Operation Register, see <i>Direct access to internal memory on page 6-13</i>

- a. This is the reset value for an ACE interface. For a CHI interface the reset value is 0x80004008.
 b. The reset value depends on the processor configuration.

4.4.16 64-bit registers

Table 4-136 shows the 64-bit wide CP15 system registers, accessed by the MCRR and MRRC instructions. See the *ARM® Architecture Reference Manual ARMv8, for ARMv8-A architecture profile* for more information.

Table 4-136 64-bit register summary

Op1	CRm	Name	Reset	Description
0	c2	TTBR0	UNK	Translation Table Base Register 0
1	c2	TTBR1	UNK	Translation Table Base Register 1
4	c2	HTTBR	UNK	Hyp Translation Table Base Register
6	c2	VTTBR	UNK	Virtualization Translation Table Base Register
0	c7	PAR	UNK	Physical Address Register on page 4-251
0	c14	CNTPCT	UNK	Physical Timer Count Register
1	c14	CNTVCT	UNK	Virtual Timer Count Register
2	c14	CNTP_CVAL	UNK	Physical Timer CompareValue Register
3	c14	CNTV_CVAL	UNK	Virtual Timer CompareValue Register
4	c14	CNTVOFF	UNK	Virtual Timer Offset Register
6	c14	CNTHP_CVAL	UNK	Physical Timer CompareValue Register
0	c15	CPUACTLR	0x000000000004C8000	CPU Auxiliary Control Register on page 4-269
1	c15	CPUECTLR	0x0000000000000000	CPU Extended Control Register on page 4-271
2	c15	CPUMERRSR	-	CPU Memory Error Syndrome Register on page 4-273
3	c15	L2MERRSR	-	L2 Memory Error Syndrome Register on page 4-276

4.4.17 AArch32 Identification registers

Table 4-137 shows the identification registers.

Table 4-137 Identification registers

Name	CRn	Op1	CRm	Op2	Reset	Description
MIDR	c0	0	c0	0	0x410FD032	<i>Main ID Register on page 4-157</i>
CTR				1	0x84448004	<i>Cache Type Register on page 4-188</i>
TCMTR				2	0x00000000	<i>TCM Type Register on page 4-160</i>
TLBTR				3	0x00000000	<i>TLB Type Register on page 4-160</i>
MPIDR				5	- ^a	<i>Multiprocessor Affinity Register on page 4-158</i>
REVIDR				6	0x00000000	<i>Revision ID Register on page 4-159</i>
ID_PFR0			c1	0	0x00000131	<i>Processor Feature Register 0 on page 4-160</i>
ID_PFR1				1	0x10011011 ^b	<i>Processor Feature Register 0 on page 4-160</i>
ID_DFR0				2	0x03010066	<i>Debug Feature Register 0 on page 4-163</i>
ID_AFR0				3	0x00000000	<i>Auxiliary Feature Register 0 on page 4-164</i>
ID_MMFR0				4	0x10101105	<i>Memory Model Feature Register 0 on page 4-165</i>
ID_MMFR1				5	0x40000000	<i>Memory Model Feature Register 1 on page 4-166</i>
ID_MMFR2				6	0x01260000	<i>Memory Model Feature Register 2 on page 4-168</i>
ID_MMFR3				7	0x02102211	<i>Memory Model Feature Register 3 on page 4-170</i>
ID_ISAR0			c2	0	0x02101110	<i>Instruction Set Attribute Register 0 on page 4-172</i>
ID_ISAR1				1	0x13112111	<i>Instruction Set Attribute Register 1 on page 4-173</i>
ID_ISAR2				2	0x21232042	<i>Instruction Set Attribute Register 2 on page 4-175</i>
ID_ISAR3				3	0x01112131	<i>Instruction Set Attribute Register 3 on page 4-178</i>
ID_ISAR4				4	0x00011142	<i>Instruction Set Attribute Register 4 on page 4-179</i>
ID_ISAR5	c0	0	c2	5	0x00011121 ^c	<i>Instruction Set Attribute Register 5 on page 4-181</i>
CCSIDR		1	c0	0	-	<i>Cache Size ID Register on page 4-183</i>
CLIDR				1	0x0A200023 ^d	<i>Cache Level ID Register on page 4-185</i>
AIDR				7	0x00000000	<i>Auxiliary ID Register on page 4-187</i>
CSSELR		2	c0	0	0x00000000	<i>Cache Size Selection Register on page 4-187</i>

- The reset value depends on the primary inputs, CLUSTERIDAFF1 and CLUSTERIDAFF2, and the number of cores that the device implements.
- Bits [31:28] are 0x1 if the GIC CPU interface is enabled, and 0x0 otherwise.
- ID_ISAR5 has the value 0x00010001 if the Cryptography Extension is not implemented and enabled.
- The value is 0x09200003 if the L2 cache is not implemented.

4.4.18 AArch32 Virtual memory control registers

Table 4-138 shows the virtual memory control registers.

Table 4-138 Virtual memory control registers

Name	CRn	Op1	CRm	Op2	Reset	Width	Description	
SCTLR	c1	0	c0	0	0x00C50838 ^a	32 bit	System Control Register on page 4-191	
TTBR0	c2	0	c0	0	UNK	32 bit	Translation Table Base Register 0, see the <i>ARM® Architecture Reference Manual ARMv8, for ARMv8-A architecture profile</i>	
		-	c2	-		64 bit		
TTBR1	-	0	c0	1	UNK	32 bit	Translation Table Base Register 1, see the <i>ARM® Architecture Reference Manual ARMv8, for ARMv8-A architecture profile</i>	
		-	c2	-		64 bit		
TTBCR		0	c0	2	0x00000000 ^b	32 bit	Translation Table Base Control Register, see the <i>ARM® Architecture Reference Manual ARMv8, for ARMv8-A architecture profile</i>	
DACR	c3	0	c0	0	UNK	32 bit	Domain Access Control Register on page 4-235	
PRRR	c10	0	c2	0	UNK	32 bit	Primary Region Remap Register on page 4-256	
MAIR0				0		UNK	32 bit	Memory Attribute Indirection Registers 0 and 1 on page 4-259
NMRR				1		UNK	32 bit	Normal Memory Remap Register on page 4-262
MAIR1				1		UNK	32 bit	Memory Attribute Indirection Registers 0 and 1 on page 4-259
AMAIR0				c3		0	0x00000000	32 bit
AMAIR1			1	0x00000000	32 bit	Auxiliary Memory Attribute Indirection Register 1 on page 4-263		
CONTEXTIDR	c13	0	c0	1	UNK	32 bit	Process ID Register, see the <i>ARM® Architecture Reference Manual ARMv8, for ARMv8-A architecture profile</i>	

- The reset value depends on inputs, **CFGTE**, **CFGEND**, and **VINITHI**. The value shown in Table 4-138 assumes these signals are set to LOW.
- The reset value is 0x00000000 for the Secure copy of the register. The reset value for the EAE bit of the Non-secure copy of the register is 0x0. You must program the Non-secure copy of the register with the required initial value, as part of the processor boot sequence.

4.4.19 AArch32 Fault handling registers

Table 4-139 shows the Fault handling registers in the AArch32 Execution state.

Table 4-139 Fault handling registers

Name	CRn	Op1	CRm	Op2	Reset	Description
DFSR	c5	0	c0	0	UNK	<i>Data Fault Status Register on page 4-239</i>
IFSR				1	UNK	<i>Instruction Fault Status Register on page 4-243</i>
ADFSR			c1	0	0x00000000	<i>Auxiliary Data Fault Status Register on page 4-246</i>
AIFSR				1	0x00000000	<i>Auxiliary Instruction Fault Status Register on page 4-246</i>
DFAR	c6	0	c0	0	UNK	Data Fault Address Register, see the <i>ARM® Architecture Reference Manual ARMv8, for ARMv8-A architecture profile</i>
IFAR				2	UNK	Instruction Fault Address Register, see the <i>ARM® Architecture Reference Manual ARMv8, for ARMv8-A architecture profile</i>

The Virtualization registers include additional fault handling registers. For more information see [AArch32 Virtualization registers on page 4-153](#).

4.4.20 AArch32 Other System control registers

Table 4-140 shows the other system registers.

Table 4-140 Other system registers

Name	CRn	Op1	CRm	Op2	Reset	Description
ACTLR	c1	0	c0	1	0x00000000	<i>Auxiliary Control Register on page 4-196</i>
CPACR				2	0x00000000	<i>Architectural Feature Access Control Register on page 4-197</i>
FCSEIDR	c13	0	c0	0	0x00000000	<i>FCSE Process ID Register on page 4-267</i>

4.4.21 AArch32 Address registers

Table 4-141 shows the address translation register and operations. See the *ARM® Architecture Reference Manual ARMv8, for ARMv8-A architecture profile* for more information.

Table 4-141 Address translation operations

Name	CRn	Op1	CRm	Op2	Reset	Width	Description
PAR	c7	0	c4	0	UNK	32-bit	<i>Physical Address Register on page 4-251</i>
	-		c7	-		64-bit	

4.4.22 AArch32 Thread registers

Table 4-142 shows the miscellaneous operations. See the *ARM® Architecture Reference Manual ARMv8, for ARMv8-A architecture profile* for more information.

Table 4-142 Miscellaneous System instructions

Name	CRn	Op1	CRm	Op2	Reset	Description
TPIDRURW	c13	0	c0	2	UNK	User Read/Write Thread ID Register
TPIDRURO				3	UNK	User Read-Only Thread ID Register
TPIDRPRW				4	UNK	EL1 only Thread ID Register
HTPIDR		4	c0	2	UNK	Hyp Software Thread ID Register

4.4.23 AArch32 Performance monitor registers

Table 4-143 shows the performance monitor registers. See the *ARM® Architecture Reference Manual ARMv8, for ARMv8-A architecture profile* for more information.

Table 4-143 Performance monitor registers

Name	CRn	Op1	CRm	Op2	Reset	Description
PMCR	c9	0	c12	0	0x41033000	<i>Performance Monitors Control Register on page 12-7</i>
PMCNTENSET				1	UNK	Performance Monitors Count Enable Set Register
PMCNTENCLR				2	UNK	Performance Monitors Count Enable Clear Register
PMOVS				3	UNK	Performance Monitors Overflow Flag Status Register
PMSWINC				4	UNK	Performance Monitors Software Increment Register
PMSELR				5	UNK	Performance Monitors Event Counter Selection Register
PMCEID0				6	0x63FFFFFF ^a	<i>Performance Monitors Common Event Identification Register 0 on page 12-9</i>
PMCEID1				7	0x00000000	<i>Performance Monitors Common Event Identification Register 1 on page 12-12</i>
PMCCNTR			c13	0	UNK	Performance Monitors Cycle Count Register
PMXEVTYPER				1	UNK	Performance Monitors Selected Event Type Register
PMXVCNTR				2	UNK	Performance Monitors Event Count Registers
PMUSERENR			c14	0	0x00000000	Performance Monitors User Enable Register
PMINTENSET				1	UNK	Performance Monitors Interrupt Enable Set Register
PMINTENCLR				2	UNK	Performance Monitors Interrupt Enable Clear Register
PMOVSSET				3	UNK	Performance Monitor Overflow Flag Status Set Register

Table 4-143 Performance monitor registers (continued)

Name	CRn	Op1	CRm	Op2	Reset	Description
PMEVCNTR0	c14	0	c8	0	UNK	Performance Monitors Event Count Register 0
PMEVCNTR1				1	UNK	
PMEVCNTR2				2	UNK	
PMEVCNTR3				3	UNK	
PMEVCNTR4				4	UNK	
PMEVCNTR5				5	UNK	
PMEVTYPER0			c12	0	UNK	Performance Monitors Selected Event Type Register 0
PMEVTYPER1				1	UNK	
PMEVTYPER2				2	UNK	
PMEVTYPER3				3	UNK	
PMEVTYPER4				4	UNK	
PMEVTYPER5				5	UNK	
PMCCFILTR			c15	7	0x00000000	Performance Monitors Cycle Count Filter Register

a. The reset value is 0x623FFFFFF if L2 cache is not implemented.

4.4.24 AArch32 Secure registers

Table 4-144 shows the Secure registers. See the *ARM® Architecture Reference Manual ARMv8, for ARMv8-A architecture profile* for more information.

Table 4-144 Security registers

Name	CRn	Op1	CRm	Op2	Reset	Description
SCR	c1	0	c1	0	0x00000000	Secure Configuration Register on page 4-199
SDER				1	UNK	Secure Debug Enable Register
NSACR				2	0x00000000 ^a	Non-Secure Access Control Register on page 4-202
VBAR	c12	0	c0	0	0x00000000	Vector Base Address Register on page 4-263
MVBAR				1	UNK	Monitor Vector Base Address Register
ISR			c1	0	UNK	Interrupt Status Register

a. If EL3 is AArch64 then the NSACR reads as 0x00000C00.

4.4.25 AArch32 Virtualization registers

Table 4-145 shows the Virtualization registers. See the *ARM® Architecture Reference Manual ARMv8, for ARMv8-A architecture profile* for more information.

Table 4-145 Virtualization registers

Name	CRn	Op1	CRm	Op2	Reset	Width	Description
VPIDR	c0	4	c0	0	0x410FD032	32-bit	<i>Virtualization Processor ID Register on page 4-189</i>
VMPIDR				5	..a	32-bit	<i>Virtualization Multiprocessor ID Register on page 4-190</i>
HSCTLR	c1	4	c0	0	0x30C50838	32-bit	<i>Hyp System Control Register on page 4-207</i>
HACTLR				1	UNK		<i>Hyp Auxiliary Control Register on page 4-205</i>
HCR			c1	0	0x00000000	32-bit	Hyp Configuration Register
HDCCR				1	0x00000006	32-bit	<i>Hyp Debug Control Register on page 4-217</i>
HCPTR				2	0x000033FF ^b	32-bit	<i>Hyp Architectural Feature Trap Register on page 4-221</i>
HSTR				3	0x00000000	32-bit	Hypervisor System Trap Register
HTCR	c2	4	c0	2	UNK	32-bit	<i>Hyp Translation Control Register on page 4-232</i>
VTCR			c1	2	UNK	32-bit	Virtualization Translation Control Register
HTTBR	-	4	c2	-	UNK	64-bit	Hyp Translation Table Base Register
VTTBR	-	6	c2	-	UNK	64-bit	Virtualization Translation Table Base Register
HADFSR	c5	4	c1	0	0x00000000	32-bit	<i>Hyp Auxiliary Data Fault Status Syndrome Register on page 4-246</i>
HAIFSR				1	0x00000000	32-bit	<i>Hyp Auxiliary Instruction Fault Status Syndrome Register on page 4-246</i>
HSR			c2	0	UNK	32-bit	<i>Hyp Syndrome Register on page 4-246</i>
HDFAR	c6	4	c0	0	UNK	32-bit	Hyp Data Fault Address Register
HIFAR				2	UNK	32-bit	Hyp Instruction Fault Address Register
HPFAR				4	UNK	32-bit	Hyp IPA Fault Address Register
HMAIR0	c10	4	c2	0	UNK	32-bit	Hyp Memory Attribute Indirection Register 0
HMAIR1				1	UNK	32-bit	Hyp Memory Attribute Indirection Register 1
HAMAIRO			c3	0	0x00000000	32-bit	<i>Hyp Auxiliary Memory Attribute Indirection Register 0 on page 4-263</i>
HAMAIR1				1	0x00000000	32-bit	<i>Hyp Auxiliary Memory Attribute Indirection Register 1 on page 4-263</i>
HVBAR	c12	4	c0	0	UNK	32-bit	Hyp Vector Base Address Register

a. The reset value is the value of the Multiprocessor Affinity Register.

b. The reset value depends on the FPU and NEON configuration. If Advanced SIMD and Floating-point are implemented, the reset value is 0x000033FF. If Advanced SIMD and Floating-point are not implemented, the reset value is 0x0000BFFF.

4.4.26 AArch32 GIC system registers

Table 4-146 shows the GIC system registers in AArch32 state.

Table 4-146 AArch32 GIC system registers

Name	CRn	Op1	CRm	Op2	Type	Reset	Width	Description
ICC_SGI1R	-	0	c12	-	WO	-	64-bit	SGI Generation Register 1
ICC_ASGI1R		1	c12	-	WO	-	64-bit	Alternate SGI Generation Register 1
ICC_SGI0R		2	c12	-	WO	-	64-bit	SGI Generation Register 0
ICC_PMR	c4	0	c6	0	RW	0x00000000	32-bit	Priority Mask Register
ICC_IAR0	c12	0	c8	0	RO	-	32-bit	Interrupt Acknowledge Register 0
ICC_EOIR0				1	WO	-	32-bit	End Of Interrupt Register 0
ICC_HPIR0				2	RO	-	32-bit	Highest Priority Pending Interrupt Register 0
ICC_BPR0				3	RW	0x00000002	32-bit	Binary Point Register 0
ICC_AP0R0				4	RW	0x00000000	32-bit	Active Priorities 0 Register 0
ICC_APIR0			c9	0	RW	0x00000000	32-bit	Active Priorities 1 Register 0
ICC_DIR			c11	1	WO	-	32-bit	Deactivate Interrupt Register
ICC_RPR				3	RO	-	32-bit	Running Priority Register
ICC_IAR1			c12	0	RO	-	32-bit	Interrupt Acknowledge Register 1
ICC_EOIR1				1	WO	-	32-bit	End Of Interrupt Register 1
ICC_HPIR1				2	RO	-	32-bit	Highest Priority Pending Interrupt Register 1
ICC_BPR1				3	RW	0x00000003 ^a	32-bit	Binary Point Register 1
ICC_CTLR				4	RW	0x00000400	32-bit	Interrupt Control Register
ICC_SRE				5	RW	0x00000000	32-bit	System Register Enable Register
ICC_IGRPEN0				6	RW	0x00000000	32-bit	Interrupt Group Enable Register 0
ICC_IGRPEN1				7	RW	0x00000000	32-bit	Interrupt Group Enable Register 1
ICH_AP0R0		4	c8	0	RW	0x00000000	32-bit	Interrupt Controller Hyp Active Priorities Register (0,0)
ICH_APIR0			c9	0	RW	0x00000000	32-bit	Interrupt Controller Hyp Active Priorities Register (1,0)
ICC_HSRE				5	RW	0x00000000	32-bit	System Register Enable Register for EL2
ICH_HCR			c11	0	RW	0x00000000	32-bit	Interrupt Controller Hyp Control Register
ICH_VTR				1	RO	0x90000003	32-bit	Interrupt Controller VGIC Type Register
ICH_MISR				2	RO	0x00000000	32-bit	Interrupt Controller Maintenance Interrupt State Register

Table 4-146 AArch32 GIC system registers (continued)

Name	CRn	Op1	CRm	Op2	Type	Reset	Width	Description
ICH_EISR	c12	4	c8	3	RO	0x00000000	32-bit	Interrupt Controller End of Interrupt Status Register
ICH_VMCR				7	RW	0x004C0000	32-bit	Interrupt Controller Virtual Machine Control Register
ICH_ELSR				5	RO	0x0000000F	32-bit	Interrupt Controller Empty List Register Status Register
ICH_LR0			c12	0	RW	0x00000000	32-bit	Interrupt Controller List Register 0
ICH_LR1				1	RW	0x00000000	32-bit	Interrupt Controller List Register 1
ICH_LR1				2	RW	0x00000000	32-bit	Interrupt Controller List Register 2
ICH_LR1				3	RW	0x00000000	32-bit	Interrupt Controller List Register 3
ICH_LRC0			c14	0	RW	0x00000000	32-bit	Interrupt Controller List Register 0
ICH_LRC1				1	RW	0x00000000	32-bit	Interrupt Controller List Register 1
ICH_LRC2				2	RW	0x00000000	32-bit	Interrupt Controller List Register 2
ICH_LRC3				3	RW	0x00000000	32-bit	Interrupt Controller List Register 3
ICC_MCTLR		6	c12	4	RW	0x00000400	32-bit	Interrupt Control Register for EL3
ICC_MSRE				5	RW	0x00000000	32-bit	System Register Enable Register for EL3
ICC_MGRPEN1				7	RW	0x00000000	32-bit	Interrupt Controller Monitor Interrupt Group 1 Enable register

a. This is the reset value in non-secure state. In secure state, the reset value is 0x00000002.

4.4.27 AArch32 Generic Timer registers

See [Chapter 10 Generic Timer](#) for information on the timer registers.

4.4.28 AArch32 Implementation defined registers

Table 4-147 shows the 32-bit wide implementation defined registers. These registers provide test features and any required configuration options specific to the Cortex-A53 processor.

Table 4-147 Memory access registers

Name	CRn	Op1	CRm	Op2	Reset	Description
L2CTLR	c9	1	c0	2	– ^a	<i>L2 Control Register on page 4-251</i>
L2ECTLR				3	0x00000000	<i>L2 Extended Control Register on page 4-253</i>
L2ACTLR	c15	1	c0	0	0x80000000 ^b	<i>L2 Auxiliary Control Register on page 4-267</i>
CBAR			c3	0	– ^a	<i>Configuration Base Address Register on page 4-278</i>
CDBGDR0		3 ^c	c0	0	UNK	Data Register 0, see <i>Direct access to internal memory on page 6-13</i>
CDBGDR1				1	UNK	Data Register 1, see <i>Direct access to internal memory on page 6-13</i>
CDBGDR2				2	UNK	Data Register 2, see <i>Direct access to internal memory on page 6-13</i>
CDBGDCT			c2	0	UNK	Data Cache Tag Read Operation Register, see <i>Direct access to internal memory on page 6-13</i>
CDBGICT				1	UNK	Instruction Cache Tag Read Operation Register, see <i>Direct access to internal memory on page 6-13</i>
CDBGDCD			c4	0	UNK	Data Cache Data Read Operation Register, see <i>Direct access to internal memory on page 6-13</i>
CDBGICD			c4	1	UNK	Instruction Cache Data Read Operation Register, see <i>Direct access to internal memory on page 6-13</i>
CDBGTD				2	UNK	TLB Data Read Operation Register, see <i>Direct access to internal memory on page 6-13</i>
CPUACTLR	-	0	c15	-	0x00000000004C8000	<i>CPU Auxiliary Control Register on page 4-269</i>
CPUECTLR	-	1	c15	-	0x0000000000000000	<i>CPU Extended Control Register on page 4-271</i>
CPUMERRSR	-	2	c15	-	-	<i>CPU Memory Error Syndrome Register on page 4-273</i>
L2MERRSR	-	3	c15	-	-	<i>L2 Memory Error Syndrome Register on page 4-276</i>

a. The reset value depends on the processor configuration.

b. This is the reset value for an ACE interface. For a CHI interface the reset value is 0x80004008.

c. See *Direct access to internal memory on page 6-13* for information on how these registers are used.

4.5 AArch32 register descriptions

This section describes all the CP15 system registers in register number order. [Table 4-122 on page 4-137](#) to [Table 4-136 on page 4-147](#) provide cross-references to individual registers.

4.5.1 Main ID Register

The MIDR characteristics are:

Purpose Provides identification information for the processor, including an implementer code for the device and a device ID number.

Usage constraints This register is accessible as follows:

EL0 (NS)	EL0 (S)	EL1 (NS)	EL1 (S)	EL2	EL3 (SCR.NS = 1)	EL3 (SCR.NS = 0)
-	-	RO	RO	RO	RO	RO

Configurations The MIDR is:

- Architecturally mapped to the AArch64 MIDR_EL1 register. See [Multiprocessor Affinity Register on page 4-15](#).
- Architecturally mapped to external MIDR_EL1 register.

Attributes MIDR is a 32-bit register.

[Figure 4-76](#) shows the MIDR bit assignments.

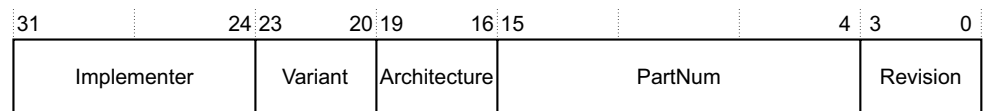

Figure 4-76 MIDR bit assignments

[Table 4-148](#) shows the MIDR bit assignments.

Table 4-148 MIDR bit assignments

Bits	Name	Function
[31:24]	Implementer	Indicates the implementer code. This value is: 0x41 ASCII character 'A' - implementer is ARM Limited.
[23:20]	Variant	Indicates the variant number of the processor. This is the major revision number <i>n</i> in the <i>rn</i> part of the <i>rn</i> pn description of the product revision status. This value is: 0x0 r0p2.
[19:16]	Architecture	Indicates the architecture code. This value is: 0xF Defined by CPUID scheme.
[15:4]	PartNum	Indicates the primary part number. This value is: 0xD03 Cortex-A53 processor.
[3:0]	Revision	Indicates the minor revision number of the processor. This is the minor revision number <i>n</i> in the <i>pn</i> part of the <i>rn</i> pn description of the product revision status. This value is: 0x2 r0p2.

To access the MIDR:

MRC p15, 0, <Rt>, c0, c0, 0; Read MIDR into Rt

Register access is encoded as follows:

Table 4-149 MPIDR access encoding

coproc	opc1	CRn	CRm	opc2
1111	000	0000	0000	000

The MIDR can be accessed through the internal memory-mapped interface and the external debug interface, offset 0xD00.

4.5.2 Multiprocessor Affinity Register

The MPIDR characteristics are:

Purpose Provides an additional core identification mechanism for scheduling purposes in a cluster.
EDDEVAFF0 is a read-only copy of MPIDR accessible from the external debug interface.

Usage constraints This register is accessible as follows:

EL0 (NS)	EL0 (S)	EL1 (NS)	EL1 (S)	EL2	EL3 (SCR.NS = 1)	EL3 (SCR.NS = 0)
-	-	RO	RO	RO	RO	RO

Configurations The MPIDR is:

- Architecturally mapped to the AArch64 MPIDR_EL1[31:0] register. See [Multiprocessor Affinity Register on page 4-15](#).
- Architecturally mapped to external EDDEVAFF0 register.

There is one copy of this register that is used in both Secure and Non-secure states.

Attributes MPIDR is a 32-bit register.

Figure 4-77 shows the MPIDR bit assignments.

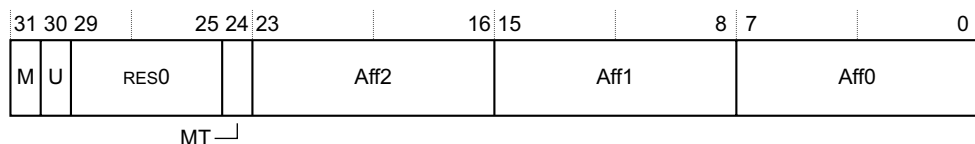

Figure 4-77 MPIDR bit assignments

Table 4-150 shows the MPIDR bit assignments.

Table 4-150 MPIDR bit assignments

Bits	Name	Function
[31]	M	RES1.
[30]	U	Indicates a single core system, as distinct from core 0 in a cluster. This value is: 0 Core is part of a cluster.
[29:25]	-	Reserved, RES0.
[24]	MT	Indicates whether the lowest level of affinity consists of logical cores that are implemented using a multi-threading type approach. This value is: 0 Performance of cores at the lowest affinity level is largely independent.
[23:16]	Aff2	Affinity level 2. Second highest level affinity field. Indicates the value read in the CLUSTERIDAFF2 configuration signal.
[15:8]	Aff1	Affinity level 1. Third highest level affinity field. Indicates the value read in the CLUSTERIDAFF1 configuration signal.
[7:0]	Aff0	Affinity level 0. Lowest level affinity field. Indicates the core number in the Cortex-A53 processor. The possible values are: 0x0 A processor with one core only. 0x0, 0x1 A cluster with two cores. 0x0, 0x1, 0x2 A cluster with three cores. 0x0, 0x1, 0x2, 0x3 A cluster with four cores.

To access the MPIDR:

MRC p15,0,<Rt>,c0,c0,5 ; Read MPIDR into Rt

Register access is encoded as follows:

Table 4-151 MPIDR access encoding

coproc	opc1	CRn	CRm	opc2
1111	000	0000	0000	101

The EDDEVAF0 can be accessed through the internal memory-mapped interface and the external debug interface, offset 0xFA8.

4.5.3 Revision ID Register

The REVIDR characteristics are:

Purpose Provides implementation-specific minor revision information that can be interpreted only in conjunction with the Main ID Register.

Usage constraints This register is accessible as follows:

EL0 (NS)	EL0 (S)	EL1 (NS)	EL1 (S)	EL2	EL3 (SCR.NS = 1)	EL3 (SCR.NS = 0)
-	-	RO	RO	RO	RO	RO

Configurations REVIDR is architecturally mapped to AArch64 register REVIDR_EL1. See *Revision ID Register* on page 4-16.

There is one copy of this register that is used in both Secure and Non-secure states.

Attributes REVIDR is a 32-bit register.

Figure 4-78 shows the REVIDR bit assignments.

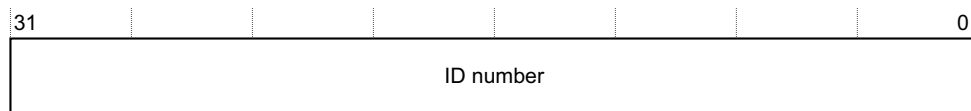

Figure 4-78 REVIDR bit assignments

Table 4-152 shows the REVIDR bit assignments.

Table 4-152 REVIDR bit assignments

Bits	Name	Function
[31:0]	ID number	Implementation-specific revision information. The reset value is determined by the specific Cortex-A53 MPCore implementation. <code>0x00000000</code> Revision code is zero.

To access the REVIDR:

MRC p15, 0, <Rt>, c0, c0, 6; Read REVIDR into Rt

Register access is encoded as follows:

Table 4-153 REVIDR access encoding

coproc	opc1	CRn	CRm	opc2
1111	000	0000	0000	110

4.5.4 TCM Type Register

The processor does not implement the features described by the TCMTR, so this register is always RAZ.

4.5.5 TLB Type Register

The processor does not implement the features described by the TLBTR, so this register is always RAZ.

4.5.6 Processor Feature Register 0

The ID_PFR0 characteristics are:

Purpose Gives top-level information about the instruction sets supported by the processor in AArch32.

Usage constraints This register is accessible as follows:

EL0 (NS)	EL0 (S)	EL1 (NS)	EL1 (S)	EL2	EL3 (SCR.NS = 1)	EL3 (SCR.NS = 0)
-	-	RO	RO	RO	RO	RO

ID_PFR0 must be interpreted with ID_PFR1.

Configurations ID_PFR0 is architecturally mapped to AArch64 register ID_PFR0_EL1. See *AArch32 Processor Feature Register 0* on page 4-17.

There is one copy of this register that is used in both Secure and Non-secure states.

Attributes ID_PFR0 is a 32-bit register.

Figure 4-79 shows the ID_PFR0 bit assignments.

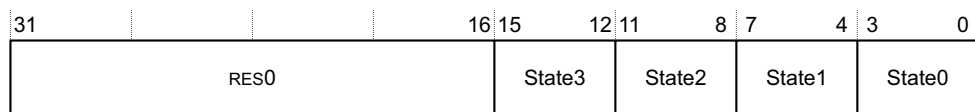

Figure 4-79 ID_PFR0 bit assignments

Table 4-154 shows the ID_PFR0 bit assignments.

Table 4-154 ID_PFR0 bit assignments

Bits	Name	Function
[31:16]	-	Reserved, RES0.
[15:12]	State3	Indicates support for <i>Thumb Execution Environment (T32EE)</i> instruction set. This value is: 0x0 Processor does not support the T32EE instruction set.
[11:8]	State2	Indicates support for Jazelle. This value is: 0x1 Processor supports trivial implementation of Jazelle.
[7:4]	State1	Indicates support for T32 instruction set. This value is: 0x3 Processor supports T32 encoding after the introduction of Thumb-2 technology, and for all 16-bit and 32-bit T32 basic instructions.
[3:0]	State0	Indicates support for A32 instruction set. This value is: 0x1 A32 instruction set implemented.

To access the ID_PFR0:

MRC p15,0,<Rt>,c0,c1,0 ; Read ID_PFR0 into Rt

Register access is encoded as follows:

Table 4-155 ID_PFR0 access encoding

coproc	opc1	CRn	CRm	opc2
1111	000	0000	0001	000

4.5.7 Processor Feature Register 1

The ID_PFR1 characteristics are:

Purpose Provides information about the programmers model and architecture extensions supported by the processor.

Usage constraints This register is accessible as follows:

EL0 (NS)	EL0 (S)	EL1 (NS)	EL1 (S)	EL2	EL3 (SCR.NS = 1)	EL3 (SCR.NS = 0)
-	-	RO	RO	RO	RO	RO

Must be interpreted with ID_PFR0.

Configurations ID_PFR1 is architecturally mapped to AArch64 register ID_PFR1_EL1. See *AArch32 Processor Feature Register 1* on page 4-18.

There is one copy of this register that is used in both Secure and Non-secure states.

Attributes ID_PFR1 is a 32-bit register.

Figure 4-80 shows the ID_PFR1 bit assignments.

31	28	27	24	23	20	19	16	15	12	11	8	7	4	3	0
GIC CPU		Reserved				GenTimer		Virtualization		MProgMod		Security		ProgMod	

Figure 4-80 ID_PFR1 bit assignments

Table 4-156 shows the ID_PFR1 bit assignments.

Table 4-156 ID_PFR1 bit assignments

Bits	Name	Function
[31:28]	GIC CPU	GIC CPU support: 0x0 GIC CPU interface is disabled, GICCDISABLE is HIGH. 0x1 GIC CPU interface is enabled, GICCDISABLE is LOW.
[27:20]	-	Reserved, RAZ.
[19:16]	GenTimer	Generic Timer support: 0x1 Generic Timer implemented.
[15:12]	Virtualization	Indicates support for Virtualization: 0x1 Virtualization implemented.
[11:8]	MProgMod	M profile programmers' model support: 0x0 Not supported.
[7:4]	Security	Security support: 0x1 Security implemented. This includes support for Monitor mode and the SMC instruction.
[3:0]	ProgMod,	Indicates support for the standard programmers model for ARMv4 and later. Model must support User, FIQ, IRQ, Supervisor, Abort, Undefined and System modes: 0x1 Supported.

To access the ID_PFR1:

MRC p15,0,<Rt>,c0,c1,1 ; Read ID_PFR1 into Rt

Register access is encoded as follows:

Table 4-157 ID_PFR1 access encoding

coproc	opc1	CRn	CRm	opc2
1111	000	0000	0001	001

4.5.8 Debug Feature Register 0

The ID_DFR0 characteristics are:

Purpose Provides top level information about the debug system in AArch32.

Usage constraints This register is accessible as follows:

EL0 (NS)	EL0 (S)	EL1 (NS)	EL1 (S)	EL2	EL3 (SCR.NS = 1)	EL3 (SCR.NS = 0)
-	-	RO	RO	RO	RO	RO

Must be interpreted with the Main ID Register, MIDR.

Configurations ID_DFR0 is architecturally mapped to AArch64 register ID_DFR0_EL1. See *AArch32 Debug Feature Register 0* on page 4-19.

There is one copy of this register that is used in both Secure and Non-secure states.

Attributes ID_DFR0 is a 32-bit register.

Figure 4-81 shows the ID_DFR0 bit assignments.

31	28	27	24	23	20	19	16	15	12	11	8	7	4	3	0	
RES0				PerfMon		MProfDbg		MMapTrc		CopTrc		Reserved		CopSDBG		CopDbg

Figure 4-81 ID_DFR0 bit assignments

Table 4-158 shows the ID_DFR0 bit assignments.

Table 4-158 ID_DFR0 bit assignments

Bits	Name	Function
[31:28]	-	Reserved, RES0.
[27:24]	PerfMon	Indicates support for performance monitor model: 0x3 Support for <i>Performance Monitor Unit version 3</i> (PMUv3) system registers.
[23:20]	MProfDbg	Indicates support for memory-mapped debug model for M profile processors: 0x0 Processor does not support M profile Debug architecture.
[19:16]	MMapTrc	Indicates support for memory-mapped trace model: 0x1 Support for ARM trace architecture, with memory-mapped access. In the Trace registers, the ETMIDR gives more information about the implementation.
[15:12]	CopTrc	Indicates support for coprocessor-based trace model: 0x0 Processor does not support ARM trace architecture, with CP14 access.
[11:8]	-	Reserved, RAZ.
[7:4]	CopSDBG	Indicates support for coprocessor-based Secure debug model: 0x6 Processor supports v8 Debug architecture, with CP14 access.
[3:0]	CopDbg	Indicates support for coprocessor-based debug model: 0x6 Processor supports v8 Debug architecture, with CP14 access.

To access the ID_DFR0:

MRC p15,0,<Rt>,c0,c1,2 ; Read ID_DFR0 into Rt

Register access is encoded as follows:

Table 4-159 ID_DFR0 access encoding

coproc	opc1	CRn	CRm	opc2
1111	000	0000	0001	010

4.5.9 Auxiliary Feature Register 0

This register is always RES0.

4.5.10 Memory Model Feature Register 0

The ID_MMFR0 characteristics are:

Purpose Provides information about the memory model and memory management support in AArch32.

Usage constraints This register is accessible as follows:

EL0 (NS)	EL0 (S)	EL1 (NS)	EL1 (S)	EL2	EL3 (SCR.NS = 1)	EL3 (SCR.NS = 0)
-	-	RO	RO	RO	RO	RO

Must be interpreted with ID_MMFR1, ID_MMFR2, and ID_MMFR3.
See:

- [Memory Model Feature Register 1](#) on page 4-166.
- [Memory Model Feature Register 2](#) on page 4-168.
- [Memory Model Feature Register 3](#) on page 4-170.

Configurations ID_MMFR0 is architecturally mapped to AArch64 register ID_MMFR0_EL1.

There is one copy of this register that is used in both Secure and Non-secure states.

Attributes ID_MMFR0 is a 32-bit register.

[Figure 4-82](#) shows the ID_MMFR0 bit assignments.

31	28	27	24	23	20	19	16	15	12	11	8	7	4	3	0
InnerShr		FCSE		AuxReg		TCM		ShareLvl		OuterShr		PMSA		VMSA	

Figure 4-82 ID_MMFR0 bit assignments

Table 4-160 shows the ID_MMFR0 bit assignments.

Table 4-160 ID_MMFR0 bit assignments

Bits	Name	Function
[31:28]	InnerShr	Indicates the innermost shareability domain implemented: 0x1 Implemented with hardware coherency support.
[27:24]	FCSE	Indicates support for <i>Fast Context Switch Extension</i> (FCSE): 0x0 Not supported.
[23:20]	AuxReg	Indicates support for Auxiliary registers: 0x1 Support for Auxiliary Control Register only.
[19:16]	TCM	Indicates support for TCMs and associated DMAs: 0x0 Not supported.
[15:12]	ShareLvl	Indicates the number of shareability levels implemented: 0x1 Two levels of shareability implemented.
[11:8]	OuterShr	Indicates the outermost shareability domain implemented: 0x1 Implemented with hardware coherency support.
[7:4]	PMSA	Indicates support for a <i>Protected Memory System Architecture</i> (PMSA): 0x0 Not supported.
[3:0]	VMSA	Indicates support for a <i>Virtual Memory System Architecture</i> (VMSA). 0x5 Support for: <ul style="list-style-type: none"> VMSAv7, with support for remapping and the Access flag. The PXN bit in the Short-descriptor translation table format descriptors. The Long-descriptor translation table format.

To access the ID_MMFR0:

MRC p15,0,<Rt>,c0,c1,4 ; Read ID_MMFR0 into Rt

Register access is encoded as follows:

Table 4-161 ID_MMFR0 access encoding

coproc	opc1	CRn	CRm	opc2
1111	000	0000	0001	100

4.5.11 Memory Model Feature Register 1

The ID_MMFR1 characteristics are:

Purpose Provides information about the memory model and memory management support in AArch32.

Usage constraints This register is accessible as follows:

EL0 (NS)	EL0 (S)	EL1 (NS)	EL1 (S)	EL2	EL3 (SCR.NS = 1)	EL3 (SCR.NS = 0)
-	-	RO	RO	RO	RO	RO

Must be interpreted with ID_MMFR0, ID_MMFR2, and ID_MMFR3.
See:

- [Memory Model Feature Register 0](#) on page 4-165.
- [Memory Model Feature Register 2](#) on page 4-168.
- [Memory Model Feature Register 3](#) on page 4-170.

Configurations ID_MMFR1 is architecturally mapped to AArch64 register ID_MMFR1_EL1.

There is one copy of this register that is used in both Secure and Non-secure states.

Attributes ID_MMFR1 is a 32-bit register.

Figure 4-83 shows the ID_MMFR1 bit assignments.

31	28	27	24	23	20	19	16	15	12	11	8	7	4	3	0
BPred		L1TstCln		L1Uni		L1Hvd		L1UniSW		L1HvdSW		L1UniVA		L1HvdVA	

Figure 4-83 ID_MMFR1 bit assignments

Table 4-162 shows the ID_MMFR1 bit assignments.

Table 4-162 ID_MMFR1 bit assignments

Bits	Name	Function
[31:28]	BPred	Indicates branch predictor management requirements: 0x4 For execution correctness, branch predictor requires no flushing at any time.
[27:24]	L1TstCln	Indicates the supported L1 Data cache test and clean operations, for Harvard or unified cache implementation: 0x0 None supported.
[23:20]	L1Uni	Indicates the supported entire L1 cache maintenance operations, for a unified cache implementation: 0x0 None supported.
[19:16]	L1Hvd	Indicates the supported entire L1 cache maintenance operations, for a Harvard cache implementation: 0x0 None supported.
[15:12]	L1UniSW	Indicates the supported L1 cache line maintenance operations by set/way, for a unified cache implementation: 0x0 None supported.
[11:8]	L1HvdSW	Indicates the supported L1 cache line maintenance operations by set/way, for a Harvard cache implementation: 0x0 None supported.
[7:4]	L1UniVA	Indicates the supported L1 cache line maintenance operations by MVA, for a unified cache implementation: 0x0 None supported.
[3:0]	L1HvdVA	Indicates the supported L1 cache line maintenance operations by MVA, for a Harvard cache implementation: 0x0 None supported.

To access the ID_MMFR1:

MRC p15, 0, <Rt>, c0, c1, 5; Read ID_MMFR1 into Rt

Register access is encoded as follows:

Table 4-163 ID_MMFR1 access encoding

coproc	opc1	CRn	CRm	opc2
1111	000	0000	0001	101

4.5.12 Memory Model Feature Register 2

The ID_MMFR2 characteristics are:

Purpose Provides information about the implemented memory model and memory management support in AArch32.

Usage constraints This register is accessible as follows:

EL0 (NS)	EL0 (S)	EL1 (NS)	EL1 (S)	EL2	EL3 (SCR.NS = 1)	EL3 (SCR.NS = 0)
-	-	RO	RO	RO	RO	RO

Must be interpreted with ID_MMFR0, ID_MMFR1, and ID_MMFR3.
See:

- [Memory Model Feature Register 0](#) on page 4-165.
- [Memory Model Feature Register 1](#) on page 4-166.
- [Memory Model Feature Register 3](#) on page 4-170

Configurations ID_MMFR2 is architecturally mapped to AArch64 register ID_MMFR2_EL1.

There is one copy of this register that is used in both Secure and Non-secure states.

Attributes ID_MMFR2 is a 32-bit register.

Figure 4-84 shows the ID_MMFR2 bit assignments.

31	28	27	24	23	20	19	16	15	12	11	8	7	4	3	0
HWAccFlg		WFIStall		MemBarr		UniTLB		HvdTLB		LL1HvdRng		L1HvdBG		L1HvdFG	

Figure 4-84 ID_MMFR2 bit assignments

Table 4-164 shows the ID_MMFR2 bit assignments.

Table 4-164 ID_MMFR2 bit assignments

Bits	Name	Function
[31:28]	HWAccFlg	Hardware Access Flag. Indicates support for a Hardware Access flag, as part of the VMSAv7 implementation: 0x0 Not supported.
[27:24]	WFIS Stall	Wait For Interrupt Stall. Indicates the support for <i>Wait For Interrupt</i> (WFI) stalling: 0x1 Support for WFI stalling.
[23:20]	MemBarr	Memory Barrier. Indicates the supported CP15 memory barrier operations. 0x2 Supported CP15 memory barrier operations are: <ul style="list-style-type: none"> • <i>Data Synchronization Barrier</i> (DSB). • <i>Instruction Synchronization Barrier</i> (ISB). • <i>Data Memory Barrier</i> (DMB).
[19:16]	UniTLB	Unified TLB. Indicates the supported TLB maintenance operations, for a unified TLB implementation. 0x6 Supported unified TLB maintenance operations are: <ul style="list-style-type: none"> • Invalidate all entries in the TLB. • Invalidate TLB entry by MVA. • Invalidate TLB entries by ASID match. • Invalidate instruction TLB and data TLB entries by MVA All ASID. This is a shared unified TLB operation. • Invalidate Hyp mode unified TLB entry by MVA. • Invalidate entire Non-secure EL1 and EL0 unified TLB. • Invalidate entire Hyp mode unified TLB. • TLBIMVALIS, TLBIMVAALIS, TLBIMVALHIS, TLBIMVAL, TLBIMVAAL, and TLBIMVALH. • TLBIIPAS2IS, TLBIIPAS2LIS, TLBIIPAS2, and TLBIIPAS2L.
[15:12]	HvdTLB	Harvard TLB. Indicates the supported TLB maintenance operations, for a Harvard TLB implementation: 0x0 Not supported.
[11:8]	LL1HvdRng	L1 Harvard cache Range. Indicates the supported L1 cache maintenance range operations, for a Harvard cache implementation: 0x0 Not supported.
[7:4]	L1HvdBG	L1 Harvard cache Background fetch. Indicates the supported L1 cache background prefetch operations, for a Harvard cache implementation: 0x0 Not supported.
[3:0]	L1HvdFG	L1 Harvard cache Foreground fetch. Indicates the supported L1 cache foreground prefetch operations, for a Harvard cache implementation: 0x0 Not supported.

To access the ID_MMFR2:

MRC p15,0,<Rt>,c0,c1,6 ; Read ID_MMFR2 into Rt

Register access is encoded as follows:

Table 4-165 ID_MMFR2 access encoding

coproc	opc1	CRn	CRm	opc2
1111	000	0000	0001	110

4.5.13 Memory Model Feature Register 3

The ID_MMFR3 characteristics are:

Purpose Provides information about the memory model and memory management support in AArch32.

Usage constraints This register is accessible as follows:

EL0 (NS)	EL0 (S)	EL1 (NS)	EL1 (S)	EL2	EL3 (SCR.NS = 1)	EL3 (SCR.NS = 0)
-	-	RO	RO	RO	RO	RO

Must be interpreted with ID_MMFR0, ID_MMFR1, and ID_MMFR2.
See:

- [Instruction Set Attribute Register 0](#) on page 4-172
- [Memory Model Feature Register 1](#) on page 4-166
- [Memory Model Feature Register 2](#) on page 4-168

Configurations ID_MMFR3 is architecturally mapped to AArch64 register ID_MMFR3_EL1. See [AArch32 Memory Model Feature Register 3](#) on page 4-26.

There is one copy of this register that is used in both Secure and Non-secure states.

Attributes ID_MMFR3 is a 32-bit register.

[Figure 4-85](#) shows the ID_MMFR3 bit assignments.

31	28	27	24	23	20	19	16	15	12	11	8	7	4	3	0
Supersec		CMemSz		CohWalk		Reserved		MaintBcst		BPMaint		CMaintSW		CMaintVA	

Figure 4-85 ID_MMFR3 bit assignments

Table 4-166 shows the ID_MMFR3 bit assignments.

Table 4-166 ID_MMFR3 bit assignments

Bits	Name	Function
[31:28]	Supersec	Supersections. Indicates support for supersections: 0x0 Supersections supported.
[27:24]	CMemSz	Cached Memory Size. Indicates the size of physical memory supported by the processor caches: 0x2 1TByte, corresponding to a 40-bit physical address range.
[23:20]	CohWalk	Coherent walk. Indicates whether translation table updates require a clean to the point of unification: 0x1 Updates to the translation tables do not require a clean to the point of unification to ensure visibility by subsequent translation table walks.
[19:16]	-	Reserved, RES0.
[15:12]	MaintBcst	Maintenance broadcast. Indicates whether cache, TLB and branch predictor operations are broadcast: 0x2 Cache, TLB and branch predictor operations affect structures according to shareability and defined behavior of instructions.
[11:8]	BPMaint	Branch predictor maintenance. Indicates the supported branch predictor maintenance operations. 0x2 Supported branch predictor maintenance operations are: <ul style="list-style-type: none"> • Invalidate all branch predictors. • Invalidate branch predictors by MVA.
[7:4]	CMaintSW	Cache maintenance by set/way. Indicates the supported cache maintenance operations by set/way. 0x1 Supported hierarchical cache maintenance operations by set/way are: <ul style="list-style-type: none"> • Invalidate data cache by set/way. • Clean data cache by set/way. • Clean and invalidate data cache by set/way.
[3:0]	CMaintVA	Cache maintenance by MVA. Indicates the supported cache maintenance operations by MVA. 0x1 Supported hierarchical cache maintenance operations by MVA are: <ul style="list-style-type: none"> • Invalidate data cache by MVA.^a • Clean data cache by MVA. • Clean and invalidate data cache by MVA. • Invalidate instruction cache by MVA. • Invalidate all instruction cache entries.

- a. Invalidate data cache by MVA operations are treated as clean and invalidate data cache by MVA operations on the executing core. If the operation is broadcast to another core then it is broadcast as an invalidate data cache by MVA operation.

To access the ID_MMFR3:

MRC p15, 0, <Rt>, c0, c1, 7; Read ID_MMFR3 into Rt

Register access is encoded as follows:

Table 4-167 ID_MMFR3 access encoding

coproc	opc1	CRn	CRm	opc2
1111	000	0000	0001	111

4.5.14 Instruction Set Attribute Register 0

The ID_ISAR0 characteristics are:

Purpose Provides information about the instruction sets implemented by the processor in AArch32.

Usage constraints This register is accessible as follows:

EL0 (NS)	EL0 (S)	EL1 (NS)	EL1 (S)	EL2	EL3 (SCR.NS = 1)	EL3 (SCR.NS = 0)
-	-	RO	RO	RO	RO	RO

Must be interpreted with ID_ISAR1, ID_ISAR2, ID_ISAR3, ID_ISAR4, and ID_ISAR5. See:

- [Instruction Set Attribute Register 1](#) on page 4-173.
- [Instruction Set Attribute Register 2](#) on page 4-175.
- [Instruction Set Attribute Register 3](#) on page 4-178.
- [Instruction Set Attribute Register 4](#) on page 4-179.
- [Instruction Set Attribute Register 5](#) on page 4-181.

Configurations ID_ISAR0 is architecturally mapped to AArch64 register ID_ISAR0_EL1. See [AArch32 Instruction Set Attribute Register 0](#) on page 4-28.

There is one copy of this register that is used in both Secure and Non-secure states.

Attributes ID_ISAR0 is a 32-bit register.

[Figure 4-86](#) shows the ID_ISAR0 bit assignments.

31	28	27	24	23	20	19	16	15	12	11	8	7	4	3	0
RES0		Divide		Debug		Coprocc		CmpBranch		Bitfield		BitCount		Swap	

Figure 4-86 ID_ISAR0 bit assignments

Table 4-168 shows the ID_ISAR0 bit assignments.

Table 4-168 ID_ISAR0 bit assignments

Bits	Name	Function
[31:28]	-	Reserved, RES0.
[27:24]	Divide	Indicates the implemented Divide instructions: 0x2 <ul style="list-style-type: none"> • SDIV and UDIV in the T32 instruction set. • SDIV and UDIV in the A32 instruction set.
[23:20]	Debug	Indicates the implemented Debug instructions: 0x1 BKPT.
[19:16]	Coproc	Indicates the implemented Coprocessor instructions: 0x0 None implemented, except for separately attributed by the architecture including CP15, CP14, Advanced SIMD and Floating-point.
[15:12]	CmpBranch	Indicates the implemented combined Compare and Branch instructions in the T32 instruction set: 0x1 CBNZ and CBZ.
[11:8]	Bitfield	Indicates the implemented bit field instructions: 0x1 BFC, BFI, SBFX, and UBFX.
[7:4]	BitCount	Indicates the implemented Bit Counting instructions: 0x1 CLZ.
[3:0]	Swap	Indicates the implemented Swap instructions in the A32 instruction set: 0x0 None implemented.

To access the ID_ISAR0:

MRC p15, 0, <Rt>, c0, c2, 0 ; Read ID_ISAR0 into Rt

Register access is encoded as follows:

Table 4-169 ID_ISAR0 access encoding

coproc	opc1	CRn	CRm	opc2
1111	000	0000	0010	000

4.5.15 Instruction Set Attribute Register 1

The ID_ISAR1 characteristics are:

Purpose Provides information about the instruction sets implemented by the processor in AArch32.

Usage constraints This register is accessible as follows:

EL0 (NS)	EL0 (S)	EL1 (NS)	EL1 (S)	EL2	EL3 (SCR.NS = 1)	EL3 (SCR.NS = 0)
-	-	RO	RO	RO	RO	RO

Must be interpreted with ID_ISAR0, ID_ISAR2, ID_ISAR3, ID_ISAR4 and ID_ISAR5. See:

- [Instruction Set Attribute Register 0](#) on page 4-172.
- [Instruction Set Attribute Register 2](#) on page 4-175.
- [Instruction Set Attribute Register 3](#) on page 4-178.
- [Instruction Set Attribute Register 4](#) on page 4-179.
- [Instruction Set Attribute Register 5](#) on page 4-181.

Configurations ID_ISAR1 is architecturally mapped to AArch64 register ID_ISAR1_EL1. See [AArch32 Instruction Set Attribute Register 1](#) on page 4-29.

There is one copy of this register that is used in both Secure and Non-secure states.

Attributes ID_ISAR1 is a 32-bit register.

[Figure 4-87](#) shows the ID_ISAR1 bit assignments.

31	28	27	24	23	20	19	16	15	12	11	8	7	4	3	0
Jazelle		Interwork		Immediate		IfThen		Extend		Except_AR		Except		Endian	

Figure 4-87 ID_ISAR1 bit assignments

Table 4-170 shows the ID_ISAR1 bit assignments.

Table 4-170 ID_ISAR1 bit assignments

Bits	Name	Function
[31:28]	Jazelle	Indicates the implemented Jazelle state instructions: 0x1 The BXJ instruction, and the J bit in the PSR.
[27:24]	Interwork	Indicates the implemented Interworking instructions: 0x3 <ul style="list-style-type: none"> The BX instruction, and the T bit in the PSR. The BLX instruction. The PC loads have BX-like behavior. Data-processing instructions in the A32 instruction set with the PC as the destination and the S bit clear, have BX-like behavior.
[23:20]	Immediate	Indicates the implemented data-processing instructions with long immediates: 0x1 <ul style="list-style-type: none"> The MOVT instruction. The MOV instruction encodings with zero-extended 16-bit immediates. The T32 ADD and SUB instruction encodings with zero-extended 12-bit immediates, and other ADD, ADR, and SUB encodings cross-referenced by the pseudocode for those encodings.
[19:16]	IfThen	Indicates the implemented If-Then instructions in the T32 instruction set: 0x1 The IT instructions, and the IT bits in the PSRs.
[15:12]	Extend	Indicates the implemented Extend instructions: 0x2 <ul style="list-style-type: none"> The SXTB, SXTL, UXTB, and UXTL instructions. The SXTB16, SXTAB, SXTAB16, SXTAH, UXTB16, UXTAB, UXTAB16, and UXTAH instructions.
[11:8]	Except_AR	Indicates the implemented A profile exception-handling instructions: 0x1 The SRS and RFE instructions, and the A profile forms of the CPS instruction.
[7:4]	Except	Indicates the implemented exception-handling instructions in the A32 instruction set: 0x1 The LDM (exception return), LDM (user registers), and STM (user registers) instruction versions.
[3:0]	Endian	Indicates the implemented Endian instructions: 0x1 The SETEND instruction, and the E bit in the PSRs.

To access the ID_ISAR1:

MRC p15, 0, <Rt>, c0, c2, 1 ; Read ID_ISAR1 into Rt

Register access is encoded as follows:

Table 4-171 ID_ISAR1 access encoding

coproc	opc1	CRn	CRm	opc2
1111	000	0000	0010	001

4.5.16 Instruction Set Attribute Register 2

The ID_ISAR2 characteristics are:

Purpose Provides information about the instruction sets implemented by the processor in AArch32.

Usage constraints This register is accessible as follows:

EL0 (NS)	EL0 (S)	EL1 (NS)	EL1 (S)	EL2	EL3 (SCR.NS = 1)	EL3 (SCR.NS = 0)
-	-	RO	RO	RO	RO	RO

Must be interpreted with ID_ISAR0, ID_ISAR1, ID_ISAR3, ID_ISAR4 and ID_ISAR5. See.

- [Instruction Set Attribute Register 0](#) on page 4-172.
- [Instruction Set Attribute Register 1](#) on page 4-173.
- [Instruction Set Attribute Register 3](#) on page 4-178.
- [Instruction Set Attribute Register 4](#) on page 4-179.
- [Instruction Set Attribute Register 5](#) on page 4-181.

Configurations ID_ISAR2 is architecturally mapped to AArch64 register ID_ISAR2_EL1. See [AArch32 Instruction Set Attribute Register 2](#) on page 4-30.

There is one copy of this register that is used in both Secure and Non-secure states.

Attributes ID_ISAR2 is a 32-bit register.

[Figure 4-88](#) shows the ID_ISAR2 bit assignments.

31	28	27	24	23	20	19	16	15	12	11	8	7	4	3	0
Reversal		PSR_AR		MultU		MultS		Mult				MemHint		LoadStore	
															MultiAccessInt

Figure 4-88 ID_ISAR2 bit assignments

Table 4-172 shows the ID_ISAR2 bit assignments.

Table 4-172 ID_ISAR2 bit assignments

Bits	Name	Function
[31:28]	Reversal	Indicates the implemented Reversal instructions: 0x2 The REV, REV16, and REVSH instructions. The RBIT instruction.
[27:24]	PSR_AR	Indicates the implemented A and R profile instructions to manipulate the PSR: 0x1 The MRS and MSR instructions, and the exception return forms of data-processing instructions.
<p>———— Note ————</p> <p>The exception return forms of the data-processing instructions are:</p> <ul style="list-style-type: none"> • In the A32 instruction set, data-processing instructions with the PC as the destination and the S bit set. • In the T32 instruction set, the SUBS PC, LR, #N instruction. 		
[23:20]	MultU	Indicates the implemented advanced unsigned Multiply instructions: 0x2 The UMULL and UMLAL instructions. The UMAAL instruction.
[19:16]	MultS	Indicates the implemented advanced signed Multiply instructions. 0x3 <ul style="list-style-type: none"> • The SMULL and SMLAL instructions. • The SMLABB, SMLABT, SMLALBB, SMLALBT, SMLALTB, SMLALTT, SMLATB, SMLATT, SMLAWB, SMLAWT, SMULBB, SMULBT, SMULTB, SMULTT, SMULWB, SMULWT instructions, and the Q bit in the PSRs. • The SMLAD, SMLADX, SMLALD, SMLALDX, SMLSD, SMLSDX, SMLSLD, SMLSLDX, SMMLA, SMMLAR, SMMLS, SMMLSR, SMMUL, SMMULR, SMUAD, SMUADX, SMUSD, and SMUSDX instructions.
[15:12]	Mult	Indicates the implemented additional Multiply instructions: 0x2 The MUL instruction. The MLA instruction. The MLS instruction.
[11:8]	MultiAccessInt	Indicates the support for interruptible multi-access instructions: 0x0 No support. This means the LDM and STM instructions are not interruptible.
[7:4]	MemHint	Indicates the implemented memory hint instructions: 0x4 The PLD instruction. The PLI instruction. The PLDW instruction.
[3:0]	LoadStore	Indicates the implemented additional load/store instructions: 0x2 The LDRD and STRD instructions. The Load Acquire (LDAB, LDAH, LDA, LDAEXB, LDAEXH, LDAEX, and LDAEXD) and Store Release (STLB, STLH, STL, STLEXB, STLEXH, STLEX, and STLEXD) instructions.

To access the ID_ISAR2:

MRC p15, 0, <Rt>, c0, c2, 2 ; Read ID_ISAR2 into Rt

Register access is encoded as follows:

Table 4-173 ID_ISAR2 access encoding

coproc	opc1	CRn	CRm	opc2
1111	000	0000	0010	010

4.5.17 Instruction Set Attribute Register 3

The ID_ISAR3 characteristics are:

Purpose Provides information about the instruction sets implemented by the processor in AArch32.

Usage constraints This register is accessible as follows:

EL0 (NS)	EL0 (S)	EL1 (NS)	EL1 (S)	EL2	EL3 (SCR.NS = 1)	EL3 (SCR.NS = 0)
-	-	RO	RO	RO	RO	RO

Must be interpreted with ID_ISAR0, ID_ISAR1, ID_ISAR2, ID_ISAR4, and ID_ISAR5. See:

- [Instruction Set Attribute Register 0 on page 4-172.](#)
- [Instruction Set Attribute Register 1 on page 4-173.](#)
- [Instruction Set Attribute Register 2 on page 4-175.](#)
- [Instruction Set Attribute Register 4 on page 4-179.](#)
- [Instruction Set Attribute Register 5 on page 4-181.](#)

Configurations ID_ISAR3 is architecturally mapped to AArch64 register ID_ISAR3_EL1. See [AArch32 Instruction Set Attribute Register 3 on page 4-33.](#)

There is one copy of this register that is used in both Secure and Non-secure states.

Attributes ID_ISAR3 is a 32-bit register.

[Figure 4-89](#) shows the ID_ISAR3 bit assignments.

31	28	27	24	23	20	19	16	15	12	11	8	7	4	3	0
ThumbEE		TrueNOP		ThumbCopy		TabBranch		SynchPrim		SVC		SIMD		Saturate	

Figure 4-89 ID_ISAR3 bit assignments

Table 4-174 shows the ID_ISAR3 bit assignments.

Table 4-174 ID_ISAR3 bit assignments

Bits	Name	Function
[31:28]	ThumbEE	Indicates the implemented Thumb Execution Environment (T32EE) instructions: 0x0 None implemented.
[27:24]	TrueNOP	Indicates support for True NOP instructions: 0x1 True NOP instructions in both the A32 and T32 instruction sets, and additional NOP-compatible hints.
[23:20]	ThumbCopy	Indicates the support for T32 non flag-setting MOV instructions: 0x1 Support for T32 instruction set encoding T1 of the MOV (register) instruction, copying from a low register to a low register.
[19:16]	TabBranch	Indicates the implemented Table Branch instructions in the T32 instruction set. 0x1 The TBB and TBH instructions.
[15:12]	SynchPrim	Indicates the implemented Synchronization Primitive instructions. 0x2 <ul style="list-style-type: none"> The LDREX and STREX instructions. The CLREX, LDREXB, STREXB, and STREXH instructions. The LDREXD and STREXD instructions.
[11:8]	SVC	Indicates the implemented SVC instructions: 0x1 The SVC instruction.
[7:4]	SIMD	Indicates the implemented <i>Single Instruction Multiple Data</i> (SIMD) instructions. 0x3 <ul style="list-style-type: none"> The SSAT and USAT instructions, and the Q bit in the PSRs. The PKHBT, PKHTB, QADD16, QADD8, QASX, QSUB16, QSUB8, QSAX, SADD16, SADD8, SASX, SEL, SHADD16, SHADD8, SHASX, SHSUB16, SHSUB8, SHSAX, SSAT16, SSUB16, SSUB8, SSAX, SXTAB16, SXTB16, UADD16, UADD8, UASX, UHADD16, UHADD8, UHASX, UHSUB16, UHSUB8, UHSAX, UQADD16, UQADD8, UQASX, UQSUB16, UQSUB8, UQSAX, USAD8, USADA8, USAT16, USUB16, USUB8, USAX, UXTAB16, UXTB16 instructions, and the GE[3:0] bits in the PSRs.
[3:0]	Saturate	Indicates the implemented Saturate instructions: 0x1 The QADD, QDADD, QDSUB, QSUB and the Q bit in the PSRs.

To access the ID_ISAR3:

MRC p15, 0, <Rt>, c0, c2, 3 ; Read ID_ISAR3 into Rt

Register access is encoded as follows:

Table 4-175 ID_ISAR3 access encoding

coproc	opc1	CRn	CRm	opc2
1111	000	0000	0010	011

4.5.18 Instruction Set Attribute Register 4

The ID_ISAR4 characteristics are:

Purpose Provides information about the instruction sets implemented by the processor in AArch32.

Usage constraints This register is accessible as follows:

EL0 (NS)	EL0 (S)	EL1 (NS)	EL1 (S)	EL2	EL3 (SCR.NS = 1)	EL3 (SCR.NS = 0)
-	-	RO	RO	RO	RO	RO

Must be interpreted with ID_ISAR0, ID_ISAR1, ID_ISAR2, ID_ISAR3, and ID_ISAR5. See:

- [Instruction Set Attribute Register 0](#) on page 4-172.
- [Instruction Set Attribute Register 1](#) on page 4-173.
- [Instruction Set Attribute Register 2](#) on page 4-175.
- [Instruction Set Attribute Register 3](#) on page 4-178.
- [Instruction Set Attribute Register 5](#) on page 4-181.

Configurations ID_ISAR4 is architecturally mapped to AArch64 register ID_ISAR4_EL1. See [AArch32 Instruction Set Attribute Register 4](#) on page 4-34.

There is one copy of this register that is used in both Secure and Non-secure states.

Attributes ID_ISAR4 is a 32-bit register.

[Figure 4-90](#) shows the ID_ISAR4 bit assignments.

31	28	27	24	23	20	19	16	15	12	11	8	7	4	3	0
SWP_frac		PSR_M				Barrier		SMC	Writeback		WithShifts		Unpriv		
															SynchPrim_frac

Figure 4-90 ID_ISAR4 bit assignments

Table 4-176 shows the ID_ISAR4 bit assignments.

Table 4-176 ID_ISAR4 bit assignments

Bits	Name	Function
[31:28]	SWP_frac	Indicates support for the memory system locking the bus for SWP or SWPB instructions: 0x0 SWP and SWPB instructions not implemented.
[27:24]	PSR_M	Indicates the implemented M profile instructions to modify the PSRs: 0x0 None implemented.
[23:20]	SynchPrim_frac	This field is used with the ID_ISAR3.SynchPrim field to indicate the implemented Synchronization Primitive instructions: 0x0 <ul style="list-style-type: none"> • The LDREX and STREX instructions. • The CLREX, LDREXB, LDREXH, STREXB, and STREXH instructions. • The LDREXD and STREXD instructions.
[19:16]	Barrier	Indicates the supported Barrier instructions in the A32 and T32 instruction sets: 0x1 The DMB, DSB, and ISB barrier instructions.
[15:12]	SMC	Indicates the implemented SMC instructions: 0x1 The SMC instruction.
[11:8]	Writeback	Indicates the support for writeback addressing modes: 0x1 Processor supports all of the writeback addressing modes defined in ARMv8.
[7:4]	WithShifts	Indicates the support for instructions with shifts: 0x4 <ul style="list-style-type: none"> • Support for shifts of loads and stores over the range LSL 0-3. • Support for other constant shift options, both on load/store and other instructions. • Support for register-controlled shift options.
[3:0]	Unpriv	Indicates the implemented unprivileged instructions: 0x2 <ul style="list-style-type: none"> • The LDRBT, LDRT, STRBT, and STRT instructions. • The LDRHT, LDRSBT, LDRSHT, and STRHT instructions.

To access the ID_ISAR4:

MRC p15, 0, <Rt>, c0, c2, 4 ; Read ID_ISAR4 into Rt

Register access is encoded as follows:

Table 4-177 ID_ISAR4 access encoding

coproc	opc1	CRn	CRm	opc2
1111	000	0000	0010	100

4.5.19 Instruction Set Attribute Register 5

The ID_ISAR5 characteristics are:

Purpose Provides information about the instruction sets that the processor implements.

Usage constraints This register is accessible as follows:

EL0 (NS)	EL0 (S)	EL1 (NS)	EL1 (S)	EL2	EL3 (SCR.NS = 1)	EL3 (SCR.NS = 0)
-	-	RO	RO	RO	RO	RO

ID_ISAR5 must be interpreted with ID_ISAR0, ID_ISAR1, ID_ISAR2, ID_ISAR3, and ID_ISAR4. See:

- [Instruction Set Attribute Register 0 on page 4-172.](#)
- [Instruction Set Attribute Register 1 on page 4-173.](#)
- [Instruction Set Attribute Register 2 on page 4-175.](#)
- [Instruction Set Attribute Register 3 on page 4-178.](#)
- [Instruction Set Attribute Register 4 on page 4-179.](#)

Configurations ID_ISAR5 is architecturally mapped to AArch64 register ID_ISAR5_EL1. See [AArch32 Instruction Set Attribute Register 5 on page 4-36.](#)

There is one copy of this register that is used in both Secure and Non-secure states.

Attributes ID_ISAR5 is a 32-bit register.

[Figure 4-91](#) shows the ID_ISAR5 bit assignments.

31		20	19	16	15	12	11	8	7	4	3	0
RES0				CRC32		SHA2		SHA1		AES		SEVL

Figure 4-91 ID_ISAR5 bit assignments

Table 4-178 shows the ID_ISAR5 bit assignments.

Table 4-178 ID_ISAR5 bit assignments

Bits	Name	Function
[31:20]	-	Reserved, RES0.
[19:16]	CRC32	Indicates whether CRC32 instructions are implemented in AArch32 state: 0x1 CRC32 instructions are implemented.
[15:12]	SHA2	Indicates whether SHA2 instructions are implemented in AArch32 state: 0x0 Cryptography Extensions are not implemented or are disabled. 0x1 SHA256H, SHA256H2, SHA256SU0, and SHA256SU1 instructions are implemented. See the <i>Cortex™-A53 MPCore Processor Cryptography Extension Technical Reference Manual</i> for more information.
[11:8]	SHA1	Indicates whether SHA1 instructions are implemented in AArch32 state: 0x0 Cryptography Extensions are not implemented or are disabled. 0x1 SHA1C, SHA1P, SHA1M, SHA1H, SHA1SU0, and SHA1SU1 instructions are implemented. See the <i>Cortex™-A53 MPCore Processor Cryptography Extension Technical Reference Manual</i> for more information.
[7:4]	AES	Indicates whether AES instructions are implemented in AArch32 state: 0x0 Cryptography Extensions are not implemented or are disabled. 0x2 AESE, AESD, AESMC and AESIMC, plus PMULL and PMULL2 instructions operating on 64-bit data. See the <i>Cortex™-A53 MPCore Processor Cryptography Extension Technical Reference Manual</i> for more information.
[3:0]	SEVL	Indicates whether the SEVL instruction is implemented: 0x1 SEVL implemented to send event local.

To access the ID_ISAR5:

MRC p15,0,<Rt>,c0,c2,5 ; Read ID_ISAR5 into Rt

Register access is encoded as follows:

Table 4-179 ID_ISAR5 access encoding

coproc	opc1	CRn	CRm	opc2
1111	000	0000	0010	101

4.5.20 Cache Size ID Register

The CCSIDR characteristics are:

Purpose Provides information about the architecture of the caches.

Usage constraints This register is accessible as follows:

EL0 (NS)	EL0 (S)	EL1 (NS)	EL1 (S)	EL2	EL3 (SCR.NS = 1)	EL3 (SCR.NS = 0)
-	-	RO	RO	RO	RO	RO

If CSSELR indicates a cache that is not implemented, then on a read of the CCSIDR the behavior is CONstrained UNPREDICTABLE, and can be one of the following:

- The CCSIDR read is treated as NOP.
- The CCSIDR read is UNDEFINED.
- The CCSIDR read returns an UNKNOWN value (preferred).

Configurations CCSIDR is architecturally mapped to AArch64 register CCSIDR_EL1. See *Cache Size ID Register* on page 4-43.

There is one copy of this register that is used in both Secure and Non-secure states.

The implementation includes one CCSIDR for each cache that it can access. CSSELR selects which Cache Size ID Register is accessible.

Attributes CCSIDR is a 32-bit register.

Figure 4-92 shows the CCSIDR bit assignments.

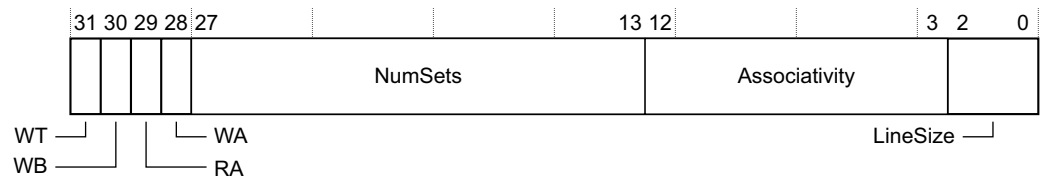

Figure 4-92 CCSIDR bit assignments

Table 4-180 shows the CCSIDR bit assignments.

Table 4-180 CCSIDR bit assignments

Bits	Name	Function
[31]	WT	Indicates support for Write-Through: 0 Cache level does not support Write-Through.
[30]	WB	Indicates support for Write-Back: 0 Cache level does not support Write-Back. 1 Cache level supports Write-Back.
[29]	RA	Indicates support for Read-Allocation: 0 Cache level does not support Read-Allocation. 1 Cache level supports Read-Allocation.
[28]	WA	Indicates support for Write-Allocation: 0 Cache level does not support Write-Allocation. 1 Cache level supports Write-Allocation.
[27:13]	NumSets ^a	Indicates the number of sets in cache - 1. Therefore, a value of 0 indicates 1 set in the cache. The number of sets does not have to be a power of 2.
[12:3]	Associativity ^a	Indicates the associativity of cache - 1. Therefore, a value of 0 indicates an associativity of 1. The associativity does not have to be a power of 2.
[2:0]	LineSize ^a	Indicates the $(\log_2(\text{number of words in cache line})) - 2$: 0b010 16 words per line.

a. For more information about encoding, see Table 4-181 on page 4-185.

Table 4-181 shows the individual bit field and complete register encodings for the CCSIDR. The CSSELR determines which CCSIDR to select.

Table 4-181 CCSIDR encodings

CSSELR	Cache	Size	Complete register encoding	Register bit field encoding						
				WT	WB	RA	WA	NumSets	Associativity	LineSize
0x0	L1 Data cache	8KB	0x7003E01A	0	1	1	1	0x001F	0x003	0x2
		16KB	0x7007E01A					0x003F	0x003	0x2
		32KB	0x700FE01A					0x007F	0x003	0x2
		64KB	0x701FE01A					0x00FF	0x003	0x2
0x1	L1 Instruction cache	8KB	0x2007E00A	0	0	1	0	0x003F	0x001	0x2
		16KB	0x200FE00A					0x007F	0x001	0x2
		32KB	0x201FE00A					0x00FF	0x001	0x2
		64KB	0x203FE00A					0x001F	0x001	0x2
0x2	L2 cache	128KB	0x700FE07A	0	1	1	1	0x007F	0x00F	0x2
		256KB	0x701FE07A					0x00FF	0x00F	0x2
		512KB	0x703FE07A					0x01FF	0x00F	0x2
		1024KB	0x707FE07A					0x03FF	0x00F	0x2
		2048KB	0x70FFE07A					0x07FF	0x00F	0x2
0x3-0xF	Reserved	-	-	-	-	-	-	-	-	

To access the CCSIDR:

MRC p15, 1, <Rt>, c0, c0, 0 ; Read CCSIDR into Rt

Register access is encoded as follows:

Table 4-182 CCSIDR access encoding

coproc	opc1	CRn	CRm	opc2
1111	001	0000	0000	000

4.5.21 Cache Level ID Register

The CLIDR characteristics are:

Purpose

Identifies:

- The type of cache, or caches, implemented at each level.
- The Level of Coherency and Level of Unification for the cache hierarchy.

Usage constraints This register is accessible as follows:

EL0 (NS)	EL0 (S)	EL1 (NS)	EL1 (S)	EL2	EL3 (SCR.NS = 1)	EL3 (SCR.NS = 0)
-	-	RO	RO	RO	RO	RO

Configurations CLIDR is architecturally mapped to AArch64 register CLIDR_EL1. See [Cache Level ID Register on page 4-44](#).

There is one copy of this register that is used in both Secure and Non-secure states.

Attributes CLIDR is a 32-bit register.

[Figure 4-93](#) shows the CLIDR bit assignments.

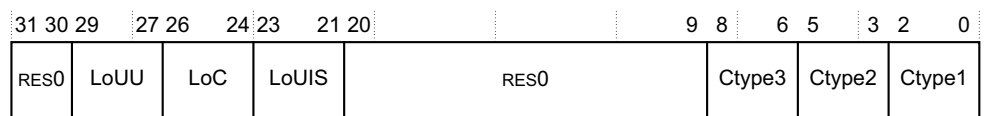

Figure 4-93 CLIDR bit assignments

[Table 4-183](#) shows the CLIDR bit assignments.

Table 4-183 CLIDR bit assignments

Bits	Name	Function
[31:30]	-	Reserved, RES0.
[29:27]	LoUU	Indicates the Level of Unification Uniprocessor for the cache hierarchy: 0b0001 L1 cache is the last level of cache that must be cleaned or invalidated when cleaning or invalidating to the point of unification for the processor.
[26:24]	LoC	Indicates the Level of Coherency for the cache hierarchy: 0b0001 L2 cache not implemented. 0b0010 A clean to the point of coherency operation requires the L1 and L2 caches to be cleaned.
[23:21]	LoUIS	Indicates the Level of Unification Inner Shareable for the cache hierarchy: 0b001 L2 cache. L2 cache is the last level of cache that must be cleaned or invalidated when cleaning or invalidating to the point of unification for the Inner Shareable shareability domain.
[20:6]	-	Reserved, RES0.
[8:6]	Ctype3 ^a	Indicates the type of cache if the processor implements L3 cache: 0b000 L3 cache not implemented.
[5:3]	Ctype2	Indicates the type of cache if the processor implements L2 cache: 0b000 L2 cache is not implemented. 0b100 L2 cache is implemented as a unified cache.
[2:0]	Ctype1	Indicates the type of cache implemented at L1: 0b011 Separate instruction and data caches at L1.

a. If software reads the Cache Type fields from Ctype1 upwards, after it has seen a value of 0b000, no caches exist at further-out levels of the hierarchy. So, for example, if Ctype2 is the first Cache Type field with a value of 0b000, the value of Ctype3 must be ignored.

To access the CLIDR:

Table 4-185 shows the CSSELR bit assignments.

Table 4-185 CSSELR bit assignments

Bits	Name	Function
[31:4]	-	Reserved, RES0.
[3:1]	Level ^a	Cache level of required cache: 0b000 L1. 0b001 L2. 0b010-0b111 Reserved.
[0]	InD ^a	Instruction not Data bit: 0 Data or unified cache. 1 Instruction cache.

a. The combination of Level=0b001 and InD=1 is reserved.

To access the CSSELR:

MRC p15, 2, <Rt>, c0, c0, 0; Read CSSELR into Rt
MCR p15, 2, <Rt>, c0, c0, 0; Write Rt to CSSELR

Register access is encoded as follows:

Table 4-186 CSSELR access encoding

coproc	opc1	CRn	CRm	opc2
1111	010	0000	0001	000

4.5.24 Cache Type Register

The CTR_EL0 characteristics are:

Purpose Provides information about the architecture of the caches.

Usage constraints This register is accessible as follows:

EL0 (NS)	EL0 (S)	EL1 (NS)	EL1 (S)	EL2	EL3 (SCR.NS = 1)	EL3 (SCR.NS = 0)
-	-	RO	RO	RO	RO	RO

Configurations CTR is architecturally mapped to AArch64 register CTR_EL0. See [Cache Type Register on page 4-47](#).

There is one copy of this register that is used in both Secure and Non-secure states.

Attributes CTR is a 32-bit register.

Figure 4-95 on page 4-189 shows the CTR bit assignments.

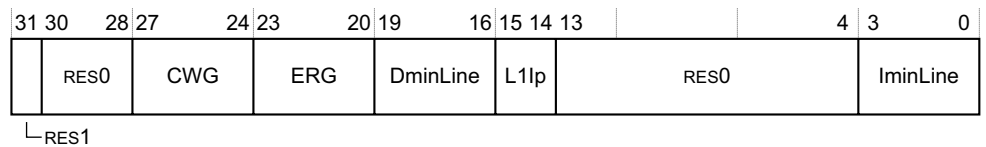

Figure 4-95 CTR bit assignments

Table 4-59 on page 4-47 shows the CTR bit assignments.

Table 4-187 CTR bit assignments

Bits	Name	Function
[31]	-	Reserved, RES1.
[30:28]	-	Reserved, RES0.
[27:24]	CWG	Cache Write-Back granule. \log_2 of the number of words of the maximum size of memory that can be overwritten as a result of the eviction of a cache entry that has had a memory location in it modified: 0×4 Cache Write-Back granule size is 16 words.
[23:20]	ERG	Exclusives Reservation Granule. \log_2 of the number of words of the maximum size of the reservation granule that has been implemented for the Load-Exclusive and Store-Exclusive instructions: 0×4 Exclusive reservation granule size is 16 words.
[19:16]	DminLine	\log_2 of the number of words in the smallest cache line of all the data and unified caches that the processor controls: 0×4 Smallest data cache line size is 16 words.
[15:14]	L1Ip	L1 Instruction cache policy. Indicates the indexing and tagging policy for the L1 Instruction cache: $0 \times b10$ <i>Virtually Indexed Physically Tagged (VIPT)</i> .
[13:4]	-	Reserved, RES0.
[3:0]	IminLine	\log_2 of the number of words in the smallest cache line of all the instruction caches that the processor controls. 0×4 Smallest instruction cache line size is 16 words.

To access the CTR:

MRC p15,0,<Rt>,c0,c0,1 ; Read CTR into Rt

Register access is encoded as follows:

Table 4-188 CTR access encoding

coproc	opc1	CRn	CRm	opc2
1111	010	0000	0000	001

4.5.25 Virtualization Processor ID Register

The VPIDR characteristics are:

Purpose Holds the value of the Virtualization Processor ID. This is the value returned by Non-secure EL1 reads of MIDR. See [MIDR bit assignments on page 4-157](#).

Usage constraints This register is accessible as follows:

EL0 (NS)	EL0 (S)	EL1 (NS)	EL1 (S)	EL2	EL3 (SCR.NS = 1)	EL3 (SCR.NS = 0)
-	-	-	-	RW	RW	-

Configurations VPIDR is architecturally mapped to AArch64 register VPIDR_EL2. See [Virtualization Processor ID Register on page 4-49](#).

Attributes VPIDR is a 32-bit register.
VPIDR resets to the value of MIDR.

Figure 4-96 shows the VPIDR bit assignments.

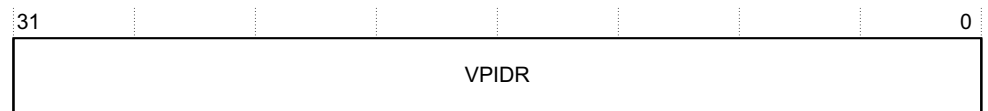

Figure 4-96 VPIDR bit assignments

Table 4-189 shows the VPIDR bit assignments.

Table 4-189 VPIDR bit assignments

Bits	Name	Function
[31:0]	VPIDR	MIDR value returned by Non-secure PL1 reads of the MIDR. The MIDR description defines the subdivision of this value. See MIDR bit assignments on page 4-157 .

To access the VPIDR:

MRC p15,4,<Rt>,c0,c0,0 ; Read VPIDR into Rt
MCR p15,4,<Rt>,c0,c0,0 ; Write Rt to VPIDR

Register access is encoded as follows:

Table 4-190 VPIDR access encoding

coproc	opc1	CRn	CRm	opc2
1111	100	0000	0000	000

4.5.26 Virtualization Multiprocessor ID Register

The VMPIDR characteristics are:

Purpose Provides the value of the Virtualization Multiprocessor ID. This is the value returned by Non-secure EL1 reads of MPIDR.

Usage constraints This register is accessible as follows:

EL0 (NS)	EL0 (S)	EL1 (NS)	EL1 (S)	EL2	EL3 (SCR.NS = 1)	EL3 (SCR.NS = 0)
-	-	-	-	RW	RW	-

Configurations VMPIDR is architecturally mapped to AArch64 register VMPIDR_EL2[31:0]. See [Virtualization Multiprocessor ID Register on page 4-50](#).

This register is accessible only at EL2 or EL3.

Attributes VMPIDR is a 32-bit register.
VMPIDR resets to the value of MPIDR.

Figure 4-97 shows the VMPIDR bit assignments.

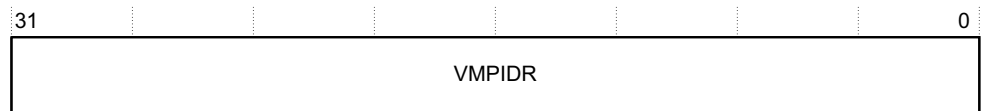

Figure 4-97 VMPIDR bit assignments

Table 4-191 shows the VMPIDR bit assignments.

Table 4-191 VMPIDR bit assignments

Bits	Name	Function
[31:0]	VMPIDR	MPIDR value returned by Non-secure EL1 reads of the MPIDR. The MPIDR description defines the subdivision of this value. See MPIDR bit assignments on page 4-159 .

To access the VMPIDR:

MRC p15,4,<Rt>,c0,c0,5 ; Read VMPIDR into Rt
MCR p15,4,<Rt>,c0,c0,5 ; Write Rt to VMPIDR

Register access is encoded as follows:

Table 4-192 VMPIDR access encoding

coproc	opc1	CRn	CRm	opc2
1111	100	0000	0000	101

4.5.27 System Control Register

The SCTLR characteristics are:

Purpose Provides the top level control of the system, including its memory system.

Usage constraints The SCTLR is accessible as follows:

EL0 (NS)	EL0 (S)	EL1 (NS)	EL1 (S)	EL2	EL3 (SCR.NS = 1)	EL3 (SCR.NS = 0)
-	-	RW	RW	RW	RW	RW

Control bits in the SCTLR that are not applicable to a VMSA implementation read as the value that most closely reflects that implementation, and ignore writes.

Some bits in the register are read-only. These bits relate to non-configurable features of an implementation, and are provided for compatibility with previous versions of the architecture.

Configurations SCTLR (NS) is architecturally mapped to AArch64 register SCTLR_EL1. See *System Control Register, EL1* on page 4-50.

There are separate Secure and Non-secure copies of this register.

SCTLR has write access to the Secure copy of the register disabled when the CP15SDISABLE signal is asserted HIGH.

Attributes SCTLR is a 32-bit register.

Figure 4-98 shows the SCTLR bit assignments.

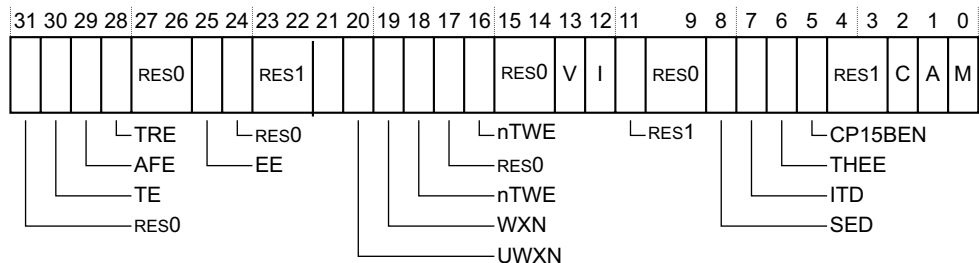

Figure 4-98 SCTLR bit assignments

Table 4-193 shows the SCTLR bit assignments.

Table 4-193 SCTLR bit assignments

Bits	Name	Function
[31]	-	Reserved, RES0.
[30]	TE	T32 Exception enable. This bit controls whether exceptions are taken in A32 or T32 state: 0 Exceptions, including reset, taken in A32 state. 1 Exceptions, including reset, taken in T32 state. The input CFGTE defines the reset value of the TE bit.
[29]	AFE	Access Flag Enable. This bit enables use of the AP[0] bit in the translation descriptors as the Access flag. It also restricts access permissions in the translation descriptors to the simplified model: 0 In the translation table descriptors, AP[0] is an access permissions bit. The full range of access permissions is supported. No Access flag is implemented. This is the reset value. 1 In the translation table descriptors, AP[0] is the Access flag. Only the simplified model for access permissions is supported.
[28]	TRE	TEX remap enable. This bit enables remapping of the TEX[2:1] bits for use as two translation table bits that can be managed by the operating system. Enabling this remapping also changes the scheme used to describe the memory region attributes in the VMSA: 0 TEX remap disabled. TEX[2:0] are used, with the C and B bits, to describe the memory region attributes. This is the reset value. 1 TEX remap enabled. TEX[2:1] are reassigned for use as bits managed by the operating system. The TEX[0], C and B bits are used to describe the memory region attributes, with the MMU remap registers.
[27:26]	-	Reserved, RES0.
[25]	EE	Exception Endianness bit. The value of this bit defines the value of the CPSR.E bit on entry to an exception vector, including reset. This value also indicates the endianness of the translation table data for translation table lookups: 0 Little endian. 1 Big endian. The input CFGEND defines the reset value of the EE bit.
[24]	-	Reserved, RES0.
[23:22]	-	Reserved, RES1.
[21]	-	Reserved, RES0.
[20]	UWXN	Unprivileged write permission implies EL1 <i>Execute Never</i> (XN). This bit can be used to require all memory regions with unprivileged write permissions to be treated as XN for accesses from software executing at EL1. 0 Regions with unprivileged write permission are not forced to be XN, this is the reset value. 1 Regions with unprivileged write permission are forced to be XN for accesses from software executing at EL1.
[19]	WXN	Write permission implies <i>Execute Never</i> (XN). This bit can be used to require all memory regions with write permissions to be treated as XN. 0 Regions with write permission are not forced to be XN, this is the reset value. 1 Regions with write permissions are forced to be XN.
[18]	nTWE	Not trap WFE. 0 If a WFE instruction executed at EL0 would cause execution to be suspended, such as if the event register is not set and there is not a pending WFE wakeup event, it is taken as an exception to EL1 using the 0x1 ESR code. 1 WFE instructions are executed as normal.

Table 4-193 SCTLR bit assignments (continued)

Bits	Name	Function
[17]	-	Reserved, RES0.
[16]	nTWI	Not trap WFI. 0 If a WFI instruction executed at EL0 would cause execution to be suspended, such as if there is not a pending WFI wakeup event, it is taken as an exception to EL1 using the 0x1 ESR code. 1 WFI instructions are executed as normal.
[15:14]	-	Reserved, RES0.
[13]	V	Vectors bit. This bit selects the base address of the exception vectors: 0 Normal exception vectors, base address 0x00000000. Software can remap this base address using the VBAR. 1 High exception vectors, base address 0xFFFF0000. This base address is never remapped. The input VINITHI defines the reset value of the V bit.
[12]	I	Instruction cache enable bit. This is a global enable bit for instruction caches: 0 Instruction caches disabled. If SCTLR.M is set to 0, instruction accesses from stage 1 of the EL0/EL1 translation regime are to Normal memory, Outer Shareable, Inner Non-cacheable, Outer Non-cacheable. 1 Instruction caches enabled. If SCTLR.M is set to 0, instruction accesses from stage 1 of the EL0/EL1 translation regime are to Normal memory, Outer Shareable, Inner Write-Through, Outer Write-Through.

Table 4-193 SCTLR bit assignments (continued)

Bits	Name	Function
[11]	-	Reserved, RES1
[10:9]	-	Reserved, RES0
[8]	SED	SETEND Disable: 0 The SETEND instruction is available. 1 The SETEND instruction is UNALLOCATED.
[7]	ITD	IT Disable: 0 The IT instruction functionality is available. 1 All encodings of the IT instruction with hw1[3:0]!=1000 are UNDEFINED and treated as unallocated. All encodings of the subsequent instruction with the following values for hw1 are UNDEFINED (and treated as unallocated): 11xxxxxxxxxxxx All 32-bit instructions, B(2), B(1), Undefined, SVC, Load/Store multiple 1x11xxxxxxxxxxxx Miscellaneous 16-bit instructions 1x100xxxxxxxxxxxx ADD Rd, PC, #imm 01001xxxxxxxxxxxx LDR Rd, [PC, #imm] 0100x1xxx1111xxx ADD(4),CMP(3), MOV, BX pc, BLX pc 010001xx1xxx111 ADD(4),CMP(3), MOV
[6]	THEE	RES0
[5]	CP15BEN	CP15 barrier enable. 0 CP15 barrier operations disabled. Their encodings are UNDEFINED. 1 CP15 barrier operations enabled.
[4:3]	-	Reserved, RES1.
[2]	C	Cache enable. This is a global enable bit for data and unified caches: 0 Data and unified caches disabled, this is the reset value. 1 Data and unified caches enabled.
[1]	A	Alignment check enable. This is the enable bit for Alignment fault checking: 0 Alignment fault checking disabled, this is the reset value. 1 Alignment fault checking enabled.
[0]	M	MMU enable. This is a global enable bit for the MMU stage 1 address translation: 0 EL1 and EL0 stage 1 MMU disabled. 1 EL1 and EL0 stage 1 MMU enabled.

To access the SCTLR:

MRC p15, 0, <Rt>, c1, c0, 0 ; Read SCTLR into Rt
MCR p15, 0, <Rt>, c1, c0, 0 ; Write Rt to SCTLR

4.5.28 Auxiliary Control Register

The ACTLR characteristics are:

Purpose Controls write access to IMPLEMENTATION DEFINED registers in EL2, such as CPUACTLR, CPUECTLR, L2CTLR, L2ECTLR and L2ACTLR.

Usage constraints This register is accessible as follows:

EL0 NS)	EL0 (S)	EL1 (NS)	EL1 (S)	EL2	EL3 (SCR.NS = 1)	EL3 (SCR.NS = 0)
-	-	RW	RW	RW	RW	RW

Configurations The processor does not implement the ACTLR (NS) register. This register is always RES0. It is mapped to AArch64 register ACTLR_EL1. See [Auxiliary Control Register, EL1 on page 4-55](#).

ACTLR (S) is mapped to AArch64 register ACTLR_EL3. See [Auxiliary Control Register, EL3 on page 4-56](#).

Attributes ACTLR is a 32-bit register.

[Figure 4-99](#) shows the ACTLR bit assignments.

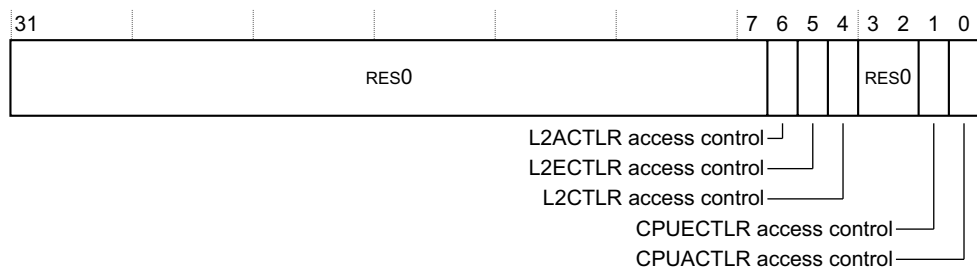

Figure 4-99 ACTLR bit assignments

Table 4-194 shows the ACTLR bit assignments.

Table 4-194 ACTLR bit assignments

Bits	Name	Function
[31:7]	-	Reserved, RES0.
[6]	L2ACTLR access control	L2ACTLR write access control. The possible values are: 0 The register is not write accessible from a lower exception level. This is the reset value. 1 The register is write accessible from EL2.
[5]	L2ECTLR access control	L2ECTLR write access control. The possible values are: 0 The register is not write accessible from a lower exception level. This is the reset value. 1 The register is write accessible from EL2.
[4]	L2CTLR access control	L2CTLR write access control. The possible values are: 0 The register is not write accessible from a lower exception level. This is the reset value. 1 The register is write accessible from EL2.
[3:2]	-	Reserved, RES0.
[1]	CPUECTLR access control	CPUECTLR write access control. The possible values are: 0 The register is not write accessible from a lower exception level. This is the reset value. 1 The register is write accessible from EL2.
[0]	CPUACTLR access control	CPUACTLR write access control. The possible values are: 0 The register is not write accessible from a lower exception level. This is the reset value. 1 The register is write accessible from EL2.

To access the ACTLR:

MRC p15, 0, <Rt>, c1, c0, 1 ; Read ACTLR into Rt
MCR p15, 0, <Rt>, c1, c0, 1 ; Write Rt to ACTLR

4.5.29 Architectural Feature Access Control Register

The CPACR characteristics are:

Purpose Controls access to CP0 to CP13, and indicates which of CP0 to CP13 are implemented.

Usage constraints This register is accessible as follows:

EL0 (NS)	EL0 (S)	EL1 (NS)	EL1 (S)	EL2	EL3 (SCR.NS = 1)	EL3 (SCR.NS = 0)
-	-	RW	RW	RW	RW	RW

The CPACR has no effect on instructions executed at EL2.

Configurations CPACR is architecturally mapped to AArch64 register CPACR_EL1. See [Architectural Feature Access Control Register on page 4-57](#).

There is one copy of this register that is used in both Secure and Non-secure states.

Bits in the NSACR control Non-secure access to the CPACR fields. See the field descriptions cp10 and cp11.

Attributes CPACR is a 32-bit register.

Figure 4-100 shows the CPACR bit assignments.

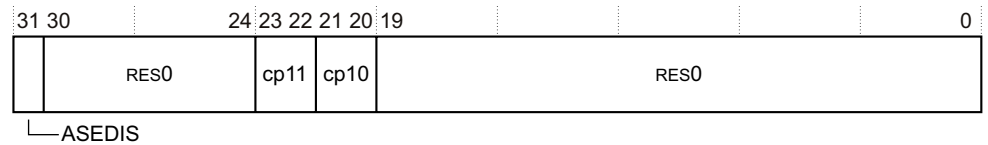

Figure 4-100 CPACR bit assignments

Table 4-195 shows the CPACR bit assignments.

Table 4-195 CPACR bit assignments

Bits	Name	Function
[31]	ASEDIS	Disable Advanced SIMD Functionality: 0 Does not cause any instructions to be UNDEFINED. This is the reset value. 1 All instruction encodings that are part of Advanced SIMD, but that are not floating-point instructions, are UNDEFINED. If Advanced SIMD and Floating-point are not implemented, this bit is RES0.
[30:24]	-	Reserved, RES0.
[23:22]	cp11 ^{ab}	Defines the access rights for CP11, that control the Advanced SIMD and Floating-point features. Possible values of the fields are: 0b00 Access denied. Any attempt to access Advanced SIMD and Floating-point registers or instructions generates an Undefined Instruction exception. This is the reset value. 0b01 Access at EL1 only. Any attempt to access Advanced SIMD and Floating-point registers or instructions from software executing at EL0 generates an Undefined Instruction exception. 0b10 Reserved. 0b11 Full access. If Advanced SIMD and Floating-point are not implemented, this field is RES0.
[21:20]	cp10 ^a	Defines the access rights for CP10, that control the Advanced SIMD and Floating-point features. Possible values of the fields are: 0b00 Access denied. Any attempt to access Advanced SIMD and Floating-point registers or instructions generates an Undefined Instruction exception. This is the reset value. 0b01 Access at EL1 only. Any attempt to access Advanced SIMD and Floating-point registers or instructions from software executing at EL0 generates an Undefined Instruction exception. 0b10 Reserved. 0b11 Full access. If Advanced SIMD and Floating-point are not implemented, this bit is RES0.
[19:0]	-	Reserved, RES0.

- a. The Floating-point and Advanced SIMD features controlled by these fields are:
 Floating-point instructions.
 Advanced SIMD instructions, both integer and floating-point.
 Advanced SIMD and Floating-point registers D0-D31 and their views as S0-S31 and Q0-Q15.
 FPSCR, FPSID, MVFR0, MVFR1, MVFR2, FPEXC system registers.

- b. If the cp11 and cp10 fields are set to different values, the behavior is the same as if both fields were set to the value of cp10, in all respects other than the value read back by explicitly reading cp11.

To access the CPACR:

```
MRC p15,0,<Rt>,c1,c0,2 ; Read CPACR into Rt
MCR p15,0,<Rt>,c1,c0,2 ; Write Rt to CPACR
```

4.5.30 Secure Configuration Register

The SCR characteristics are:

- Purpose** Defines the configuration of the current security state. It specifies:
- The security state of the processor, Secure or Non-secure.
 - What state the processor branches to, if an IRQ, FIQ or external abort occurs.
 - Whether the CPSR.F and CPSR.A bits can be modified when SCR.NS = 1.

Usage constraints This register is accessible as follows:

EL0 NS)	EL0 (S)	EL1 (NS)	EL1 (S)	EL2	EL3 (SCR.NS = 1)	EL3 (SCR.NS = 0)
-	-	-	RW	-	RW	RW

Any read or write to SCR in Secure EL1 state in AArch32 is trapped as an exception to EL3.

Configurations The SCR is a Restricted access register that exists only in the Secure state. The SCR is mapped to the AArch64 SCR_EL3 register.

Attributes SCR is a 32-bit register.

Figure 4-101 shows the SCR bit assignments.

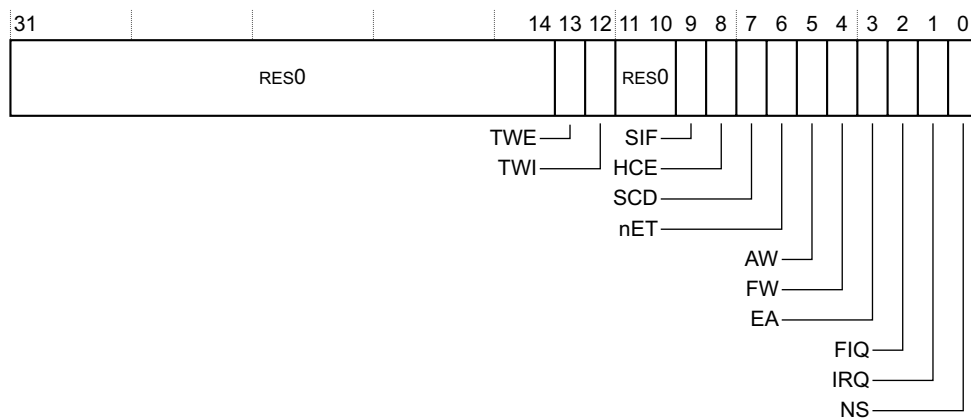

Figure 4-101 SCR bit assignments

Table 4-196 shows the SCR bit assignments.

Table 4-196 SCR bit assignments

Bits	Name	Function
[31:14]	-	Reserved, RES0.
[13]	TWE	Trap WFE instructions. The possible values are: 0 WFE instructions are not trapped. This is the reset value. 1 WFE instructions executed in any mode other than Monitor mode are trapped to Monitor mode as UNDEFINED if the instruction would otherwise cause suspension of execution, that is if: <ul style="list-style-type: none"> • The event register is not set. • There is not a pending WFE wakeup event. • The instruction does not cause another exception.
[12]	TWI	Trap WFI instructions. The possible values are: 0 WFI instructions are not trapped. This is the reset value. 1 WFI instructions executed in any mode other than Monitor mode are trapped to Monitor mode as UNDEFINED if the instruction would otherwise cause suspension of execution.
[11:10]	-	Reserved, RES0.

Table 4-196 SCR bit assignments (continued)

Bits	Name	Function
[9]	SIF	Secure Instruction Fetch. When the processor is in Secure state, this bit disables instruction fetches from Non-secure memory. The possible values are: 0 Secure state instruction fetches from Non-secure memory permitted. This is the reset value. 1 Secure state instruction fetches from Non-secure memory not permitted.
[8]	HCE	Hyp Call enable. This bit enables use of the HVC instruction from Non-secure EL1 modes. The possible values are: 0 The HVC instruction is UNDEFINED in any mode. This is the reset value. 1 The HVC instruction enabled in Non-secure EL1, and performs a Hyp Call.
[7]	SCD	Secure Monitor Call disable. Makes the SMC instruction UNDEFINED in Non-secure state. The possible values are: 0 SMC executes normally in Non-secure state, performing a Secure Monitor Call. This is the reset value. 1 The SMC instruction is UNDEFINED in Non-secure state. A trap of the SMC instruction to Hyp mode takes priority over the value of this bit.
[6]	nET	Not Early Termination. This bit disables early termination. This bit is not implemented, RES0.
[5]	AW	A bit writable. This bit controls whether CPSR.A can be modified in Non-secure state. • CPSR.A can be modified only in Secure state. This is the reset value. • CPSR.A can be modified in any security state.
[4]	FW	F bit writable. This bit controls whether CPSR.F can be modified in Non-secure state: • CPSR.F can be modified only in Secure state. This is the reset value. • CPSR.F can be modified in any security state.
[3]	EA	External Abort handler. This bit controls which mode takes external aborts. The possible values are: 0 External aborts taken in abort mode. This is the reset value. 1 External aborts taken in Monitor mode.
[2]	FIQ	FIQ handler. This bit controls which mode takes FIQ exceptions. The possible values are: 0 FIQs taken in FIQ mode. This is the reset value. 1 FIQs taken in Monitor mode.
[1]	IRQ	IRQ handler. This bit controls which mode takes IRQ exceptions. The possible values are: 0 IRQs taken in IRQ mode. This is the reset value. 1 IRQs taken in Monitor mode.
[0]	NS	Non-secure bit. Except when the processor is in Monitor mode, this bit determines the security state of the processor. The possible values are: 0 Processor is in secure state. This is the reset value. 1 Processor is in non-secure state.

To access the SCR:

MRC p15,0,<Rt>,c1,c1,0 ; Read SCR into Rt
MCR p15,0,<Rt>,c1,c1,0 ; Write Rt to SCR

4.5.31 Secure Debug Enable Register

The SDER characteristics are:

Purpose Controls invasive and non-invasive debug in the Secure EL0 state.

Usage constraints This register is accessible as follows:

EL0 (NS)	EL0 (S)	EL1 (NS)	EL1 (S)	EL2	EL3 (SCR.NS = 1)	EL3 (SCR.NS = 0)
-	-	-	RW	-	RW	RW

Configurations SDER is architecturally mapped to AArch64 register SDER32_EL3. See [Secure Debug Enable Register on page 4-78](#).

This register is accessible only in Secure state.

Attributes SDER is a 32-bit register.

Figure 4-102 shows the SDER bit assignments.

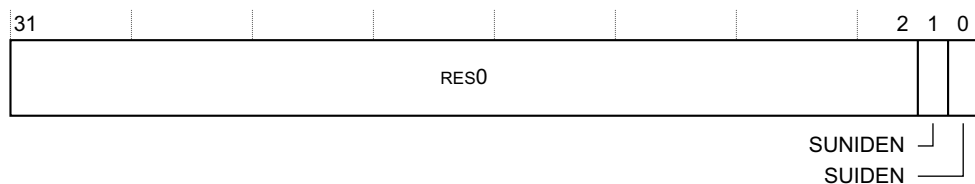

Figure 4-102 SDER bit assignments

Table 4-197 shows the SDER bit assignments.

Table 4-197 SDER bit assignments

Bits	Name	Function
[31:2]	-	Reserved, RES0.
[1]	SUNIDEN	Secure User Non-invasive Debug Enable. The possible values are: 0 Non-invasive debug not permitted in Secure EL0 state. This is the Warm reset value. 1 Non-invasive debug permitted in Secure EL0 state.
[0]	SUIDEN	Secure User Invasive Debug Enable. The possible values are: 0 Invasive debug not permitted in Secure EL0 state. This is the Warm reset value. 1 Invasive debug permitted in Secure EL0 state.

To access the SDER:

```
MRC p15,0,<Rt>,c1,c1,1 ; Read SDER into Rt
MCR p15,0,<Rt>,c1,c1,1 ; Write Rt to SDER
```

4.5.32 Non-Secure Access Control Register

The NSACR characteristics are:

Purpose Defines the Non-secure access permission to CP0 to CP13.

Usage constraints This register is accessible as follows:

EL0 (NS)	EL0 (S)	EL1 (NS)	EL1 (S)	EL2	EL3 (SCR.NS = 1)	EL3 (SCR.NS = 0)
-	-	RO	RO	RO	RW	RW

Any read or write to NSACR in Secure EL1 state in AArch32 is trapped as an exception to EL3.

- Configurations** There is one copy of this register that is used in both Secure and Non-secure states.
- If EL3 is using AArch64, then any reads of the NSACR from Non-secure EL2 or Non-secure EL1 using AArch32 return a fixed value of 0x00000C00.
- In AArch64, the NSACR functionality is replaced by the behavior in CPTR_EL3.

Attributes NSACR is a 32-bit register.

Figure 4-103 shows the NSACR bit assignments.

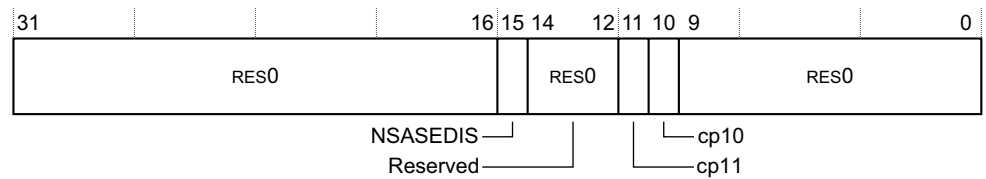

Figure 4-103 NSACR bit assignments

Table 4-198 shows the NSACR bit assignments.

Table 4-198 NSACR bit assignments

Bits	Name	Function
[31:16]	-	Reserved, RES0.
[15]	NSASEDIS	Disable Non-secure Advanced SIMD functionality: 0 This bit has no effect on the ability to write CPACR.ASEDIS, this is the reset value. 1 When executing in Non-secure state, the CPACR.ASEDIS bit has a fixed value of 1 and writes to it are ignored. If Advanced SIMD and Floating-point are not implemented, this bit is RES0.
[14:12]	-	Reserved, RES0.
[11]	cp11	Non-secure access to CP11 enable: 0 Secure access only. Any attempt to access CP11 in Non-secure state results in an Undefined Instruction exception. If the processor is in Non-secure state, the corresponding bits in the CPACR ignore writes and read as 0b00, access denied. This is the reset value. 1 Secure or Non-secure access. If Advanced SIMD and Floating-point are not implemented, this bit is RES0.
[10]	cp10	Non-secure access to CP10 enable: 0 Secure access only. Any attempt to access CP10 in Non-secure state results in an Undefined Instruction exception. If the processor is in Non-secure state, the corresponding bits in the CPACR ignore writes and read as 0b00, access denied. This is the reset value. 1 Secure or Non-secure access. If Advanced SIMD and Floating-point are not implemented, this bit is RES0.
[9:0]	-	Reserved, RES0.

Note

If the values of the cp11 and cp10 fields are not the same, the behavior is UNPREDICTABLE.

To access the NSACR:

```
MRC p15, 0, <Rt>, c1, c1, 2 ; Read NSACR into Rt
MCR p15, 0, <Rt>, c1, c1, 2 ; Write Rt to NSACR
```

4.5.33 Secure Debug Control Register

The SDCR characteristics are:

Purpose Controls debug and performance monitors functionality in Secure state.

Usage constraints This register is accessible as follows:

EL0 (NS)	EL0 (S)	EL1 (NS)	EL1 (S)	EL2	EL3 (SCR.NS = 1)	EL3 (SCR.NS = 0)
-	-	-	RW	-	RW	RW

Configurations SDCR is mapped to AArch64 register MDSCR_EL3.

Attributes SDCR is a 32-bit register.

Figure 4-104 shows the SDCR bit assignments.

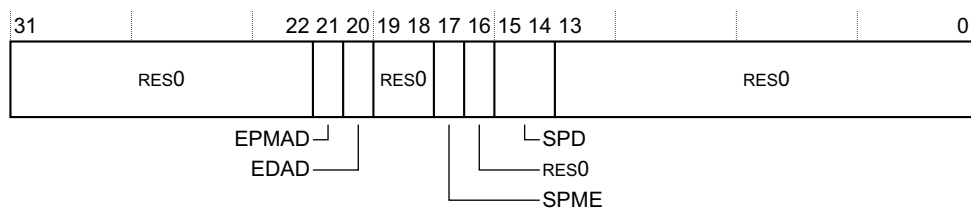

Figure 4-104 SDCR bit assignments

Table 4-199 shows the SDCR bit assignments

Table 4-199 SDCR bit assignments

Bits	Name	Function
[31:22]	-	Reserved, RES0.
[21]	EPMA	External debugger access to Performance Monitors registers disabled. This disables access to these registers by an external debugger: 0 Access to Performance Monitors registers from external debugger is permitted. This is the reset value. 1 Access to Performance Monitors registers from external debugger is disabled, unless overridden by authentication interface.
[20]	EDAD	External debugger access to breakpoint and watchpoint registers disabled. This disables access to these registers by an external debugger: 0 Access to breakpoint and watchpoint registers from external debugger is permitted. This is the reset value. 1 Access to breakpoint and watchpoint registers from external debugger is disabled, unless overridden by authentication interface.
[19:18]	-	Reserved, RES0.
[17]	SPME	Secure performance monitors enable. This allows event counting in Secure state: 0 Event counting prohibited in Secure state, unless overridden by the authentication interface. This is the reset value. 1 Event counting allowed in Secure state.
[16]	-	Reserved, RES0.
[15:14]	SPD	AArch32 secure privileged debug. Enables or disables debug exceptions in Secure state, other than Software breakpoint instructions. The possible values are: 0b00 Legacy mode. Debug exceptions from Secure EL1 are enabled by the authentication interface. 0b10 Secure privileged debug disabled. Debug exceptions from Secure EL1 are disabled. 0b11 Secure privileged debug enabled. Debug exceptions from Secure EL1 are enabled. The value 0b01 is reserved. If debug exceptions from Secure EL1 are enabled, then debug exceptions from Secure EL0 are also enabled. Otherwise, debug exceptions from Secure EL0 are enabled only if SDCR32_EL3.SUIDEN is 1. SPD is ignored in Non-secure state. Debug exceptions from Software breakpoint instruction debug events are always enabled.
[13:0]	-	Reserved, RES0.

To access the SDCR:

```
MRC p15,0,<Rt>,c1,c3,1 ; Read SDCR into Rt
MCR p15,0,<Rt>,c1,c3,1 ; Write Rt to SDCR
```

4.5.34 Hyp Auxiliary Control Register

The HACTLR characteristics are:

Purpose Controls write access to IMPLEMENTATION DEFINED registers in Non-secure EL1 modes, such as CPUACTLR, CPUECTLR, L2CTLR, L2ECTLR and L2ACTLR.

Usage constraints This register is accessible as follows:

EL0 (NS)	EL0 (S)	EL1 (NS)	EL1 (S)	EL2	EL3 (SCR.NS = 1)	EL3 (SCR.NS = 0)
-	-	-	-	RW	RW	-

Configurations The HACTLR is architecturally mapped to the AArch4 ACTLR_EL2 register. See [Auxiliary Control Register, EL2](#) on page 4-55.

Attributes HACTLR is a 32-bit register.

[Figure 4-105](#) shows the HACTLR bit assignments.

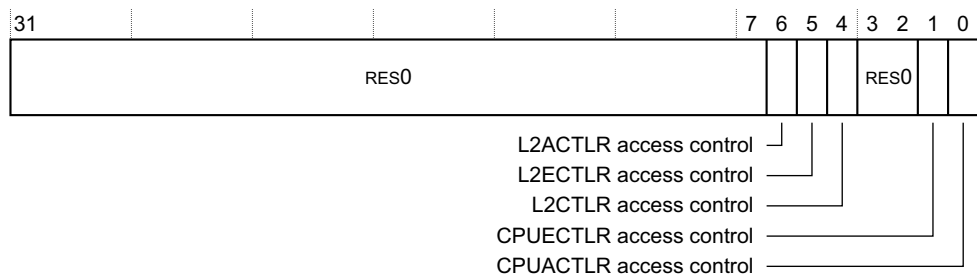

Figure 4-105 HACTLR bit assignments

Table 4-200 shows the HACTLR bit assignments.

Table 4-200 HACTLR bit assignments

Bits	Name	Function
[31:7]	-	Reserved, RES0.
[6]	L2ACTLR access control	L2ACTLR write access control. The possible values are: 0 The register is not write accessible from Non-secure EL1. This is the reset value. 1 The register is write accessible from Non-secure EL1. Write access from Non-secure EL1 also requires ACTLR(S)[6] to be set.
[5]	L2ECTLR access control	L2ECTLR write access control. The possible values are: 0 The register is not write accessible from Non-secure EL1. This is the reset value. 1 The register is write accessible from Non-secure EL1. Write access from Non-secure EL1 also requires ACTLR(S)[5] to be set.
[4]	L2CTLR access control	L2CTLR write access control. The possible values are: 0 The register is not write accessible from Non-secure EL1. This is the reset value. 1 The register is write accessible from Non-secure EL1. Write access from Non-secure EL1 also requires ACTLR(S)[4] to be set.
[3:2]	-	Reserved, RES0.
[1]	CPUECTLR access control	CPUECTLR write access control. The possible values are: 0 The register is not write accessible from Non-secure EL1. This is the reset value. 1 The register is write accessible from Non-secure EL1. Write access from Non-secure EL1 also requires ACTLR(S)[1] to be set.
[0]	CPUACTLR access control	CPUACTLR write access control. The possible values are: 0 The register is not write accessible from Non-secure EL1. This is the reset value. 1 The register is write accessible from Non-secure EL1. Write access from Non-secure EL1 also requires ACTLR(S)[0] to be set.

To access the HACTLR:

MRC p15,4,<Rt>,c1,c0,1 ; Read HACTLR into Rt
 MCR p15,4,<Rt>,c1,c0,1 ; Write Rt to HACTLR

4.5.35 Hyp System Control Register

The HSCTLR characteristics are:

Purpose Provides top level control of the system operation in Hyp mode. This register provides Hyp mode control of features controlled by the Banked SCTL bits, and shows the values of the non-Banked SCTL bits.

Usage constraints This register is accessible as follows:

EL0 (NS)	EL0 (S)	EL1 (NS)	EL1 (S)	EL2	EL3 (SCR.NS = 1)	EL3 (SCR.NS = 0)
-	-	-	-	RW	RW	-

Configurations HSCTLR is architecturally mapped to AArch64 register SCTLR_EL2. See *System Control Register, EL2* on page 4-58.

Attributes HSCTLR is a 32-bit register.

Figure 4-106 shows the HSCTLR bit assignments.

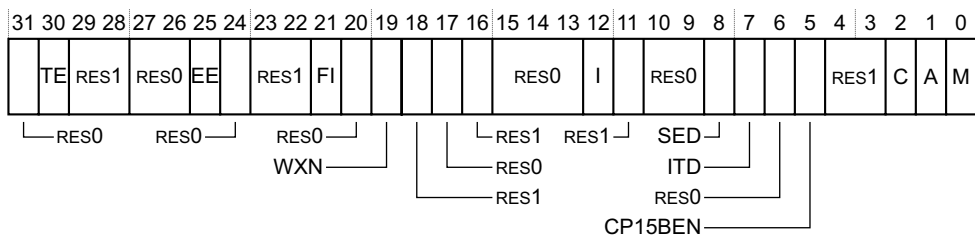

Figure 4-106 HSCTLR bit assignments

Table 4-201 shows the HSCTLR bit assignments.

Table 4-201 HSCTLR bit assignments

Bits	Name	Function
[31]	-	Reserved, RES0.
[30]	TE	Thumb Exception enable. This bit controls whether exceptions taken in Hyp mode are taken in A32 or T32 state: 0 Exceptions taken in A32 state. 1 Exceptions taken in T32 state.
[29:28]	-	Reserved, RES1.
[27:26]	-	Reserved, RES0.
[25]	EE	Exception Endianness. The value of this bit defines the value of the CPSR.E bit on entry to an exception vector, including reset. This value also indicates the endianness of the translation table data for translation table lookups: 0 Little endian. 1 Big endian.
[24]	-	Reserved, RES0.
[23:22]	-	Reserved, RES1.
[21]	FI	Fast Interrupts configuration enable bit. This bit can be used to reduce interrupt latency by disabling implementation-defined performance features. This bit is not implemented, RES0.
[20]	-	Reserved, RES0.
[19]	WXN	Write permission implies <i>Execute Never</i> (XN). This bit can be used to require all memory regions with write permission to be treated as XN: 0 Regions with write permission are not forced to XN. 1 Regions with write permission are forced to XN. The WXN bit is permitted to be cached in a TLB.
[18]	-	Reserved, RES1.
[17]	-	Reserved, RES0.
[16]	-	Reserved, RES1.
[15:13]	-	Reserved, RES0.
[12]	I	Instruction cache enable. This is an enable bit for instruction caches at EL2: 0 Instruction caches disabled at EL2. If HSCTLR.M is set to 0, instruction accesses from stage 1 of the EL2 translation regime are to Normal memory, Outer Shareable, Inner Non-cacheable, Outer Non-cacheable. 1 Instruction caches enabled at EL2. If HSCTLR.M is set to 0, instruction accesses from stage 1 of the EL2 translation regime are to Normal memory, Outer Shareable, Inner Write-Through, Outer Write-Through. When this bit is 0, all EL2 Normal memory instruction accesses are Non-cacheable. If this register is at the highest exception level implemented, field resets to 0. Otherwise, its reset value is UNKNOWN.

Table 4-201 HSCTLR bit assignments (continued)

Bits	Name	Function
[11]	-	Reserved, RES1.
[10:9]	-	Reserved, RES0.
[8]	SED	SETEND Disable: 0 The SETEND instruction is available. 1 The SETEND instruction is UNALLOCATED.
[7]	ITD	IT Disable: 0 The IT instruction functionality is available. 1 All encodings of the IT instruction with hw1[3:0]!=1000 are UNDEFINED and treated as unallocated. All encodings of the subsequent instruction with the following values for hw1 are UNDEFINED (and treated as unallocated): 11xxxxxxxxxxxx All 32-bit instructions, B(2), B(1), Undefined, SVC, Load/Store multiple 1x11xxxxxxxxxxxx Miscellaneous 16-bit instructions 1x100xxxxxxxxxxxx ADD Rd, PC, #imm 01001xxxxxxxxxxxx LDR Rd, [PC, #imm] 0100x1xxx1111xxx ADD(4),CMP(3), MOV, BX pc, BLX pc 010001xx1xxx111 ADD(4),CMP(3), MOV
[6]	-	Reserved, RES0.
[5]	CP15BEN	CP15 barrier enable: 0 CP15 barrier operations disabled. Their encodings are UNDEFINED. 1 CP15 barrier operations enabled.
[4:3]	-	Reserved, RES1.
[2]	C	Cache enable. This is an enable bit for data and unified caches at EL2: 0 Data and unified caches disabled at EL2. 1 Data and unified caches enabled at EL2. When this bit is 0, all EL2 Normal memory data accesses and all accesses to the EL2 translation tables are Non-cacheable. If this register is at the highest exception level implemented, field resets to 0. Otherwise, its reset value is UNKNOWN.
[1]	A	Alignment check enable. This is the enable bit for Alignment fault checking: 0 Alignment fault checking disabled. 1 Alignment fault checking enabled. When this bit is 1, all instructions that load or store one or more registers, other than load/store exclusive and load-acquire/store-release, have an alignment check that the address being accessed is aligned to the size of the data element(s) being accessed. If this check fails it causes an Alignment fault, that is taken as a Data Abort exception. Load/store exclusive and load-acquire/store-release instructions have this alignment check regardless of the value of the A bit. If this register is at the highest exception level implemented, field resets to 0. Otherwise, its reset value is UNKNOWN.

Table 4-201 HSCTLR bit assignments (continued)

Bits	Name	Function
[0]	M	MMU enable. This is a global enable bit for the EL2 stage 1 MMU: 0 EL2 stage 1 MMU disabled. 1 EL2 stage 1 MMU enabled. If this register is at the highest exception level implemented, field resets to 0. Otherwise, its reset value is UNKNOWN.

To access the HSCTLR:

```
MRC p15,4,<Rt>,c1,c0,0 ; Read HSCTLR into Rt
MCR p15,4,<Rt>,c1,c0,0 ; Write Rt to HSCTLR
```

4.5.36 Hyp Configuration Register

The HCR characteristics are:

Purpose Provides configuration controls for virtualization, including defining whether various Non-secure operations are trapped to Hyp mode.

Usage constraints This register is accessible as follows:

EL0 (NS)	EL0 (S)	EL1 (NS)	EL1 (S)	EL2	EL3 (SCR.NS = 1)	EL3 (SCR.NS = 0)
-	-	-	-	RW	RW	-

Configurations HCR is architecturally mapped to AArch64 register HCR_EL2[31:0]. See [Hypervisor Configuration Register on page 4-60](#).

Attributes HCR is a 32-bit register.

Figure 4-107 shows the HCR bit assignments.

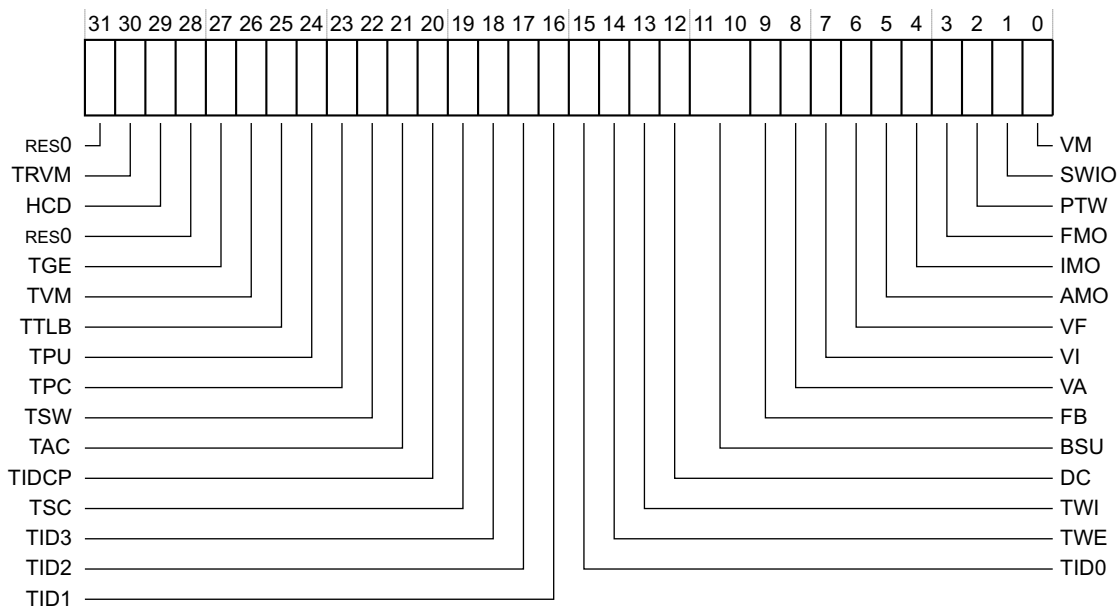

Figure 4-107 HCR bit assignments

[Table 4-202 on page 4-213](#) shows the HCR bit assignments.

Table 4-202 HCR bit assignments

Bits	Name	Function
[31]	-	Reserved, RES0.
[30]	TRVM	<p>Trap Read of Virtual Memory controls.</p> <p>When 1, this causes Reads to the EL1 virtual memory control registers from EL1 to be trapped to EL2. This covers the following registers: SCTLR, TTBR0, TTBR1, TTBCR, DACR, DFSR, IFSR, DFAR, IFAR, ADFSR, AIFSR, PRRR/MAIR0, NMRR/MAIR1, AMAIR0, AMAIR1, and CONTEXTIDR.</p> <p>The reset value is 0.</p>
[29]	HCD	<p>Hyp Call Disable. The HCD value is:</p> <p>0 HVC is enabled at EL1 or EL2.</p> <p>1 HVC is UNDEFINED at all exception levels.</p>
[28]	-	Reserved, RES0.
[27]	TGE	<p>Trap General Exceptions. If this bit is set, and SCR_EL3.NS is set, then: All exceptions that would be routed to EL1 are routed to EL2.</p> <ul style="list-style-type: none"> • The SCTLR.M bit is treated as 0 regardless of its actual state, other than for the purpose of reading the bit. • The HCR.FMO, IMO, and AMO bits are treated as 1 regardless of their actual state, other than for the purpose of reading the bits. • All virtual interrupts are disabled. • Any implementation defined mechanisms for signalling virtual interrupts are disabled. • An exception return to EL1 is treated as an illegal exception return. <p>Additionally, if HCR.TGE is 1, the HDCR.{TDRA,TDOSA,TDA} bits are ignored and the processor behaves as if they are set to 1, other than for the value read back from HDCR.</p> <p>The reset value is 0.</p>
[26]	TVM	<p>Trap Virtual Memory controls. When 1, this causes Writes to the EL1 virtual memory control registers from EL1 to be trapped to EL2. This covers the following registers: SCTLR, TTBR0, TTBR1, TTBCR, DACR, DFSR, IFSR, DFAR, IFAR, ADFSR, AIFSR, PRRR/MAIR0, NMRR/MAIR1, AMAIR0, AMAIR1, and CONTEXTIDR.</p> <p>The reset value is 0.</p>
[25]	TTLB	<p>Trap TLB maintenance instructions. When 1, this causes TLB maintenance instructions executed from EL1 that are not UNDEFINED to be trapped to EL2. This covers the following instructions: TLBIALLIS, TLBIMVAIS, TLBIASIDIS, TLBIMVAAIS, TLBIALL, TLBIMVA, TLBIASID, TLBIMVAA, TLBIMVALIS, TLBIMVAALIS, TLBIMVAL, and TLBIMVAAL.</p> <p>The reset value is 0.</p>
[24]	TPU	<p>Trap Cache maintenance instructions to Point of Unification. When 1, this causes Cache maintenance instructions to the point of unification executed from EL1 or EL0 that are not UNDEFINED to be trapped to EL2. This covers the following instructions: ICIMVAU, ICIALLU, ICIALLUIS, and DCCMVAU.</p> <p>The reset value is 0.</p>
[23]	TPC	<p>Trap Data/Unified Cache maintenance operations to Point of Coherency. When 1, this causes Data or Unified Cache maintenance instructions by address to the point of coherency executed from EL1 or EL0 that are not UNDEFINED to be trapped to EL2. This covers the following instructions: DCIMVAC, DCCIMVAC, and DCCMVAC.</p> <p>The reset value is 0.</p>

Table 4-202 HCR bit assignments (continued)

Bits	Name	Function
[22]	TSW	Trap Data/Unified Cache maintenance operations by Set/Way. When 1, this causes Data or Unified Cache maintenance instructions by set/way executed from EL1 that are not UNDEFINED to be trapped to EL2. This covers the following instructions: DCISW, DCCSW, and DCCISW. The reset value is 0.
[21]	TAC	Trap ACTLR accesses. When this bit is set to 1, any valid Non-secure access to the ACTLR is trapped to Hyp mode. The reset value is 0.
[20]	TIDCP	Trap Implementation Dependent functionality. When 1, this causes accesses to all CP15 MCR and MRC instructions executed from EL1, to be trapped to EL2 as follows: <ul style="list-style-type: none"> • CRn is 9, Opcode1 is 0 to 7, CRm is c0, c1, c2, c5, c6, c7, c8, opcode2 is 0 to 7. • CRn is 10, Opcode1 is 0 to 7, CRm is c0, c1, c4, c8, opcode2 is 0 to 7. • CRn is 11, Opcode1 is 0 to 7, CRm is c0 to c8, or c15, opcode2 is 0 to 7. Accesses from EL0 are UNDEFINED. Resets to 0.
[19]	TSC	Trap SMC instruction. When this bit is set to 1, any attempt from a Non-secure EL1 state to execute an SMC instruction, that passes its condition check if it is conditional, is trapped to Hyp mode. The reset value is 0.
[18]	TID3	Trap ID Group 3. When 1, this causes reads to the following registers executed from EL1 to be trapped to EL2: ID_PFR0, ID_PFR1, ID_DFR0, ID_AFR0, ID_MMFR0, ID_MMFR1, ID_MMFR2, ID_MMFR3, ID_ISAR0, ID_ISAR1, ID_ISAR2, ID_ISAR3, ID_ISAR4, ID_ISAR5, MVFR0, MVFR1, and MVFR2. Also MRC instructions to any of the following encodings: <ul style="list-style-type: none"> • CP15, OPC1 is 0, CRn is 0, CRm is c3, c4, c5, c6, or c7, and Opc2 is 0 or 1. • CP15, Opc1 is 0, CRn is 0, CRm is c3, and Opc2 is 2. • CP15, Opc1 is 0, CRn is 0, CRm is 5, and Opc2 is 4 or 5. The reset value is 0.
[17]	TID2	Trap ID Group 2. When 1, this causes reads (or writes to CSSELR) to the following registers executed from EL1 or EL0 if not UNDEFINED to be trapped to EL2: CTR, CCSIDR, CLIDR, and CSSELR. The reset value is 0.
[16]	TID1	Trap ID Group 1. When 1, this causes reads to the following registers executed from EL1 to be trapped to EL2: TCMTR, TLBTR, AIDR, and REVIDR. The reset value is 0.
[15]	TID0	Trap ID Group 0. When 1, this causes reads to the following registers executed from EL1 or EL0 if not UNDEFINED to be trapped to EL2: FPSID and JIDR. The reset value is 0.
[14]	TWE	Trap WFE. When 1, this causes the WFE instruction executed from EL1 or EL0 to be trapped to EL2 if the instruction would otherwise cause suspension of execution. For example, if the event register is not set: The reset value is 0.
[13]	TWI	Trap WFI. When 1, this causes the WFI instruction executed from EL1 or EL0 to be trapped to EL2 if the instruction would otherwise cause suspension of execution. For example, if there is not a pending WFI wake-up event: The reset value is 0.

Table 4-202 HCR bit assignments (continued)

Bits	Name	Function
[12]	DC	Default cacheable. When this bit is set to 1, and the Non-secure EL1 and EL0 stage 1 MMU is disabled, the memory type and attributes determined by the stage 1 translation is Normal, Non-shareable, Inner Write-Back Write-Allocate, Outer Write-Back Write-Allocate. The reset value is 0.
[11:10]	BSU	Barrier Shareability upgrade. The value in this field determines the minimum shareability domain that is applied to any barrier executed from EL1 or EL0. The possible values are: <ul style="list-style-type: none"> 0b00 No effect. 0b01 Inner Shareable. 0b10 Outer Shareable. 0b11 Full System. The reset value is 0.

Table 4-202 HCR bit assignments (continued)

Bits	Name	Function
[9]	FB	Force broadcast. When 1, this causes the following instructions to be broadcast within the Inner Shareable domain when executed from Non-secure EL1: TLBIALL, TLBIMVA, TLBIASID, TLBIMVAA, BPIALL, and ICIALLU. The reset value is 0.
[8]	VA	Virtual Asynchronous Abort exception. When the AMO bit is set to 1, setting this bit signals a virtual Asynchronous Abort exception to the Guest OS, when the processor is executing in Non-secure state at EL0 or EL1. The Guest OS cannot distinguish the virtual exception from the corresponding physical exception. The reset value is 0.
[7]	VI	Virtual IRQ exception. When the IMO bit is set to 1, setting this bit signals a virtual IRQ exception to the Guest OS, when the processor is executing in Non-secure state at EL0 or EL1. The Guest OS cannot distinguish the virtual exception from the corresponding physical exception. The reset value is 0.
[6]	VF	Virtual FIQ exception. When the FMO bit is set to 1, setting this bit signals a virtual FIQ exception to the Guest OS, when the processor is executing in Non-secure state at EL0 or EL1. The Guest OS cannot distinguish the virtual exception from the corresponding physical exception. The reset value is 0.
[5]	AMO	Asynchronous Abort Mask Override. When this is set to 1, it overrides the effect of CPSR.A, and enables virtual exception signalling by the VA bit. The reset value is 0.
[4]	IMO	IRQ Mask Override. When this is set to 1, it overrides the effect of CPSR.I, and enables virtual exception signalling by the VI bit. The reset value is 0.
[3]	FMO	FIQ Mask Override. When this is set to 1, it overrides the effect of CPSR.F, and enables virtual exception signalling by the VF bit. The reset value is 0.
[2]	PTW	Protected Table Walk. When 1, if the stage 2 translation of a translation table access made as part of a stage 1 translation table walk at EL0 or EL1 maps that translation table access to Device memory, the access is faulted as a stage 2 Permission fault. The reset value is 0.
[1]	SWIO	Set/Way Invalidation Override. When 1, this causes EL1 execution of the data cache invalidate by set/way instruction to be treated as data cache clean and invalidate by set/way. DCISW is executed as DCCISW. This bit is RES1.
[0]	VM	Second stage of Translation enable. When 1, this enables the second stage of translation for execution in EL1 and EL0. The reset value is 0.

To access the HCR:

MRC p15, 4, <Rt>, c1, c1, 0; Read Hyp Configuration Register
MCR p15, 4, <Rt>, c1, c1, 0; Write Hyp Configuration Register

4.5.37 Hyp Configuration Register 2

The HCR2 characteristics are:

Purpose Provides additional configuration controls for virtualization.

Usage constraints This register is accessible as follows:

EL0 (NS)	EL0 (S)	EL1 (NS)	EL1 (S)	EL2	EL3 (SCR.NS = 1)	EL3 (SCR.NS = 0)
-	-	-	-	RW	RW	-

Configurations HCR2 is architecturally mapped to AArch64 register HCR_EL2[63:32]. This register is accessible only at EL2 or EL3.

Attributes HCR2 is a 32-bit register.

Figure 4-108 shows the HCR2 bit assignments.

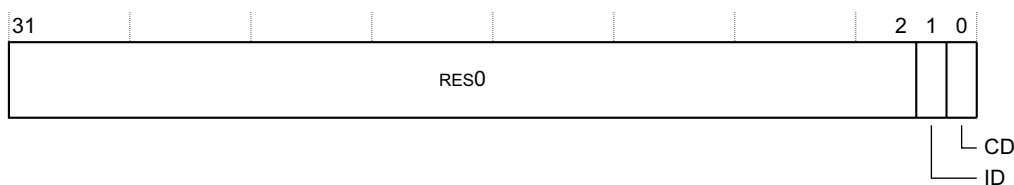

Figure 4-108 HCR2 bit assignments

Table 4-203 shows the HCR2 bit assignments.

Table 4-203 HCR2 bit assignments

Bits	Name	Function
[31:2]	-	Reserved, RES0.
[1]	ID	Stage 2 Instruction cache disable. When HCR.VM is 1, this forces all stage 2 translations for instruction accesses to Normal memory to be Non-cacheable for the EL1/EL0 translation regime. The possible values are: 0 No effect on the stage 2 of the EL1/EL0 translation regime for instruction accesses. 1 Forces all stage 2 translations for instruction accesses to Normal memory to be Non-cacheable for the EL0/EL1 translation regime.
[0]	CD	Stage 2 Data cache disable. When HCR.VM is 1, this forces all stage 2 translations for data accesses and translation table walks to Normal memory to be Non-cacheable for the EL1/EL0 translation regime. The possible values are: 0 No effect on the stage 2 of the EL1/EL0 translation regime for data accesses and translation table walks. 1 Forces all stage 2 translations for data accesses and translation table walks to Normal memory to be Non-cacheable for the EL0/EL1 translation regime.

To access the HCR2:

```
MRC p15,4,<Rt>,c1,c1,4 ; Read HCR2 into Rt
MCR p15,4,<Rt>,c1,c1,4 ; Write Rt to HCR2
```

4.5.38 Hyp Debug Control Register

The HDCR characteristics are:

Purpose Controls the trapping to Hyp mode of Non-secure accesses, at EL1 or lower, to functions provided by the debug and trace architectures and the Performance Monitor.

Usage constraints This register is accessible as follows:

EL0 (NS)	EL0 (S)	EL1 (NS)	EL1 (S)	EL2	EL3 (SCR.NS = 1)	EL3 (SCR.NS = 0)
-	-	-	-	RW	RW	-

- Configurations**
- HDCR is architecturally mapped to AArch64 register MDCR_EL2. See [Hyp Debug Control Register on page 4-66](#).
 - This register is accessible only at EL2 or EL3.

Attributes HDCR is a 32-bit register.

Figure 4-109 shows the HDCR bit assignments.

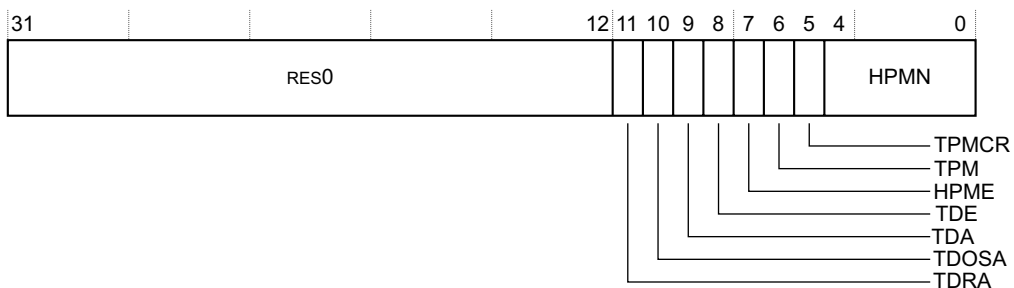

Figure 4-109 HDCR bit assignments

[Table 4-204 on page 4-220](#) shows the HDCR bit assignments.

Table 4-204 HDCR bit assignments

Bits	Name	Function
[31:12]	-	Reserved, RES0.
[11]	TDRA	<p>Trap debug ROM address register access.</p> <p>0 Has no effect on accesses to debug ROM address registers from EL1 and EL0.</p> <p>1 Trap valid Non-secure EL1 and EL0 access to debug ROM address registers to Hyp mode.</p> <p>When this bit is set to 1, any valid Non-secure access to the following registers is trapped to Hyp mode:</p> <ul style="list-style-type: none"> • DBGDRAR. • DBGDSAR. <p>If HCR.TGE is 1 or HDCR.TDE is 1, then this bit is ignored and treated as though it is 1 other than for the value read back from HDCR.</p> <p>On Warm reset, the field resets to 0.</p>
[10]	TDOSA	<p>Trap Debug OS-related register access:</p> <p>0 Has no effect on accesses to CP14 Debug registers.</p> <p>1 Trap valid Non-secure accesses to CP14 OS-related Debug registers to Hyp mode.</p> <p>When this bit is set to 1, any valid Non-secure CP14 access to the following OS-related Debug registers is trapped to Hyp mode:</p> <ul style="list-style-type: none"> • DBGOSLSR. • DBGOSLAR. • DBGOSDLR. • DBGPRCR. <p>If HCR.TGE is 1 or HDCR.TDE is 1, then this bit is ignored and treated as though it is 1 other than for the value read back from HDCR.</p> <p>On Warm reset, the field resets to 0.</p>
[9]	TDA	<p>Trap Debug Access:</p> <p>0 Has no effect on accesses to CP14 Debug registers.</p> <p>1 Trap valid Non-secure accesses to CP14 Debug registers to Hyp mode.</p> <p>When this bit is set to 1, any valid access to the CP14 Debug registers, other than the registers trapped by the TDRA and TDOSA bits, is trapped to Hyp mode.</p> <p>If HCR.TGE is 1 or HDCR.TDE is 1, then this bit is ignored and treated as though it is 1 other than for the value read back from HDCR.</p> <p>On Warm reset, the field resets to 0.</p>
[8]	TDE	<p>Trap Debug Exceptions:</p> <p>0 Has no effect on Debug exceptions.</p> <p>1 Route Non-secure Debug exceptions to Hyp mode.</p> <p>When this bit is set to 1, any Debug exception taken in Non-secure state is trapped to Hyp mode.</p> <p>If HCR.TGE is 1, then this bit is ignored and treated as though it is 1 other than for the value read back from HDCR. This bit resets to 0.</p>
[7]	HPME	<p>Hypervisor Performance Monitor Enable:</p> <p>0 Hyp mode performance monitor counters disabled.</p> <p>1 Hyp mode performance monitor counters enabled.</p> <p>When this bit is set to 1, access to the performance monitors that are reserved for use from Hyp mode is enabled. For more information, see the description of the HPMN field.</p> <p>The reset value of this bit is UNKNOWN.</p>

Table 4-204 HDCR bit assignments (continued)

Bits	Name	Function
[6]	TPM	<p>Trap Performance Monitor accesses:</p> <p>0 Has no effect on performance monitor accesses.</p> <p>1 Trap valid Non-secure performance monitor accesses to Hyp mode.</p> <p>When this bit is set to 1, any valid Non-secure access to the Performance Monitor registers is trapped to Hyp mode. This bit resets to 0. See the <i>ARM® Architecture Reference Manual ARMv8, for ARMv8-A architecture profile</i> for more information.</p>
[5]	TPMCR	<p>Trap Performance Monitor Control Register accesses:</p> <p>0 Has no effect on PMCR accesses.</p> <p>1 Trap valid Non-secure PMCR accesses to Hyp mode.</p> <p>When this bit is set to 1, any valid Non-secure access to the PMCR is trapped to Hyp mode. This bit resets to 0. See the <i>ARM® Architecture Reference Manual ARMv8, for ARMv8-A architecture profile</i> for more information.</p>
[4:0]	HPMN	<p>Hyp Performance Monitor count. Defines the number of Performance Monitors counters that are accessible from Non-secure EL1 and EL0 modes if unprivileged access is enabled.</p> <p>In Non-secure state, HPMN divides the Performance Monitors counters as follows. If software is accessing Performance Monitors counter n then, in Non-secure state:</p> <p>For example, If PMnEVCNTR is performance monitor counter n then, in Non-secure state:</p> <ul style="list-style-type: none"> • If n is in the range $0 \leq n < \text{HPMN}$, the counter is accessible from EL1 and EL2, and from EL0 if unprivileged access to the counters is enabled. • If n is in the range $\text{HPMN} \leq n < \text{PMCR.N}$, the counter is accessible only from EL2. The HPME bit enables access to the counters in this range. <p>If this field is set to 0, or to a value larger than PMCR.N, then the behavior in Non-secure EL0 and EL1 is CONSTRAINED UNPREDICTABLE, and one of the following must happen:</p> <ul style="list-style-type: none"> • The number of counters accessible is an UNKNOWN non-zero value less than PMCR.N. • There is no access to any counters. <p>For reads of HDCR.HPMN by EL2 or higher, if this field is set to 0 or to a value larger than PMCR.N, the processor must return a CONSTRAINED UNPREDICTABLE value being one of:</p> <ul style="list-style-type: none"> • PMCR.N. • The value that was written to HDCR.HPMN. • (The value that was written to HDCR.HPMN) modulo $2h$, where h is the smallest number of bits required for a value in the range 0 to PMCR.N. <p>This field resets to $0x6$.</p>

To access the HDCR:

```
MRC p15,4,<Rt>,c1,c1,1 ; Read HDCR into Rt
MCR p15,4,<Rt>,c1,c1,1 ; Write Rt to HDCR
```

4.5.39 Hyp Architectural Feature Trap Register

The HCPTR characteristics are:

Purpose Controls trapping to Hyp mode of Non-secure access, at EL1 or lower, to coprocessors other than CP14 and CP15 and to floating-point and Advanced SIMD functionality. Also controls access from Hyp mode to this functionality.

Usage constraints This register is accessible as follows:

EL0 (NS)	EL0 (S)	EL1 (NS)	EL1 (S)	EL2	EL3 (SCR.NS = 1)	EL3 (SCR.NS = 0)
-	-	-	-	RW	RW	-

If a bit in the NSACR prohibits a Non-secure access, then the corresponding bit in the HCPTR behaves as RAO/WI for Non-secure accesses. See the bit description for TASE.

Configurations HCPTR is architecturally mapped to AArch64 register CPTR_EL2.

Attributes HCPTR is a 32-bit register.

Figure 4-110 shows the HCPTR bit assignments.

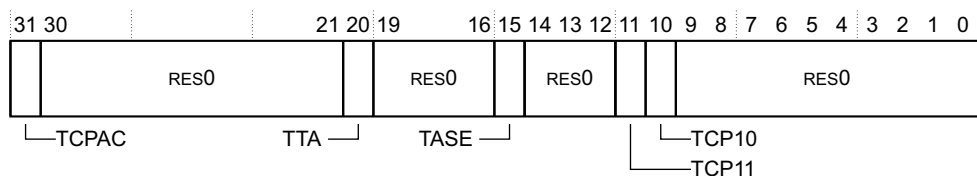

Figure 4-110 HCPTR bit assignments

Table 4-205 shows the HCPTR bit assignments.

Table 4-205 HCPTR bit assignments

Bits	Name	Function
[31]	TCPAC	Trap CPACR accesses. The possible values of this bit are: 0 Has no effect on CPACR accesses. 1 Trap valid Non-secure EL1 CPACR accesses to Hyp mode. When this bit is set to 1, any valid Non-secure EL1 access to the CPACR is trapped to Hyp mode. Resets to 0.
[30:21]	-	Reserved, RES0.
[20]	TTA	Trap Trace Access. Not implemented. RES0.
[19:16]	-	Reserved, RES0.
[15]	TASE	Trap Advanced SIMD use: 0 If the NSACR settings permit Non-secure use of the Advanced SIMD functionality then Hyp mode can access that functionality, regardless of any settings in the CPACR. This bit value has no effect on possible use of the Advanced SIMD functionality from Non-secure EL1 and EL0 modes. 1 Trap valid Non-secure accesses to Advanced SIMD functionality to Hyp mode. If Advanced SIMD and Floating-point are not implemented, this bit is RAO/WI. If NSACR.NSASEDIS is set to 1, then on Non-secure accesses to the HCPTR, the TASE bit behaves as RAO/WI.
[14:12]	-	Reserved, RES0.
[11]	TCP11 ^a	Trap CP11. The possible values of each of this bit is: 0 If NSACR.cp11 is set to 1, then Hyp mode can access CP11, regardless of the value of CPACR.cp11. This bit value has no effect on possible use of CP11 from Non-secure EL1 and EL0 modes. 1 Trap valid Non-secure accesses to CP11 to Hyp mode. Any otherwise-valid access to CP11 from: <ul style="list-style-type: none"> • A Non-secure EL1 or EL0 state is trapped to Hyp mode. • Hyp mode generates an Undefined Instruction exception, taken in Hyp mode. Resets to 0.
[10]	TCP10 ^a	Trap CP10. The possible values of each of this bit is: 0 If NSACR.cp10 is set to 1, then Hyp mode can access CP10, regardless of the value of CPACR.cp10. This bit value has no effect on possible use of CP10 from Non-secure EL1 and EL0 modes. 1 Trap valid Non-secure accesses to CP10 to Hyp mode. Any otherwise-valid access to CP10 from: <ul style="list-style-type: none"> • A Non-secure EL1 or EL0 state is trapped to Hyp mode. • Hyp mode generates an Undefined Instruction exception, taken in Hyp mode. Resets to 0.
[10:0]	-	Reserved, RES0.

- a. If the TCP11 and TCP10 fields are set to different values, the behavior is the same as if both fields were set to the value of TCP10, in all respects other than the value read back by explicitly reading TCP11.

To access the HCPTR:

MRC p15,4,<Rt>,c1,c1,2 ; Read HCPTR into Rt
MCR p15,4,<Rt>,c1,c1,2 ; Write Rt to HCPTR

4.5.40 Translation Table Base Register 0

The TTBR0 characteristics are:

Purpose Holds the base address of translation table 0, and information about the memory it occupies. This is one of the translation tables for the stage 1 translation of memory accesses from modes other than Hyp mode.

Usage constraints This register is accessible as follows:

EL0 (NS)	EL0 (S)	EL1 (NS)	EL1 (S)	EL2	EL3 (SCR.NS = 1)	EL3 (SCR.NS = 0)
-	-	RW	RW	RW	RW	RW

Used in conjunction with the TTBCR. When the 64-bit TTBR0 format is used, cacheability and shareability information is held in the TTBCR and not in TTBR0.

Configurations TTBR0 (NS) is architecturally mapped to AArch64 register TTBR0_EL1. See [Translation Table Base Register 0, EL1 on page 4-79](#).

TTBR0 (S) is mapped to AArch64 register TTBR0_EL3. See [Translation Table Base Register 0, EL3 on page 4-93](#).

There are separate Secure and Non-secure copies of this register.

TTBR0 has write access to the Secure copy of the register disabled when the **CP15SDISABLE** signal is asserted HIGH.

Attributes TTBR0 is:

- A 32-bit register when TTBCR.EAE is 0.
- A 64-bit register when TTBCR.EAE is 1.

There are different formats for this register. TTBCR.EAE determines which format of the register is used. This section describes:

- [TTBR0 format when using the Short-descriptor translation table format](#).
- [TTBR0 format when using the Long-descriptor translation table format on page 4-225](#).

TTBR0 format when using the Short-descriptor translation table format

Figure 4-111 shows the TTBR0 bit assignments when TTBCR.EAE is 0.

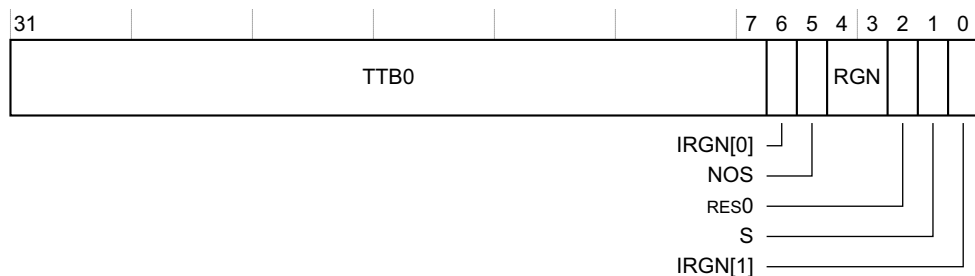

Figure 4-111 TTBR0 bit assignments, TTBCR.EAE is 0

Table 4-206 shows the TTBR0 bit assignments when TTBCR.EAE is 0.

Table 4-206 TTBR0 bit assignments, TTBCR.EAE is 0

Bits	Name	Function
[31:7]	TTB0	Translation table base 0 address, bits[31:x], where x is 14-(TTBCR.N). Bits [x-1:7] are RES0. The value of x determines the required alignment of the translation table, that must be aligned to 2 ^x bytes. If bits [x-1:7] are not all zero, this is a misaligned Translation Table Base Address. Its effects are CONstrained UNPREDICTABLE, where bits [x-1:7] are treated as if all the bits are zero. The value read back from those bits is the value written.
[6]	IRGN[1]	See bit[0] for description of the IRGN field.
[5]	NOS	Not Outer Shareable bit. Indicates the Outer Shareable attribute for the memory associated with a translation table walk that has the Shareable attribute, indicated by TTBR0.S is 1. The possible values are: 0 Outer Shareable. 1 Inner Shareable. This bit is ignored when TTBR0.S is 0.
[4:3]	RGN	Region bits. Indicates the Outer cacheability attributes for the memory associated with the translation table walks. The possible values are: 0b00 Normal memory, Outer Non-cacheable. 0b01 Normal memory, Outer Write-Back Write-Allocate Cacheable. 0b10 Normal memory, Outer Write-Through Cacheable. 0b11 Normal memory, Outer Write-Back no Write-Allocate Cacheable.
[2]	-	Reserved, RES0.
[1]	S	Shareable bit. Indicates the Shareable attribute for the memory associated with the translation table walks. The possible values are: 0 Non-shareable. 1 Shareable.
[0]	IRGN[0]	Inner region bits. Indicates the Inner Cacheability attributes for the memory associated with the translation table walks. The possible values of IRGN[1:0] are: 0b00 Normal memory, Inner Non-cacheable. 0b01 Normal memory, Inner Write-Back Write-Allocate Cacheable. 0b10 Normal memory, Inner Write-Through Cacheable. 0b11 Normal memory, Inner Write-Back no Write-Allocate Cacheable.

To access the TTBR0 when TTBCR.EAE is 0:

```
MRC p15,0,<Rt>,c2,c0,0 ; Read TTBR0 into Rt
MCR p15,0,<Rt>,c2,c0,0 ; Write Rt to TTBR0
```

TTBR0 format when using the Long-descriptor translation table format

Figure 4-112 shows the TTBR0 bit assignments when TTBCR.EAE is 1.

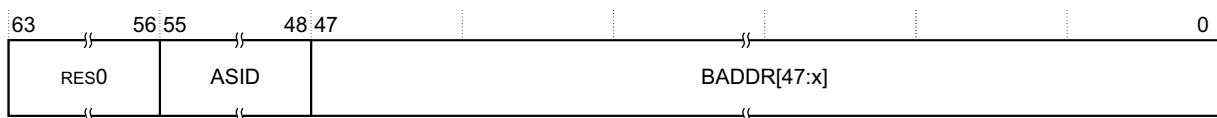

Figure 4-112 TTBR0 bit assignments, TTBCR.EAE is 1

Table 4-207 shows the TTBR0 bit assignments when TTBCR.EAE is 1.

Table 4-207 TTBR0 bit assignments, TTBCR.EAE is 1

Bits	Name	Function
[63:56]	-	Reserved, RES0.
[55:48]	ASID	An ASID for the translation table base address. The TTBCR.A1 field selects either TTBR0.ASID or TTBR1.ASID.
[47:0]	BADDR[47:x]	<p>Translation table base address, bits[47:x]. Bits [x-1:0] are RES0.</p> <p>x is based on the value of TTBCR.T0SZ, and is calculated as follows:</p> <ul style="list-style-type: none"> If TTBCR.T0SZ is 0 or 1, $x = 5 - \text{TTBCR.T0SZ}$. If TTBCR.T0SZ is greater than 1, $x = 14 - \text{TTBCR.T0SZ}$. <p>The value of x determines the required alignment of the translation table, that must be aligned to 2x bytes. If bits [x-1:3] are not all zero, this is a misaligned Translation Table Base Address. Its effects are CONstrained UNPREDICTABLE, where bits [x-1:0] are treated as if all the bits are zero. The value read back from those bits is the value written.</p>

To access the TTBR0 when TTBCR.EAE==1:

```
MRRC p15,0,<Rt>,<Rt2>,c2 ; Read 64-bit TTBR0 into Rt (low word) and Rt2 (high word)
MCRR p15,0,<Rt>,<Rt2>,c2 ; Write Rt (low word) and Rt2 (high word) to 64-bit TTBR0
```

4.5.41 Translation Table Base Register 1

The TTBR1 characteristics are:

Purpose Holds the base address of translation table 1, and information about the memory it occupies. This is one of the translation tables for the stage 1 translation of memory accesses from modes other than Hyp mode.

Usage constraints This register is accessible as follows:

EL0 (NS)	EL0 (S)	EL1 (NS)	EL1 (S)	EL2	EL3 (SCR.NS = 1)	EL3 (SCR.NS = 0)
-	-	RW	RW	RW	RW	RW

Used in conjunction with the TTBCR. When the 64-bit TTBR1 format is used, cacheability and shareability information is held in the TTBCR and not in TTBR1. See [Translation Table Base Control Register on page 4-228](#).

Configurations TTBR1 (NS) is architecturally mapped to AArch64 register TTBR0_EL1. See [Translation Table Base Register 1 on page 4-80](#).

There are separate Secure and Non-secure copies of this register.

Attributes TTBR1 is:

- A 32-bit register when TTBCR.EAE is 0.
- A 64-bit register when TTBCR.EAE is 1.

There are two formats for this register. TTBCR.EAE determines which format of the register is used. This section describes:

- [TTBR1 format when using the Short-descriptor translation table format on page 4-227](#).
- [TTBR1 format when using the Long-descriptor translation table format on page 4-227](#).

TTBR1 format when using the Short-descriptor translation table format

Figure 4-113 shows the TTBR0 bit assignments when TTBCR.EAE is 0.

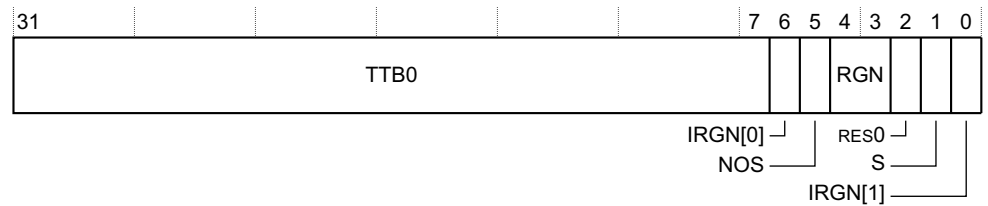

Figure 4-113 TTBR1 bit assignments, TTBCR.EAE is 0

Table 4-208 shows the TTBR1 bit assignments when TTBCR.EAE is 0.

Table 4-208 TTBR1 bit assignments, TTBCR.EAE is 0

Bits	Name	Function
[31:7]	TTB1	Translation table base 1 address, bits[31:x], where x is 14-(TTBCR.N). Bits [x-1:7] are RES0. The translation table must be aligned on a 16KByte boundary. If bits [x-1:7] are not all zero, this is a misaligned Translation Table Base Address. Its effects are CONstrained UNPREDICTABLE, where bits [x-1:7] are treated as if all the bits are zero. The value read back from those bits is the value written.
[6]	-	Reserved, RES0.
[5]	NOS	Not Outer Shareable bit. Indicates the Outer Shareable attribute for the memory associated with a translation table walk that has the Shareable attribute, indicated by TTBR0.S is 1. The possible values are: 0 Outer Shareable. 1 Inner Shareable. This bit is ignored when TTBR0.S is 0.
[4:3]	RGN	Region bits. Indicates the Outer cacheability attributes for the memory associated with the translation table walks. The possible values are: 0b00 Normal memory, Outer Non-cacheable. 0b01 Normal memory, Outer Write-Back Write-Allocate Cacheable. 0b10 Normal memory, Outer Write-Through Cacheable. 0b11 Normal memory, Outer Write-Back no Write-Allocate Cacheable.
[2]	IMP	Reserved, RES0.
[1]	S	Shareable bit. Indicates the Shareable attribute for the memory associated with the translation table walks. The possible values are: 0 Non-shareable. 1 Shareable.
[0]	C	Cacheable bit. Indicates whether the translation table walk is to Inner Cacheable memory. 0 Inner Non-cacheable 1 Inner Cacheable.

To access the TTBR1 when TTBCR.EAE is 0:

MCR p15, 0, <Rt>, c2, c0, 1 ; Read TTBR1 into Rt

MCR p15, 0, <Rt>, c2, c0, 1 ; Write Rt to TTBR1

TTBR1 format when using the Long-descriptor translation table format

Figure 4-114 on page 4-228 shows the TTBR1 bit assignments when TTBCR.EAE is 1.

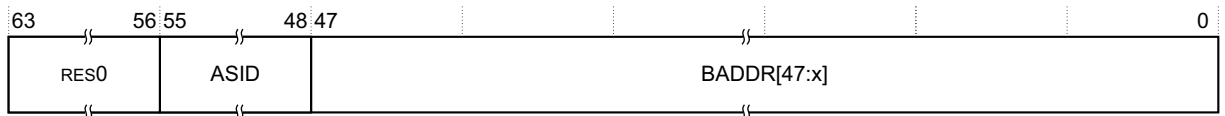

Figure 4-114 TTBR1 bit assignments, TTBCR.EAE is 1

Table 4-209 shows the TTBR1 bit assignments when TTBCR.EAE is 1.

Table 4-209 TTBR1 bit assignments, TTBCR.EAE is 1

Bits	Name	Function
[63:56]	-	Reserved, RES0.
[55:48]	ASID	An ASID for the translation table base address. The TTBCR.A1 field selects either TTBR0.ASID or TTBR1.ASID.
[47:0]	BADDR[47:x]	<p>Translation table base address, bits[47:x]. Bits [x-1:0] are RES0.</p> <p>x is based on the value of TTBCR.T0SZ, and is calculated as follows:</p> <ul style="list-style-type: none"> If TTBCR.T0SZ is 0 or 1, $x = 5 - \text{TTBCR.T0SZ}$. If TTBCR.T0SZ is greater than 1, $x = 14 - \text{TTBCR.T0SZ}$. <p>The value of x determines the required alignment of the translation table, that must be aligned to 2x bytes. If bits [x-1:3] are not all zero, this is a misaligned Translation Table Base Address. Its effects are CONSTRAINED UNPREDICTABLE, where bits [x-1:0] are treated as if all the bits are zero. The value read back from those bits is the value written.</p>

To access the 64-bit TTBR1 when TTBCR.EAE = 1:

MRRC p15, 1, <Rt>, <Rt2>, c2 ; Read 64-bit TTBR1 into Rt (low word) and Rt2 (high word)
 MCRR p15, 1, <Rt>, <Rt2>, c2 ; Write Rt (low word) and Rt2 (high word) to 64-bit TTBR1

4.5.42 Translation Table Base Control Register

The TTBCR characteristics are:

Purpose Determines which of the Translation Table Base Registers defined the base address for a translation table walk required for the stage 1 translation of a memory access from any mode other than Hyp mode. Also controls the translation table format and, when using the Long-descriptor translation table format, holds cacheability and shareability information.

Usage constraints This register is accessible as follows:

EL0 (NS)	EL0 (S)	EL1 (NS)	EL1 (S)	EL2	EL3 (SCR.NS = 1)	EL3 (SCR.NS = 0)
-	-	RW	RW	RW	RW	RW

The processor does not use the implementation-defined bit, TTBCR[30], when using the Long-descriptor translation table format, so this bit is RES0.

Configurations TTBCR (NS) is architecturally mapped to AArch64 register TCR_EL1. See *Translation Control Register, EL1* on page 4-86.

There are separate Secure and Non-secure copies of this register.

Write access to the Secure copy of TTBCR is disabled if the **CP15SDISABLE** signal is asserted HIGH.

Attributes TTBCR is a 32-bit register.

There are two formats for this register. TTBCR.EAE determines which format of the register is used. This section describes:

- *TTBCR format when using the Short-descriptor translation table format.*
- *TTBCR format when using the Long-descriptor translation table format.*

TTBCR format when using the Short-descriptor translation table format

Figure 4-115 shows the TTBCR bit assignments when TTBCR.EAE is 0.

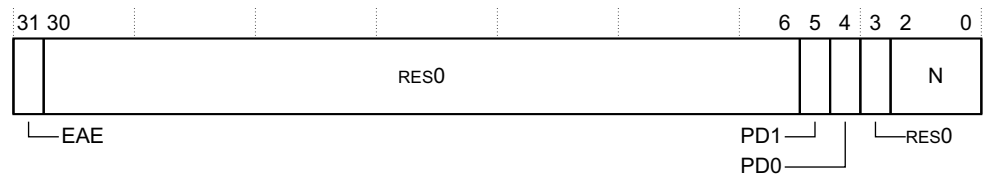

Figure 4-115 TTBCR bit assignments, TTBCR.EAE is 0

Table 4-210 shows the TTBCR bit assignments when TTBCR.EAE is 0.

Table 4-210 TTBCR bit assignments, TTBCR.EAE is 0

Bits	Name	Function
[31]	EAE	Extended Address Enable. 0 Use the 32-bit translation system, with the Short-descriptor translation table format.
[30:6]	-	Reserved,RES0.
[5]	PD1	Translation table walk disable for translations using TTBR1. This bit controls whether a translation table walk is performed on a TLB miss, for an address that is translated using TTBR1. The possible values are: 0 Perform translation table walks using TTBR1. 1 A TLB miss on an address that is translated using TTBR1 generates a Translation fault. No translation table walk is performed.
[4]	PD0	Translation table walk disable for translations using TTBR0. This bit controls whether a translation table walk is performed on a TLB miss for an address that is translated using TTBR0. The possible values are: 0 Perform translation table walks using TTBR0. 1 A TLB miss on an address that is translated using TTBR0 generates a Translation fault. No translation table walk is performed.
[3]	-	Reserved,RES0.
[2:0]	N	Indicate the width of the base address held in TTBR0. In TTBR0, the base address field is bits[31:14-N]. The value of N also determines: <ul style="list-style-type: none"> • Whether TTBR0 or TTBR1 is used as the base address for translation table walks. • The size of the translation table pointed to by TTBR0. N can take any value from 0 to 7, that is, from 0b000 to 0b111. When N has its reset value of 0, the translation table base is compatible with ARMv5 and ARMv6. Resets to 0.

TTBCR format when using the Long-descriptor translation table format

Figure 4-116 on page 4-230 shows the TTBCR bit assignments when TTBCR.EAE is 1.

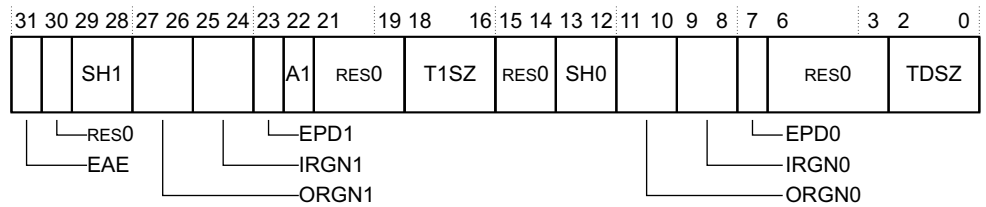

Figure 4-116 TTBCR bit assignments, TTBCR.EAE is 1

Table 4-211 shows the TTBCR bit assignments when TTBCR.EAE is 1.

Table 4-211 TTBCR bit assignments, TTBCR.EAE is 1

Bits	Name	Function
[31]	EAE	Extended Address Enable: 1 Use the 40-bit translation system, with the Long-descriptor translation table format.
[30]	-	Reserved, RES0.
[29:28]	SH1	Shareability attribute for memory associated with translation table walks using TTBR1: 0b00 Non-shareable. 0b10 Outer Shareable. 0b11 Inner Shareable. Other values are reserved. Resets to 0.
[27:26]	ORGN1	Outer cacheability attribute for memory associated with translation table walks using TTBR1: 0b00 Normal memory, Outer Non-cacheable. 0b01 Normal memory, Outer Write-Back Write-Allocate Cacheable. 0b10 Normal memory, Outer Write-Through Cacheable. 0b11 Normal memory, Outer Write-Back no Write-Allocate Cacheable. Resets to 0.
[25:24]	IRGN1	Inner cacheability attribute for memory associated with translation table walks using TTBR1: 0b00 Normal memory, Inner Non-cacheable. 0b01 Normal memory, Inner Write-Back Write-Allocate Cacheable. 0b10 Normal memory, Inner Write-Through Cacheable. 0b11 Normal memory, Inner Write-Back no Write-Allocate Cacheable. Resets to 0.
[23]	EPD1	Translation table walk disable for translations using TTBR1. This bit controls whether a translation table walk is performed on a TLB miss, for an address that is translated using TTBR1: 0 Perform translation table walks using TTBR1. 1 A TLB miss on an address that is translated using TTBR1 generates a Translation fault. No translation table walk is performed.

Table 4-211 TTBCR bit assignments, TTBCR.EAE is 1 (continued)

Bits	Name	Function
[22]	A1	Selects whether TTBR0 or TTBR1 defines the ASID: 0 TTBR0.ASID defines the ASID. 1 TTBR1.ASID defines the ASID.
[21:19]	-	Reserved,RES0.
[18:16]	T1SZ	The size offset of the memory region addressed by TTBR1. The region size is $2^{32-T1SZ}$ bytes. Resets to 0.
[15:14]	-	Reserved,RES0.
[13:12]	SH0	Shareability attribute for memory associated with translation table walks using TTBR0: 0b00 Non-shareable. 0b10 Outer Shareable. 0b11 Inner Shareable. Other values are reserved. Resets to 0.
[11:10]	ORGN0	Outer cacheability attribute for memory associated with translation table walks using TTBR0: 0b00 Normal memory, Outer Non-cacheable. 0b01 Normal memory, Outer Write-Back Write-Allocate Cacheable. 0b10 Normal memory, Outer Write-Through Cacheable. 0b11 Normal memory, Outer Write-Back no Write-Allocate Cacheable. Resets to 0.
[9:8]	IRGN0	Inner cacheability attribute for memory associated with translation table walks using TTBR0: 0b00 Normal memory, Inner Non-cacheable. 0b01 Normal memory, Inner Write-Back Write-Allocate Cacheable. 0b10 Normal memory, Inner Write-Through Cacheable. 0b11 Normal memory, Inner Write-Back no Write-Allocate Cacheable. Resets to 0.
[7]	EPD0	Translation table walk disable for translations using TTBR0. This bit controls whether a translation table walk is performed on a TLB miss, for an address that is translated using TTBR0: 0 Perform translation table walks using TTBR0. 1 A TLB miss on an address that is translated using TTBR0 generates a Translation fault. No translation table walk is performed.
[6:3]	-	Reserved,RES0.
[2:0]	T0SZ	The size offset of the memory region addressed by TTBR0. The region size is $2^{32-T0SZ}$ bytes. Resets to 0.

To access the TTBCR:

MRC p15,0,<Rt>,c2,c0,0 ; Read TTBR0 into Rt
MCR p15,0,<Rt>,c2,c0,0 ; Write Rt to TTBR0

4.5.43 Hyp Translation Control Register

The HTCR characteristics are:

Purpose Controls translation table walks required for the stage 1 translation of memory accesses from Hyp mode, and holds cacheability and shareability information for the accesses.

Usage constraints This register is accessible as follows:

EL0 (NS)	EL0 (S)	EL1 (NS)	EL1 (S)	EL2	EL3 (SCR.NS = 1)	EL3 (SCR.NS = 0)
-	-	-	-	RW	RW	-

Configurations HTCR is architecturally mapped to AArch64 register TCR_EL2. See [Translation Control Register, EL2](#) on page 4-89.

Attributes HTCR is a 32-bit register.

Figure 4-117 shows the HTCR bit assignments.

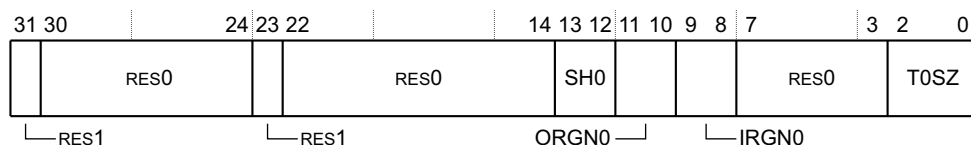

Figure 4-117 HTCR bit assignments

Table 4-212 shows the HTCR bit assignments.

Table 4-212 HTCR bit assignments

Bits	Name	Function
[31]	-	Reserved, RES1.
[30:24]	-	Reserved, RES0.
[23]	-	Reserved, RES1.
[22:14]	-	Reserved, RES0.
[13:12]	SH0	Shareability attribute for memory associated with translation table walks using TTBR0. The possible values are: 0b00 Non-shareable. 0b01 Reserved. 0b10 Outer shareable. 0b11 Inner shareable.
[11:10]	ORGN0	Outer cacheability attribute for memory associated with translation table walks using TTBR0. The possible values are: 0b00 Normal memory, Outer Non-cacheable. 0b01 Normal memory, Outer Write-Back Write-Allocate Cacheable. 0b10 Normal memory, Outer Write-Through Cacheable. 0b11 Normal memory, Outer Write-Back no Write-Allocate Cacheable.
[9:8]	IRGN0	Inner cacheability attribute for memory associated with translation table walks using TTBR0. The possible values are: 0b00 Normal memory, Inner Non-cacheable. 0b01 Normal memory, Inner Write-Back Write-Allocate Cacheable. 0b10 Normal memory, Inner Write-Through Cacheable. 0b11 Normal memory, Inner Write-Back no Write-Allocate Cacheable.
[7:3]	-	Reserved, RES0.
[2:0]	T0SZ	Size offset of the memory region addressed by TTBR0. The region size is $2^{(32-T0SZ)}$ bytes.

The processor does not use the implementation-defined bit, HTCR[30], so this bit is RES0.

To access the HTCR:

MRC p15, 4, <Rt>, c2, c0, 2; Read HTCR into Rt
 MCR p15, 4, <Rt>, c2, c0, 2; Write Rt to HTCR

4.5.44 Virtualization Translation Control Register

The VTCR characteristics are:

Purpose Controls the translation table walks required for the stage 2 translation of memory accesses from Non-secure modes other than Hyp mode, and holds cacheability and shareability information for the accesses.

Usage constraints This register is accessible as follows:

EL0 (NS)	EL0 (S)	EL1 (NS)	EL1 (S)	EL2	EL3 (SCR.NS = 1)	EL3 (SCR.NS = 0)
-	-	-	-	RW	RW	-

Used in conjunction with VTTBR, that defines the translation table base address for the translations.

Configurations VTCR is architecturally mapped to AArch64 register VTCR_EL2. See [Virtualization Translation Control Register, EL2 on page 4-91](#).

This register is accessible only at EL2 or EL3.

Attributes VTCR is a 32-bit register.

Figure 4-118 shows the VTCR bit assignments.

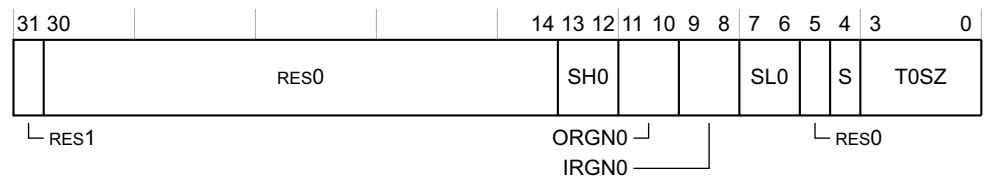

Figure 4-118 VTCR bit assignments

Table 4-213 shows the VTCR bit assignments.

Table 4-213 VTCR bit assignments

Bits	Name	Function
[31]	-	Reserved, RES1.
[30:14]	-	Reserved, RES0.
[13:12]	SH0	Shareability attribute for memory associated with translation table walks using TTBR0. 0b00 Non-shareable. 0b01 Reserved. 0b10 Outer Shareable. 0b11 Inner Shareable.
[11:10]	ORGN0	Outer cacheability attribute for memory associated with translation table walks using TTBR0. 0b00 Normal memory, Outer Non-cacheable. 0b01 Normal memory, Outer Write-Back Write-Allocate Cacheable. 0b10 Normal memory, Outer Write-Through Cacheable. 0b11 Normal memory, Outer Write-Back no Write-Allocate Cacheable.
[9:8]	IRGN0	Inner cacheability attribute for memory associated with translation table walks using TTBR0. 0b00 Normal memory, Inner Non-cacheable. 0b01 Normal memory, Inner Write-Back Write-Allocate Cacheable. 0b10 Normal memory, Inner Write-Through Cacheable. 0b11 Normal memory, Inner Write-Back no Write-Allocate Cacheable.
[7:6]	SLO	Starting level for translation table walks using VTTBR: 0b00 Start at second level. 0b01 Start at first level.
[5]	-	Reserved, RES0.
[4]	S	Sign extension bit. This bit must be programmed to the value of T0SZ[3]. If it is not, then the stage 2 T0SZ value is treated as an UNKNOWN value within the legal range that can be programmed.
[3:0]	T0SZ	The size offset of the memory region addressed by TTBR0. The region size is $2^{32-T0SZ}$ bytes.

To access the VTCR:

MRC p15, 4, <Rt>, c2, c1, 2; Read VTCR into Rt
MCR p15, 4, <Rt>, c2, c1, 2; Write Rt to VTCR

4.5.45 Domain Access Control Register

The DACR characteristics are:

Purpose Defines the access permission for each of the sixteen memory domains.

Usage constraints This register is accessible as follows:

EL0 (NS)	EL0 (S)	EL1 (NS)	EL1 (S)	EL2	EL3 (SCR.NS = 1)	EL3 (SCR.NS = 0)
-	-	RW	RW	RW	RW	RW

Configurations DACR (NS) is architecturally mapped to AArch64 register DACR32_EL2. See [Domain Access Control Register on page 4-92](#).

There are separate Secure and Non-secure copies of this register.

DACR has write access to the Secure copy of the register disabled when the **CP15SDISABLE** signal is asserted HIGH.

DACR has no function when TTBCR.EAE is set to 1, to select the Long-descriptor translation table format.

Attributes DACR is a 32-bit register.

[Figure 4-119](#) shows the DACR bit assignments.

31	30	29	28	27	26	25	24	23	22	21	20	19	18	17	16	15	14	13	12	11	10	9	8	7	6	5	4	3	2	1	0
D15	D14	D13	D12	D11	D10	D9	D8	D7	D6	D5	D4	D3	D2	D1	D0																

Figure 4-119 DACR bit assignments

[Table 4-214](#) shows the DACR bit assignments.

Table 4-214 DACR bit assignments

Bits	Name	Function
[31:0]	D<n>, bits [2n+1:2n], for n = 0 to 15	Domain n access permission, where n = 0 to 15. Permitted values are: 0b00 No access. Any access to the domain generates a Domain fault. 0b01 Client. Accesses are checked against the permission bits in the translation tables. 0b11 Manager. Accesses are not checked against the permission bits in the translation tables. The value 0b10 is reserved.

To access the DACR:

MRC p15, 0, <Rt>, c3, c0, 0 ; Read DACR into Rt
MCR p15, 0, <Rt>, c3, c0, 0 ; Write Rt to DACR

4.5.46 Hyp System Trap Register

The HSTR characteristics are:

Purpose Controls trapping to Hyp mode of Non-secure accesses, at EL1 or lower, of use of T32EE, or the CP15 primary registers, {c0-c3,c5-c13,c15}.

Usage constraints This register is accessible as follows:

EL0 (NS)	EL0 (S)	EL1 (NS)	EL1 (S)	EL2	EL3 (SCR.NS = 1)	EL3 (SCR.NS = 0)
-	-	-	-	RW	RW	-

Configurations HSTR is architecturally mapped to AArch64 register HSTR_EL2. This register is accessible only at EL2 or EL3.

Attributes HSTR is a 32-bit register.

Figure 4-120 shows the HSTR bit assignments.

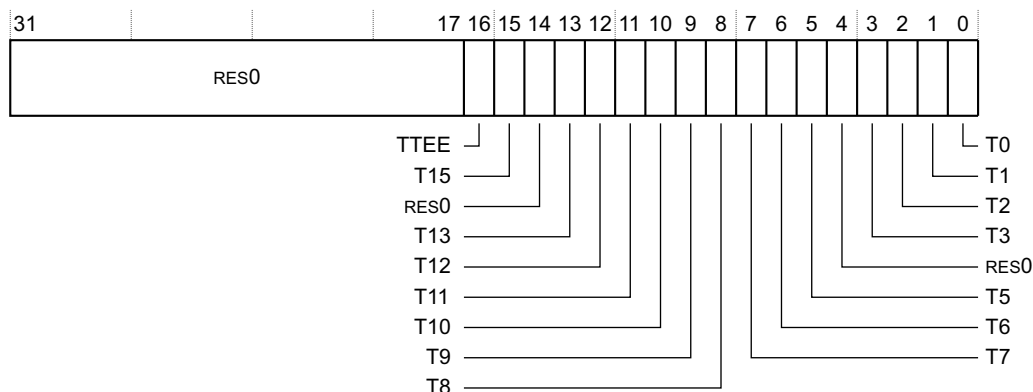

Figure 4-120 HSTR bit assignments

Table 4-215 shows the HSTR bit assignments.

Table 4-215 HSTR bit assignments

Bits	Name	Function
[31:17]	-	Reserved, RES0.
[16]	TTEE	Trap T32EE. This value is: 0 T32EE is not supported.
[15]	T15	Trap coprocessor primary register CRn = 15. The possible values are: 0 Has no effect on Non-secure accesses to CP15 registers. 1 Trap valid Non-secure accesses to coprocessor primary register CRn = 15 to Hyp mode. The reset value is 0.
[14]	-	Reserved, RES0.
[13]	T13	Trap coprocessor primary register CRn = 13. The possible values are: 0 Has no effect on Non-secure accesses to CP15 registers. 1 Trap valid Non-secure accesses to coprocessor primary register CRn = 13 to Hyp mode. The reset value is 0.
[12]	T12	Trap coprocessor primary register CRn = 12. The possible values are: 0 Has no effect on Non-secure accesses to CP15 registers. 1 Trap valid Non-secure accesses to coprocessor primary register CRn = 12 to Hyp mode. The reset value is 0.
[11]	T11	Trap coprocessor primary register CRn = 11. The possible values are: 0 Has no effect on Non-secure accesses to CP15 registers. 1 Trap valid Non-secure accesses to coprocessor primary register CRn = 11 to Hyp mode. The reset value is 0.
[10]	T10	Trap coprocessor primary register CRn = 10. The possible values are: 0 Has no effect on Non-secure accesses to CP15 registers. 1 Trap valid Non-secure accesses to coprocessor primary register CRn = 10 to Hyp mode. The reset value is 0.

Table 4-215 HSTR bit assignments (continued)

Bits	Name	Function
[9]	T9	Trap coprocessor primary register CRn = 9. The possible values are: 0 Has no effect on Non-secure accesses to CP15 registers. 1 Trap valid Non-secure accesses to coprocessor primary register CRn = 9 to Hyp mode. The reset value is 0.
[8]	T8	Trap coprocessor primary register CRn = 8. The possible values are: 0 Has no effect on Non-secure accesses to CP15 registers. 1 Trap valid Non-secure accesses to coprocessor primary register CRn = 8 to Hyp mode. The reset value is 0.
[7]	T7	Trap coprocessor primary register CRn = 7. The possible values are: 0 Has no effect on Non-secure accesses to CP15 registers. 1 Trap valid Non-secure accesses to coprocessor primary register CRn = 7 to Hyp mode. The reset value is 0.
[6]	T6	Trap coprocessor primary register CRn = 6. The possible values are: 0 Has no effect on Non-secure accesses to CP15 registers. 1 Trap valid Non-secure accesses to coprocessor primary register CRn = 6 to Hyp mode. The reset value is 0.
[5]	T5	Trap coprocessor primary register CRn = 5. The possible values are: 0 Has no effect on Non-secure accesses to CP15 registers. 1 Trap valid Non-secure accesses to coprocessor primary register CRn = 5 to Hyp mode. The reset value is 0.
[4]	-	Reserved, RES0.
[3]	T3	Trap coprocessor primary register CRn = 3. The possible values are: 0 Has no effect on Non-secure accesses to CP15 registers. 1 Trap valid Non-secure accesses to coprocessor primary register CRn = 3 to Hyp mode. The reset value is 0.
[2]	T2	Trap coprocessor primary register CRn = 2. The possible values are: 0 Has no effect on Non-secure accesses to CP15 registers. 1 Trap valid Non-secure accesses to coprocessor primary register CRn = 2 to Hyp mode. The reset value is 0.
[1]	T1	Trap coprocessor primary register CRn = 1. The possible values are: 0 Has no effect on Non-secure accesses to CP15 registers. 1 Trap valid Non-secure accesses to coprocessor primary register CRn = 1 to Hyp mode. The reset value is 0.
[0]	T0	Trap coprocessor primary register CRn = 0. The possible values are: 0 Has no effect on Non-secure accesses to CP15 registers. 1 Trap valid Non-secure accesses to coprocessor primary register CRn = 0 to Hyp mode. The reset value is 0.

To access the HSTR:

MRC p15, 4, <Rt>, c1, c1, 3 ; Read HSTR into Rt
MCR p15, 4, <Rt>, c1, c1, 3 ; Write Rt to HSTR

4.5.47 Hyp Auxiliary Configuration Register

The processor does not implement HACR, so this register is always RES0.

4.5.48 Data Fault Status Register

The DFSR characteristics are:

Purpose Holds status information about the last data fault.

Usage constraints This register is accessible as follows:

EL0 (NS)	EL0 (S)	EL1 (NS)	EL1 (S)	EL2	EL3 (SCR.NS = 1)	EL3 (SCR.NS = 0)
-	-	RW	RW	RW	RW	RW

Configurations DFSR (NS) is architecturally mapped to AArch64 register ESR_EL1. There are separate Secure and Non-secure copies of this register. There are two formats for this register. The current translation table format determines which format of the register is used.

Attributes DFSR is a 32-bit register.

This section describes:

- [DFSR when using the Short-descriptor translation table format.](#)
- [DFSR when using the Long-descriptor translation table format on page 4-241.](#)

DFSR when using the Short-descriptor translation table format

Figure 4-121 shows the DFSR bit assignments when using the Short-descriptor translation table format.

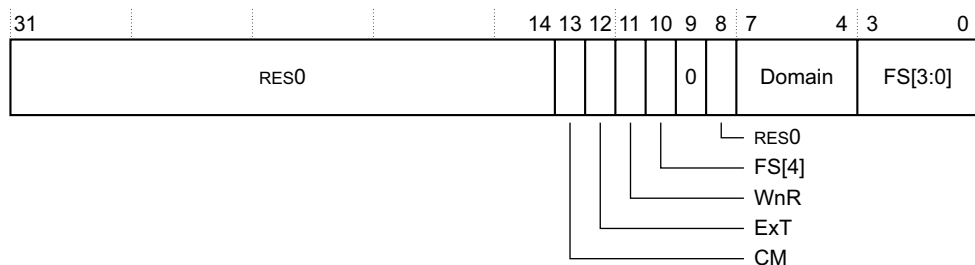

Figure 4-121 DFSR bit assignments for Short-descriptor translation table format

Table 4-216 shows the DFSR bit assignments when using the Short-descriptor translation table format.

Table 4-216 DFSR bit assignments for Short-descriptor translation table format

Bits	Name	Function
[31:14]	-	Reserved, RES0.
[13]	CM	Cache maintenance fault. For synchronous faults, this bit indicates whether a cache maintenance operation generated the fault: 0 Abort not caused by a cache maintenance operation. 1 Abort caused by a cache maintenance operation.
[12]	ExT	External abort type. This field indicates whether an AXI Decode or Slave error caused an abort: 0 External abort marked as DECERR. 1 External abort marked as SLVERR. For aborts other than external aborts this bit always returns 0.
[11]	WnR	Write not Read bit. This field indicates whether the abort was caused by a write or a read access: 0 Abort caused by a read access. 1 Abort caused by a write access. For faults on CP15 cache maintenance operations, including the VA to PA translation operations, this bit always returns a value of 1.
[10]	FS[4]	Part of the Fault Status field. See bits [3:0] in this table.
[9]	-	RAZ.
[8]	-	Reserved, RES0.
[7:4]	Domain	Specifies which of the 16 domains, D15-D0, was being accessed when a data fault occurred. For permission faults that generate Data Abort exception, this field is UNKNOWN. ARMv8 deprecates any use of the domain field in the DFSR.
[3:0]	FS[3:0]	Fault Status bits. This field indicates the type of exception generated. Any encoding not listed is reserved: 0b00001 Alignment fault. 0b00010 Debug event. 0b00011 Access flag fault, section. 0b00100 Instruction cache maintenance fault. 0b00101 Translation fault, section. 0b00110 Access flag fault, page. 0b00111 Translation fault, page. 0b01000 Synchronous external abort, non-translation. 0b01001 Domain fault, section. 0b01011 Domain fault, page. 0b01100 Synchronous external abort on translation table walk, first level. 0b01101 Permission fault, section. 0b01110 Synchronous external abort on translation table walk, second level. 0b01111 Permission fault, second level. 0b10000 TLB conflict abort. 0b10101 LDREX or STREX abort. 0b10110 Asynchronous external abort. 0b11000 Asynchronous parity error on memory access. 0b11001 Synchronous parity error on memory access. 0b11100 Synchronous parity error on translation table walk, first level. 0b11110 Synchronous parity error on translation table walk, second level.

DFSR when using the Long-descriptor translation table format

Figure 4-122 shows the DFSR bit assignments when using the Long-descriptor translation table format.

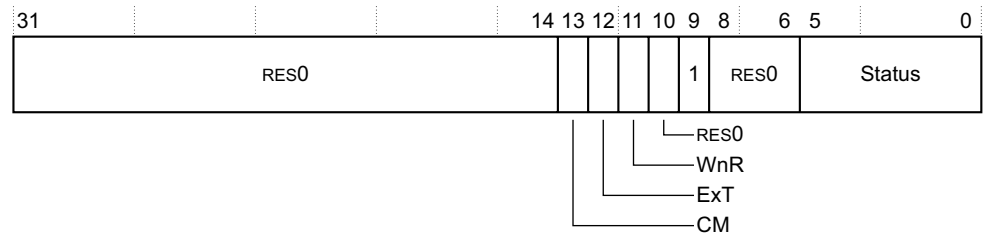

Figure 4-122 DFSR bit assignments for Long-descriptor translation table format

Table 4-217 shows the DFSR bit assignments when using the Long-descriptor translation table format.

Table 4-217 DFSR bit assignments for Long-descriptor translation table format

Bits	Name	Function
[31:14]	-	Reserved, RES0.
[13]	CM	Cache maintenance fault. For synchronous faults, this bit indicates whether a cache maintenance operation generated the fault: 0 Abort not caused by a cache maintenance operation. 1 Abort caused by a cache maintenance operation.
[12]	ExT	External abort type. This field indicates whether an AXI Decode or Slave error caused an abort: 0 External abort marked as DECERR. 1 External abort marked as SLVERR. For aborts other than external aborts this bit always returns 0.
[11]	WnR	Write not Read bit. This field indicates whether the abort was caused by a write or a read access: 0 Abort caused by a read access. 1 Abort caused by a write access. For faults on CP15 cache maintenance operations, including the VA to PA translation operations, this bit always returns a value of 1.
[10]	-	Reserved, RES0.
[9]	-	RAO.
[8:6]	-	Reserved, RES0.
[5:0]	Status	Fault Status bits. This field indicates the type of exception generated. Any encoding not listed is reserved. 0b000000 Address size fault in TTBR0 or TTBR1. 0b0001LL Translation fault, LL bits indicate level. 0b0010LL Access fault flag, LL bits indicate level. 0b0011LL Permission fault, LL bits indicate level. 0b010000 Synchronous external abort. 0b010001 Asynchronous external abort. 0b0101LL Synchronous external abort on translation table walk, LL bits indicate level. 0b011000 Synchronous parity error on memory access. 0b011001 Asynchronous parity error on memory access (DFSR only). 0b0111LL Synchronous parity error on memory access on translation table walk, first level, LL bits indicate level. 0b100001 Alignment fault. 0b100010 Debug event. 0b110000 TLB conflict abort. 0b110101 LDREX or STREX abort.

Table 4-218 shows how the LL bits in the Status field encode the lookup level associated with the MMU fault.

Table 4-218 Encodings of LL bits associated with the MMU fault

Bits	Meaning
0b00	Reserved
0b01	Level 1
0b10	Level 2
0b11	Level 3

To access the DFSR:

MRC p15, 0, <Rt>, c5, c0, 0; Read DFSR into Rt

MCR p15, 0, <Rt>, c5, c0, 0; Write Rt to DFSR

4.5.49 Instruction Fault Status Register

The IFSR characteristics are:

Purpose Holds status information about the last instruction fault.

Usage constraints This register is accessible as follows:

EL0 (NS)	EL0 (S)	EL1 (NS)	EL1 (S)	EL2	EL3 (SCR.NS = 1)	EL3 (SCR.NS = 0)
-	-	RW	RW	RW	RW	RW

Configurations IFSR (NS) is architecturally mapped to AArch64 register IFSR32_EL2. See [Instruction Fault Status Register, EL2 on page 4-98](#).

There are separate Secure and Non-secure copies of this register.

Attributes IFSR is a 32-bit register.

There are two formats for this register. The current translation table format determines which format of the register is used. This section describes:

- [IFSR when using the Short-descriptor translation table format](#).
- [IFSR when using the Long-descriptor translation table format on page 4-244](#).

IFSR when using the Short-descriptor translation table format

Figure 4-123 shows the IFSR bit assignments when using the Short-descriptor translation table format.

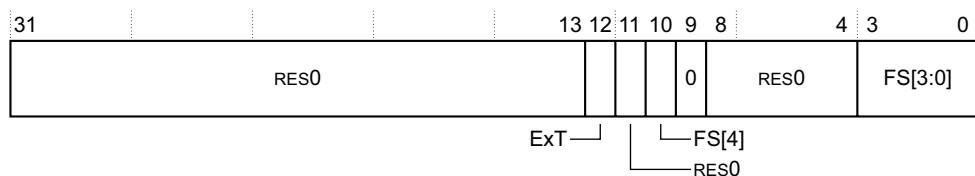

Figure 4-123 IFSR bit assignments for Short-descriptor translation table format

Table 4-219 shows the IFSR bit assignments when using the Short-descriptor translation table format.

Table 4-219 IFSR bit assignments for Short-descriptor translation table format

Bits	Name	Function
[31:13]	-	Reserved, RES0.
[12]	ExT	External abort type. This field indicates whether an AXI Decode or Slave error caused an abort: 0 External abort marked as DECERR. 1 External abort marked as SLVERR. For aborts other than external aborts this bit always returns 0.
[11]	-	Reserved, RES0.
[10]	FS[4]	Part of the Fault Status field. See bits [3:0] in this table.
[9]	-	RAZ.
[8:5]	-	Reserved, RES0.
[4:0]	FS[3:0]	Fault Status bits. This field indicates the type of exception generated. Any encoding not listed is reserved. 0b00010 Debug event. 0b00011 Access flag fault, section. 0b00101 Translation fault, section. 0b00110 Access flag fault, page. 0b00111 Translation fault, page. 0b01000 Synchronous external abort, non-translation. 0b01001 Domain fault, section. 0b01011 Domain fault, page. 0b01100 Synchronous external abort on translation table walk, first level. 0b01101 Permission Fault, Section. 0b01110 Synchronous external abort on translation table walk, second Level. 0b01111 Permission fault, page. 0b10000 TLB conflict abort. 0b11001 Synchronous parity error on memory access. 0b11100 Synchronous parity error on translation table walk, first level. 0b11110 Synchronous parity error on translation table walk, second level.

IFSR when using the Long-descriptor translation table format

Figure 4-124 shows the IFSR bit assignments when using the Long-descriptor translation table format.

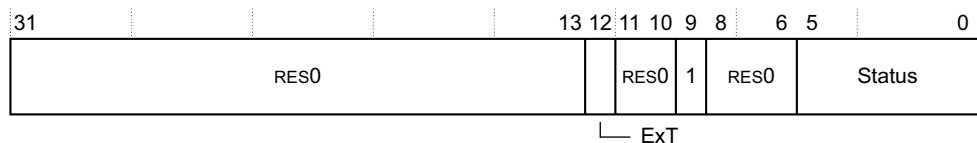

Figure 4-124 IFSR bit assignments for Long-descriptor translation table format

Table 4-220 shows the IFSR bit assignments when using the Long-descriptor translation table format.

Table 4-220 IFSR bit assignments for Long-descriptor translation table format

Bits	Name	Function
[31:13]	-	Reserved, RES0.
[12]	ExT	External abort type. This field indicates whether an AXI Decode or Slave error caused an abort: 0 External abort marked as DECERR. 1 External abort marked as SLVERR. For aborts other than external aborts this bit always returns 0.
[11:10]	-	Reserved, RES0.
[9]	-	RAO.
[8:6]	-	Reserved, RES0.
[5:0]	Status	Fault Status bits. This field indicates the type of exception generated. Any encoding not listed is reserved. 0b000000 Address size fault in TTBR0 or TTBR1. 0b0001LL Translation fault, LL bits indicate level. 0b0010LL Access fault flag, LL bits indicate level. 0b0011LL Permission fault, LL bits indicate level. 0b010000 Synchronous external abort. 0b0101LL Synchronous external abort on translation table walk, LL bits indicate level. 0b011000 Synchronous parity error on memory access. 0b0111LL Synchronous parity error on memory access on translation table walk, LL bits indicate level. 0b100001 Alignment fault. 0b100010 Debug event. 0b110000 TLB conflict abort.

Table 4-221 shows how the LL bits in the Status field encode the lookup level associated with the MMU fault.

Table 4-221 Encodings of LL bits associated with the MMU fault

Bits	Meaning
0b00	Reserved
0b01	Level 1
0b10	Level 2
0b11	Level 3

Note

If a Data Abort exception is generated by an instruction cache maintenance operation when the Long-descriptor translation table format is selected, the fault is reported as a Cache Maintenance fault in the DFSR or HSR with the appropriate Fault Status code. For such exceptions reported in the DFSR, the corresponding IFSR is UNKNOWN.

To access the IFSR:

MRC p15, 0, <Rt>, c5, c0, 1; Read IFSR into Rt
 MCR p15, 0, <Rt>, c5, c0, 1; Write Rt to IFSR

Register access is encoded as follows:

Table 4-222 IFSR access encoding

coproc	opc1	CRn	CRm	opc2
1111	000	0101	0000	001

4.5.50 Auxiliary Data Fault Status Register

The processor does not implement ADFSR, so this register is always RES0.

4.5.51 Auxiliary Instruction Fault Status Register

The processor does not implement AIFSR, so this register is always RES0.

4.5.52 Hyp Auxiliary Data Fault Status Syndrome Register

The processor does not implement HADFSR, so this register is always RES0.

4.5.53 Hyp Auxiliary Instruction Fault Status Syndrome Register

The processor does not implement HAIFSR, so this register is always RES0.

4.5.54 Hyp Syndrome Register

The HSR characteristics are:

Purpose Holds syndrome information for an exception taken to Hyp mode.

Usage constraints This register is accessible as follows:

EL0 (NS)	EL0 (S)	EL1 (NS)	EL1 (S)	EL2	EL3 (SCR.NS = 1)	EL3 (SCR.NS = 0)
-	-	-	-	RW	RW	-

Configurations HSR is architecturally mapped to AArch64 register ESR_EL2. See [Exception Syndrome Register, EL2 on page 4-101](#).

This register is accessible only at EL2 or EL3.

Attributes HSR is a 32-bit register.

[Figure 4-125](#) shows the HSR bit assignments.

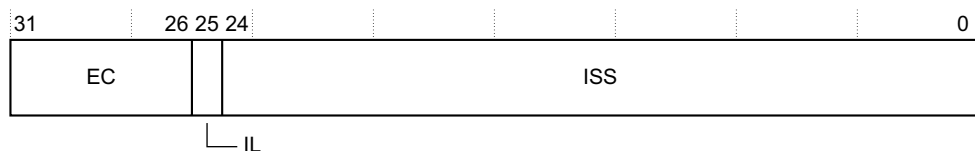

Figure 4-125 HSR bit assignments

Table 4-223 shows the HSR bit assignments.

Table 4-223 HSR bit assignments

Bits	Name	Function
[31:26]	EC	Exception class. The exception class for the exception that is taken in Hyp mode. See the <i>ARM® Architecture Reference Manual ARMv8, for ARMv8-A architecture profile</i> for more information.
[25]	IL	Instruction length. See the <i>ARM® Architecture Reference Manual ARMv8, for ARMv8-A architecture profile</i> for more information.
[24:0]	ISS	Instruction specific syndrome. See the <i>ARM® Architecture Reference Manual ARMv8, for ARMv8-A architecture profile</i> for more information. The interpretation of this field depends on the value of the EC field. See Encoding of ISS[24:20] when HSR[31:30] is 0b00 .

Encoding of ISS[24:20] when HSR[31:30] is 0b00

For EC values that are nonzero and have the two most-significant bits 0b00, ISS[24:20] provides the condition field for the trapped instruction, together with a valid flag for this field. The encoding of this part of the ISS field is:

CV, ISS[24] Condition valid. Possible values of this bit are:

0	The COND field is not valid.
1	The COND field is valid.

When an instruction is trapped, CV is set to 1.

COND, ISS[23:20]

The Condition field for the trapped instruction. This field is valid only when CV is set to 1.

If CV is set to 0, this field is RES0.

When an instruction is trapped, the COND field is set to the condition the instruction was executed with.

4.5.55 Data Fault Address Register

The DFAR characteristics are:

Purpose Holds the virtual address of the faulting address that caused a synchronous Data Abort exception.

Usage constraints This register is accessible as follows:

	EL0 (NS)	EL0 (S)	EL1 (NS)	EL1 (S)	EL2	EL3 (SCR.NS = 1)	EL3 (SCR.NS = 0)
DFAR(S)	-	-	-	RW	-	-	RW
DFAR(NS)	-	-	RW	-	RW	RW	-

Configurations DFAR (NS) is architecturally mapped to AArch64 register FAR_EL1[31:0]. See [Fault Address Register, EL1 on page 4-103](#).

DFAR (S) is architecturally mapped to AArch32 register HDFAR. See [Hyp Data Fault Address Register on page 4-249](#).

DFAR (S) is architecturally mapped to AArch64 register FAR_EL2[31:0]. See *Fault Address Register, EL2* on page 4-104.

Attributes DFAR is a 32-bit register.

Figure 4-126 shows the DFAR bit assignments.

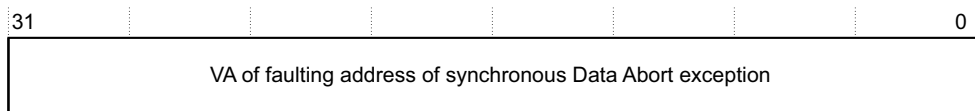

Figure 4-126 DFAR bit assignments

on page 4-104 Table 4-224 shows the DFAR bit assignments.

Table 4-224 DFAR bit assignments

Bits	Name	Function
[31:0]	VA	The Virtual Address of faulting address of synchronous Data Abort exception

To access the DFAR:

MRC p15, 0, <Rt>, c6, c0, 0 ; Read DFAR into Rt

MCR p15, 0, <Rt>, c6, c0, 0 ; Write Rt to DFAR

4.5.56 Instruction Fault Address Register

The IFAR characteristics are:

Purpose Holds the virtual address of the faulting address that caused a synchronous Prefetch Abort exception.

Usage constraints This register is accessible as follows:

	EL0 (NS)	EL0 (S)	EL1 (NS)	EL1 (S)	EL2	EL3 (SCR.NS = 1)	EL3 (SCR.NS = 0)
IFAR(S)	-	-	-	RW	-	-	RW
IFAR(NS)	-	-	RW	-	RW	RW	-

Configurations IFAR (NS) is architecturally mapped to AArch64 register FAR_EL1[63:32]. See *Fault Address Register, EL1* on page 4-103.

IFAR (S) is architecturally mapped to AArch32 register HIFAR.

IFAR (S) is architecturally mapped to AArch64 register FAR_EL2[63:32]. See *Fault Address Register, EL2* on page 4-104.

Attributes IFAR is a 32-bit register.

Figure 4-127 shows the IFAR bit assignments.

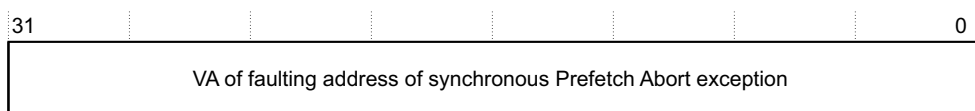

Figure 4-127 IFAR bit assignments

on page 4-104 Table 4-225 shows the IFAR bit assignments.

Table 4-225 IFAR bit assignments

Bits	Name	Function
[31:0]	VA	The Virtual Address of faulting address of synchronous Prefetch Abort exception

To access the IFAR:

MRC p15, 0, <Rt>, c6, c0, 2; Read IFAR into Rt
MCR p15, 0, <Rt>, c6, c0, 2; Write Rt to IFAR

4.5.57 Hyp Data Fault Address Register

The HDFAR characteristics are:

Purpose Holds the virtual address of the faulting address that caused a synchronous Data Abort exception that is taken to Hyp mode.

Usage constraints This register is accessible as follows:

EL0 (NS)	EL0 (S)	EL1 (NS)	EL1 (S)	EL2	EL3 (SCR.NS = 1)
-	-	-	RW	RW	-

An execution in a Non-secure EL1 state, or in Secure state, makes the HDFAR UNKNOWN.

Configurations HDFAR is architecturally mapped to AArch64 register FAR_EL2[31:0] when EL3 is AArch64. See [Fault Address Register, EL2 on page 4-104](#).
HDFAR (S) is architecturally mapped to AArch32 register DFAR (S). See [Data Fault Address Register on page 4-247](#).

Attributes HDFAR is a 32-bit register.

Figure 4-128 shows the HDFAR bit assignments.

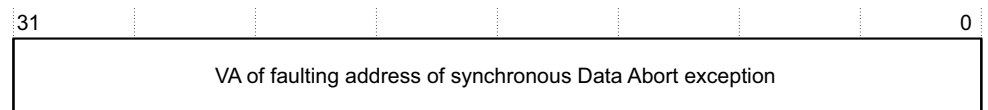

Figure 4-128 HDFAR bit assignments

on page 4-104 Table 4-226 shows the HDFAR bit assignments.

Table 4-226 HDFAR bit assignments

Bits	Name	Function
[31:0]	VA	The Virtual Address of faulting address of synchronous Data Abort exception

To access the HDFAR:

MRC p15, 4, <Rt>, c6, c0, 0; Read HDFAR into Rt
MCR p15, 4, <Rt>, c6, c0, 0; Write Rt to HDFAR

4.5.58 Hyp Instruction Fault Address Register

The HIFAR characteristics are:

Purpose Holds the virtual address of the faulting address that caused a synchronous Prefetch Abort exception that is taken to Hyp mode.

Usage constraints This register is accessible as follows:

EL0 (NS)	EL0 (S)	EL1 (NS)	EL1 (S)	EL2	EL3 (SCR.NS = 1)	EL3 (SCR.NS = 0)
-	-	-	-	RW	RW	-

Execution in any Non-secure mode other than Hyp mode makes HPFAR UNKNOWN.

Configurations HIFAR is architecturally mapped to AArch64 register FAR_EL2[63:32]. See [Fault Address Register, EL2](#) on page 4-104.

HIFAR is architecturally mapped to AArch32 register IFAR (S). See [Instruction Fault Address Register](#) on page 4-248.

Attributes HIFAR is a 32-bit register.

Figure 4-129 shows the HIFAR bit assignments.

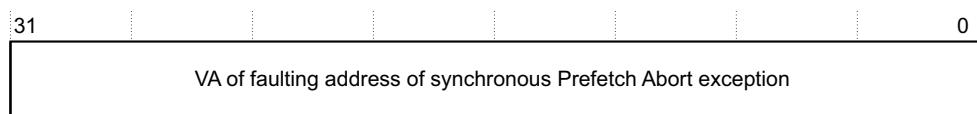

Figure 4-129 HIFAR bit assignments

Table 4-227 shows the HIFAR bit assignments.

Table 4-227 HIFAR bit assignments

Bits	Name	Function
[31:0]	VA	The Virtual Address of faulting address of synchronous Prefetch Abort exception

To access the HIFAR:

MRC p15, 4, <Rt>, c6, c0, 2 ; Read HIFAR into Rt

MCR p15, 4, <Rt>, c6, c0, 2 ; Write Rt to HIFAR

4.5.59 Hyp IPA Fault Address Register

The HPFAR characteristics are:

Purpose Holds the faulting IPA for some aborts on a stage 2 translation taken to Hyp mode.

Usage constraints This register is accessible as follows:

EL0 (NS)	EL0 (S)	EL1 (NS)	EL1 (S)	EL2	EL3 (SCR.NS = 1)	EL3 (SCR.NS = 0)
-	-	-	-	RW	RW	-

Execution in any Non-secure mode other than Hyp mode makes HPFAR UNKNOWN.

Configurations HPFAR is architecturally mapped to AArch64 register HPFAR_EL2[31:0]. See *Hypervisor IPA Fault Address Register, EL2* on page 4-105.

Attributes HPFAR is a 32-bit register.

Figure 4-129 on page 4-250 shows the HPFAR bit assignments.

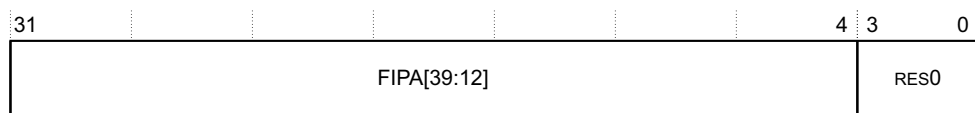

Figure 4-130 HPFAR bit assignments

on page 4-104 Table 4-227 on page 4-250 shows the HPFAR bit assignments.

Table 4-228 HPFAR bit assignments

Bits	Name	Function
[31:4]	FIPA[39:12]	Bits [39:12] of the faulting intermediate physical address
[3:0]	-	Reserved, RES0

To access the HPFAR:

MRC p15, 4, <Rt>, c6, c0, 4 ; Read HPFAR into Rt
MCR p15, 4, <Rt>, c6, c0, 4 ; Write Rt to HPFAR

4.5.60 Physical Address Register

The processor does not use any implementation-defined bits in the 32-bit format or 64-bit format PAR. Bit[8] is RES0. See the *ARM® Architecture Reference Manual ARMv8, for ARMv8-A architecture profile* for more information.

4.5.61 L2 Control Register

The L2CTLR characteristics are:

Purpose Provides IMPLEMENTATION DEFINED control options for the L2 memory system.

Usage constraints This register is accessible as follows:

EL0 (NS)	EL0 (S)	EL1 (NS)	EL1 (S)	EL2	EL3 (SCR.NS = 1)	EL3 (SCR.NS = 0)
-	-	RW	RW	RW	RW	RW

Note

L2CTLR is writeable. However, all writes to this register are ignored.

Configurations L2CTLR is architecturally mapped to the AArch64 L2CTLR_EL1 register. See [L2 Control Register on page 4-106](#).

There is one L2CTLR for the Cortex-A53 processor.

There is one copy of this register that is used in both Secure and Non-secure states.

Attributes L2CTLR is a 32-bit register.

[Figure 4-131](#) shows the L2CTLR bit assignments.

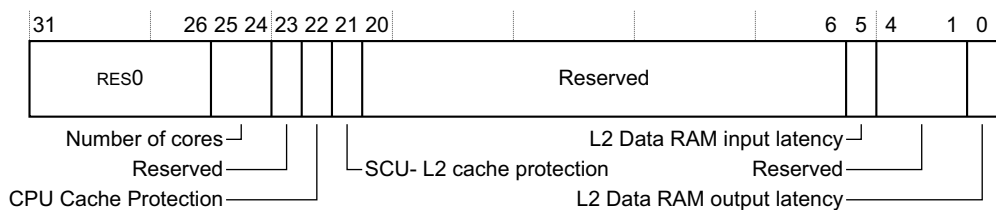

Figure 4-131 L2CTLR bit assignments

Table 4-229 shows the L2CTLR bit assignments.

Table 4-229 L2CTLR bit assignments

Bits	Name	Function
[31:26]	-	Reserved, RES0.
[25:24]	Number of cores	Number of cores present: 0b00 One core, core 0. 0b01 Two cores, core 0 and core 1. 0b10 Three cores, cores 0 to 2. 0b11 Four cores, cores 0 to 3. These bits are read-only and the value of this field is set to the number of cores present in the configuration.
[23]	-	Reserved, RAZ
[22]	CPU Cache Protection	CPU Cache Protection. Core RAMs are implemented: 0 without ECC. 1 with ECC.
[21]	SCU-L2 Cache Protection	SCU-L2 Cache Protection. L2 cache is implemented: 0 without ECC. 1 with ECC. This field is RO.
[20:6]	-	Reserved, RAZ.
[5]	Data RAM input latency	L2 data RAM input latency 0 1-cycle input delay from L2 data RAMs. 1 2-cycle input delay from L2 data RAMs. This field is RO.
[4:1]	-	Reserved, RAZ.
[0]	Data RAM output latency	L2 data RAM output latency: 0 2-cycle output delay from L2 data RAMs. 1 3-cycle output delay from L2 data RAMs. This field is RO.

To access the L2CTLR:

MRC p15, 1, <Rt>, c9, c0, 2; Read L2CTLR into Rt

4.5.62 L2 Extended Control Register

The L2ECTLR characteristics are:

Purpose Provides additional IMPLEMENTATION DEFINED control options for the L2 memory system. This register is used for dynamically changing, but implementation specific, control bits.

Usage constraints This register is accessible as follows:

EL0 (NS)	EL0 (S)	EL1 (NS)	EL1 (S)	EL2	EL3 (SCR.NS = 1)	EL3 (SCR.NS = 0)
-	-	RW	RW	RW	RW	RW

The L2ECTLR can be written dynamically.

Configurations L2ECTLR is architecturally mapped to the AArch64 L2ECTLR_EL1 register. See [L2 Extended Control Register](#) on page 4-107.

There is one copy of this register that is used in both Secure and Non-secure states.

There is one L2ECTLR for the Cortex-A53 processor.

Attributes L2ECTLR is a 32-bit register.

Figure 4-132 shows the L2ECTLR bit assignments.

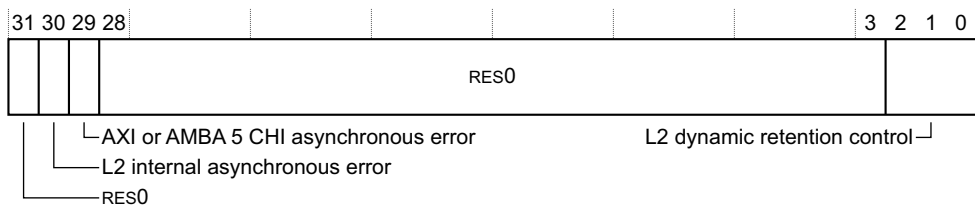

Figure 4-132 L2ECTLR bit assignments

Table 4-230 shows the L2ECTLR bit assignments.

Table 4-230 L2ECTLR bit assignments

Bits	Name	Function
[31]	-	Reserved, RES0.
[30]	L2 internal asynchronous error	L2 internal asynchronous error caused by L2 RAM double-bit ECC error. The possible values are: 0 No pending asynchronous error. This is the reset value. 1 An asynchronous error has occurred. A write of 0 clears this bit. A write of 1 is ignored.
[29]	AXI or CHI asynchronous error	AXI or CHI asynchronous error indication. The possible values are: 0 No pending asynchronous error. 1 An asynchronous error has occurred. A write of 0 clears this bit. A write of 1 is ignored.
[28:3]	-	Reserved, RES0.
[2:0]	L2 dynamic retention control	L2 dynamic retention control. The possible values are: 0b000 L2 dynamic retention disabled. This is the reset value. 0b001 2 Generic Timer ticks required before retention entry. 0b010 8 Generic Timer ticks required before retention entry. 0b011 32 Generic Timer ticks required before retention entry. 0b100 64 Generic Timer ticks required before retention entry. 0b101 128 Generic Timer ticks required before retention entry. 0b110 256 Generic Timer ticks required before retention entry. 0b111 512 Generic Timer ticks required before retention entry.

To access the L2ECTLR:

MRC p15, 1, <Rt>, c9, c0, 3; Read L2ECTLR into Rt
 MCR p15, 1, <Rt>, c9, c0, 3; Write Rt to L2ECTLR

4.5.63 Primary Region Remap Register

The PRRR characteristics are:

Purpose Controls the top level mapping of the TEX[0], C, and B memory region attributes.

Usage constraints This register is accessible as follows:

EL0 (NS)	EL0 (S)	EL1 (NS)	EL1 (S)	EL2	EL3 (SCR.NS = 1)	EL3 (SCR.NS = 0)
-	-	RW	RW	RW	RW	RW

PRRR is not accessible when the Long-descriptor translation table format is in use. See, instead, [Memory Attribute Indirection Registers 0 and 1](#) on page 4-259.

Configurations PRRR (NS) is architecturally mapped to AArch64 register MAIR_EL1[31:0] when TTBCR.EAE is 0.

PRRR (S) is mapped to AArch64 register MAIR_EL3[31:0] when TTBCR.EAE is 0.

There are separate Secure and Non-secure copies of this register.

PRRR has write access to the Secure copy of the register disabled when the **CP15SDISABLE** signal is asserted HIGH.

Attributes PRRR is a 32-bit register when TTBCR.EAE==0.

Figure 4-133 shows the PRRR bit assignments.

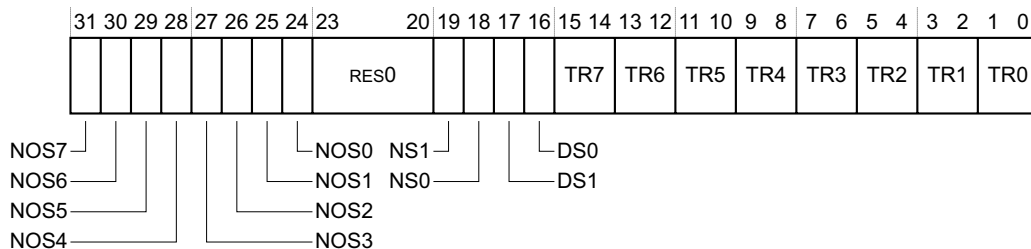

Figure 4-133 PRRR bit assignments

Table 4-231 shows the PRRR bit assignments.

Table 4-231 PRRR bit assignments

Bits	Name	Function
[24+n] ^a	NOS _n	Outer Shareable property mapping for memory attributes <i>n</i> , if the region is mapped as Normal Shareable. <i>n</i> is the value of the TEX[0], C and B bits concatenated. The possible values of each NOS _n bit are: 0 Memory region is Outer Shareable. 1 Memory region is Inner Shareable. The value of this bit is ignored if the region is Normal or Device memory that is not Shareable.
[23:20]	-	Reserved, RES0.
[19]	NS1	Mapping of S = 1 attribute for Normal memory. This bit gives the mapped Shareable attribute for a region of memory that: <ul style="list-style-type: none"> • Is mapped as Normal memory. • Has the S bit set to 1. The possible values of the bit are: 0 Region is not Shareable. 1 Region is Shareable.
[18]	NS0	Mapping of S = 0 attribute for Normal memory. This bit gives the mapped Shareable attribute for a region of memory that: <ul style="list-style-type: none"> • Is mapped as Normal memory. • Has the S bit set to 0. The possible values of the bit are the same as those given for the NS1 bit, bit[19].
[17]	DS1	Mapping of S = 1 attribute for Device memory. This bit gives the mapped Shareable attribute for a region of memory that: <ul style="list-style-type: none"> • Is mapped as Device memory. • Has the S bit set to 1. <p style="text-align: center;">Note</p> This field has no significance in the processor.
[16]	DS0	Mapping of S = 0 attribute for Device memory. This bit gives the mapped Shareable attribute for a region of memory that: <ul style="list-style-type: none"> • Is mapped as Device memory. • Has the S bit set to 0. <p style="text-align: center;">Note</p> This field has no significance in the processor.
[2n+1:2n] ^a	TR _n	Primary TEX mapping for memory attributes <i>n</i> . <i>n</i> is the value of the TEX[0], C and B bits, see Table 4-232 on page 4-258 . This field defines the mapped memory type for a region with attributes <i>n</i> . The possible values of the field are: 0b00 Device (nGnRnE). 0b01 Device (not nGnRnE). 0b10 Normal Memory. 0b11 Reserved, effect is UNPREDICTABLE.

a. Where *n* is 0-7.

Table 4-232 shows the mapping between the memory region attributes and the n value used in the PRRR.nOS n and PRRR.TR n field descriptions.

Table 4-232 Memory attributes and the n value for the PRRR field descriptions

Attributes			n value
TEX[0]	C	B	
0	0	0	0
0	0	1	1
0	1	0	2
0	1	1	3
1	0	0	4
1	0	1	5
1	1	0	6
1	1	1	7

Large physical address translations use Long-descriptor translation table formats and MAIR0 replaces the PRRR, and MAIR1 replaces the NMRR. For more information see [Memory Attribute Indirection Registers 0 and 1](#) on page 4-259.

To access the PRRR:

```
MRC p15, 0, <Rt>, c10, c2, 0 ; Read PRRR into Rt
MCR p15, 0, <Rt>, c10, c2, 0 ; Write Rt to PRRR
```

4.5.64 Memory Attribute Indirection Registers 0 and 1

The MAIR0 and MAIR1 characteristics are:

- Purpose** To provide the memory attribute encodings corresponding to the possible AttrIdx values in a Long-descriptor format translation table entry for stage 1 translations.
- Usage constraints** These registers are accessible as follows:

EL0 (NS)	EL0 (S)	EL1 (NS)	EL1 (S)	EL2	EL3 (SCR.NS = 1)	EL3 (SCR.NS = 0)
-	-	RW	RW	RW	RW	RW

Accessible only when using the Long-descriptor translation table format. When using the Short-descriptor format see, instead, [Primary Region Remap Register on page 4-256](#) and [Normal Memory Remap Register on page 4-262](#).

AttrIdx[2], from the translation table descriptor, selects the appropriate MAIR: setting AttrIdx[2] to 0 selects MAIR0.

The Secure copy of the register gives the value for memory accesses from Secure state.

The Non-secure copy of the register gives the value for memory accesses from Non-secure states other than Hyp mode.

- Configurations** MAIR0 (NS) is architecturally mapped to AArch64 register MAIR_EL1[31:0] when TTBCR.EAE==1. See [Memory Attribute Indirection Register, EL1 on page 4-116](#).
- MAIR0 (S) is mapped to AArch64 register MAIR_EL3[31:0] when TTBCR.EAE==1. See [Memory Attribute Indirection Register, EL3 on page 4-118](#).
- There are separate Secure and Non-secure copies of this register.
- MAIR0 has write access to the Secure copy of the register disabled when the **CP15SDISABLE** signal is asserted HIGH.

- Attributes** MAIR0 is a 32-bit register when TTBCR.EAE==1.

[Figure 4-134](#) shows the MAIR0 and MAIR1 bit assignments.

	31	24 23	16 15	8 7	0
MAIR0	Attr3		Attr2		Attr0
MAIR1	Attr7		Attr6		Attr4

Figure 4-134 MAIR0 and MAIR1 bit assignments

Table 4-233 shows the MAIR0 and MAIR1 bit assignments.

Table 4-233 MAIR0 and MAIR1 bit assignments

Bits	Name	Description
[7:0]	Attr m^a	The memory attribute encoding for an AttrIdx[2:0] entry in a Long descriptor format translation table entry, where: <ul style="list-style-type: none"> AttrIdx[2] selects the appropriate MAIR: <ul style="list-style-type: none"> setting AttrIdx[2] to 0 selects MAIR0. setting AttrIdx[2] to 1 selects MAIR1. AttrIdx[2:0] gives the value of <n> in Attr<n>.

a. Where m is 0-7.

Table 4-234 shows the Attr<n>[7:4] bit assignments.

Table 4-234 Attr<n>[7:4] bit assignments

Bits	Meaning
0b0000	Device memory. See Table 4-235 for the type of Device memory.
0b00RW, RW not 00	Normal Memory, Outer Write-through transient. ^a
0b0100	Normal Memory, Outer Non-Cacheable.
0b01RW, RW not 00	Normal Memory, Outer Write-back transient. ^a
0b10RW	Normal Memory, Outer Write-through non-transient.
0b11RW	Normal Memory, Outer Write-back non-transient.

a. The transient hint is ignored.

Table 4-235 shows the Attr<n>[3:0] bit assignments. The encoding of Attr<n>[3:0] depends on the value of Attr<n>[7:4], as Table 4-235 shows.

Table 4-235 Attr<n>[3:0] bit assignments

Bits	Meaning when Attr<n>[7:4] is 0000	Meaning when Attr<n>[7:4] is not 0000
0b0000	Device-nGnRnE memory	UNPREDICTABLE
0b00RW, RW not 00	UNPREDICTABLE	Normal Memory, Inner Write-through transient
0b0100	Device-nGnRE memory	Normal memory, Inner Non-Cacheable
0b01RW, RW not 00	UNPREDICTABLE	Normal Memory, Inner Write-back transient
0b1000	Device-nGRE memory	Normal Memory, Inner Write-through non-transient (RW=00)
0b10RW, RW not 00	UNPREDICTABLE	Normal Memory, Inner Write-through non-transient
0b1100	Device-GRE memory	Normal Memory, Inner Write-back non-transient (RW=00)
0b11RW, RW not 00	UNPREDICTABLE	Normal Memory, Inner Write-back non-transient

Table 4-236 shows the encoding of the R and W bits that are used, in some Attr<n> encodings in Table 4-234 on page 4-260 and Table 4-235 on page 4-260, to define the read-allocate and write-allocate policies:

Table 4-236 Encoding of R and W bits in some Attrm fields

R or W	Meaning
0	Do not allocate
1	Allocate

To access the MAIR0:

```
MRC p15, 0, <Rt>, c10, c2, 0 ; Read MAIR0 into Rt
MCR p15, 0, <Rt>, c10, c2, 0 ; Write Rt to MAIR0
```

To access the MAIR1:

```
MRC p15, 0, <Rt>, c10, c2, 1 ; Read MAIR1 into Rt
MCR p15, 0, <Rt>, c10, c2, 1 ; Write Rt to MAIR1
```

4.5.65 Normal Memory Remap Register

The NMRR characteristics are:

Purpose Provides additional mapping controls for memory regions that are mapped as Normal memory by their entry in the PRRR.

Usage constraints This register is accessible as follows:

EL0 (NS)	EL0 (S)	EL1 (NS)	EL1 (S)	EL2	EL3 (SCR.NS = 1)	EL3 (SCR.NS = 0)
-	-	RW	RW	RW	RW	RW

The register is:

- Used in conjunction with the PRRR.
- Not accessible when using the Long-descriptor translation table format.

Configurations There are separate Secure and Non-secure copies of this register.

The Non-secure NMRR is architecturally mapped to the AArch64 MAIR_EL1[63:32] register when TTBCR.EAE==0.

The Secure NMRR is mapped to the AArch64 MAIR_EL3[63:32] register when TTBCR.EAE==0.

NMRR has write access to the Secure copy of the register disabled when the CP15SDISABLE signal is asserted HIGH.

NMRR has write access to the Secure copy of the register disabled when the CP15SDISABLE signal is asserted HIGH.

Attributes NMRR is a 32-bit register when TTBCR.EAE is 0.

Figure 4-135 shows the NMRR bit assignments.

31	30	29	28	27	26	25	24	23	22	21	20	19	18	17	16	15	14	13	12	11	10	9	8	7	6	5	4	3	2	1	0
OR7	OR6	OR5	OR4	OR3	OR2	OR1	OR0	IR7	IR6	IR5	IR4	IR3	IR2	IR1	IR0																

Figure 4-135 NMRR bit assignments

Table 4-237 shows the NMRR bit assignments.

Table 4-237 NMRR bit assignments

Bits	Name	Description
$[2n+17:2n+16]^a$	OR n	Outer Cacheable property mapping for memory attributes n , if the region is mapped as Normal memory by the PRRR.TR n entry. n is the value of the TEX[0], C and B bits, see Table 4-232 on page 4-258. The possible values of this field are: 0b00 Region is Non-cacheable. 0b01 Region is Write-Back, Write-Allocate. 0b10 Region is Write-Through, no Write-Allocate. 0b11 Region is Write-Back, no Write-Allocate.
$[2n+1:2n]^a$	IR n	Inner Cacheable property mapping for memory attributes n , if the region is mapped as Normal Memory by the PRRR.TR n entry. n is the value of the TEX[0], C and B bits, see Table 4-232 on page 4-258. The possible values of this field are the same as those given for the OR n field.

a. Where n is 0-7.

To access the NMRR:

MCR p15, 0, <Rt>, c10, c2, 1 ; Read NMRR into Rt
 MCR p15, 0, <Rt>, c10, c2, 1 ; Write Rt to NMRR

4.5.66 Auxiliary Memory Attribute Indirection Register 0

The processor does not implement AMAIR0, so this register is always RES0.

4.5.67 Auxiliary Memory Attribute Indirection Register 1

The processor does not implement AMAIR1, so this register is always RES0.

4.5.68 Hyp Auxiliary Memory Attribute Indirection Register 0

The processor does not implement HAMAIR0, so this register is always RES0.

4.5.69 Hyp Auxiliary Memory Attribute Indirection Register 1

The processor does not implement HAMAIR1, so this register is always RES0.

4.5.70 Vector Base Address Register

The VBAR characteristics are:

Purpose Holds the exception base address for exceptions that are not taken to Monitor mode or to Hyp mode when high exception vectors are not selected.

Usage constraints This register is accessible as follows:

EL0 (NS)	EL0 (S)	EL1 (NS)	EL1 (S)	EL2	EL3 (SCR.NS = 1)	EL3 (SCR.NS = 0)
-	-	RW	RW	RW	RW	RW

Software must program the Non-secure copy of the register with the required initial value as part of the processor boot sequence.

- Configurations** There are separate Secure and Non-secure copies of this register. The Non-secure VBAR is architecturally mapped to the AArch64 VBAR_EL1 register. See [Vector Base Address Register, EL2 on page 4-120](#). The Secure VBAR is mapped to AArch64 register VBAR_EL3[31:0]. See [Vector Base Address Register, EL3 on page 4-121](#). VBAR has write access to the Secure copy of the register disabled when the **CP15SDISABLE** signal is asserted HIGH.

Attributes VBAR is a 32-bit register.

See the *ARM® Architecture Reference Manual ARMv8, for ARMv8-A architecture profile* for more information.

To access the VBAR:

```
MRC p15, 0, <Rt>, c12, c0, 0 ; Read VBAR into Rt
MCR p15, 0, <Rt>, c12, c0, 0 ; Write Rt to VBAR
```

4.5.71 Reset Management Register

The RMR characteristics are:

- Purpose** Controls the execution state that the processor boots into and allows request of a warm reset.
- Usage constraints** This register is accessible as follows:

EL0 (NS)	EL0 (S)	EL1 (NS)	EL1 (S)	EL2	EL3 (SCR.NS = 1)	EL3 (SCR.NS = 0)
-	-	-	-	-	RW	RW

This register is subject to **CP15SDISABLE**, that prevents writing to this register when the **CP15SDISABLE** signal is asserted.

- Configurations** The RMR is architecturally mapped to the AArch64 RMR_EL3 register. There is one copy of this register that is used in both Secure and Non-secure states.
- Attributes** RMR is a 32-bit register.

[Figure 4-136](#) shows the RMR bit assignments.

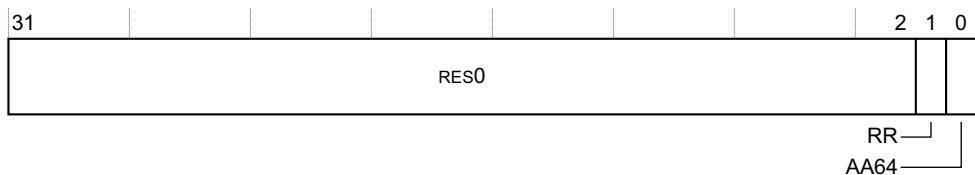

Figure 4-136 RMR bit assignments

Table 4-238 shows the RMR bit assignments.

Table 4-238 RMR bit assignments

Bits	Name	Function
[31:2]	-	Reserved, RES0.
[1]	RR	Reset Request. The possible values are: 0 This is the reset value. 1 Requests a warm reset. This bit is set to 0 by either a cold or warm reset. The bit is strictly a request. The RR bit drives the WARMRSTREQ output signal.
[0]	AA64 ^a	Determines which execution state the processor boots into after a warm reset. The possible values are: 0 AArch32 Execution state. 1 AArch64 Execution state. The reset vector address on reset takes a choice between two values, depending on the value in the AA64 bit. This ensures that even with reprogramming of the AA64 bit, it is not possible to change the reset vector to go to a different location.

a. The cold reset value depends on the **AA64nAA32** signal.

To access the RMR:

MCR p15,0,<Rt>,c12,c0,2 ; Read RMR into Rt
 MCR p15,0,<Rt>,c12,c0,2 ; Write Rt to RMR

Register access is encoded as follows:

Table 4-239 ISR access encoding

coproc	opc1	CRn	CRm	opc2
1111	000	1100	0000	010

4.5.72 Interrupt Status Register

The ISR characteristics are:

Purpose Shows whether an IRQ, FIQ, or external abort is pending. An indicated pending abort might be a physical abort or a virtual abort.

Usage constraints This register is accessible as follows:

EL0 (NS)	EL0 (S)	EL1 (NS)	EL1 (S)	EL2	EL3 (SCR.NS = 1)	EL3 (SCR.NS = 0)
-	-	RO	RO	RO	RO	RO

Configurations ISR is architecturally mapped to AArch64 register ISR_EL1. See [Interrupt Status Register on page 4-123](#).

There is one copy of this register that is used in both Secure and Non-secure states.

Attributes ISR is a 32-bit register.

[Figure 4-137 on page 4-266](#) shows the ISR bit assignments.

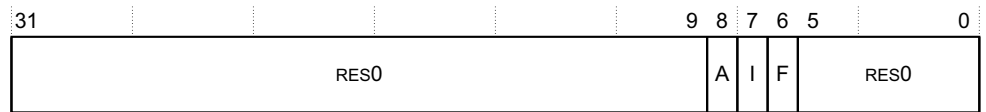

Figure 4-137 ISR bit assignments

Table 4-240 shows the ISR bit assignments.

Table 4-240 ISR bit assignments

Bits	Name	Function
[31:9]	-	Reserved, RES0.
[8]	A	External abort pending bit: 0 No pending external abort. 1 An external abort is pending.
[7]	I	IRQ pending bit. Indicates whether an IRQ interrupt is pending: 0 No pending IRQ. 1 An IRQ interrupt is pending.
[6]	F	FIQ pending bit. Indicates whether an FIQ interrupt is pending: 0 No pending FIQ. 1 An FIQ interrupt is pending.
5:0]	-	Reserved, RES0.

To access the ISR:

MRC p15, 0, <Rt>, c12, c1, 1; Read ISR into Rt

Register access is encoded as follows:

Table 4-241 ISR access encoding

coproc	opc1	CRn	CRm	opc2
1111	000	1100	0001	000

4.5.73 Hyp Vector Base Address Register

The HVBAR characteristics are:

Purpose Holds the exception base address for any exception that is taken to Hyp mode.

Usage constraints This register is accessible as follows:

EL0 (NS)	EL0 (S)	EL1 (NS)	EL1 (S)	EL2	EL3 (SCR.NS = 1)	EL3 (SCR.NS = 0)
-	-	-	-	RW	RW	-

Configurations The HVBAR is:

- Architecturally mapped to the AArch64 VBAR_EL2[31:0]. See [Vector Base Address Register, EL2 on page 4-120](#).

Attributes HVBAR is a 32-bit register.

Figure 4-138 shows the HVBAR bit assignments.

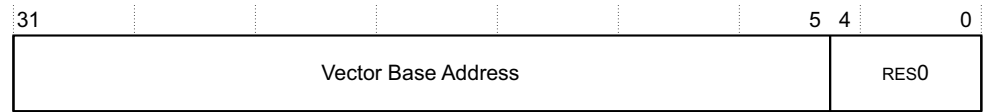

Figure 4-138 HVBAR bit assignments

Table 4-242 shows the HVBAR bit assignments.

Table 4-242 HVBAR bit assignments

Bits	Name	Function
[31:5]	Vector Base Address	Bits[31:5] of the base address of the exception vectors, for exceptions taken in this exception level. Bits[4:0] of an exception vector are the exception offset.
[4:0]	-	Reserved, RES0.

To access the HVBAR:

MRC p15, 4, <Rt>, c12, c0, 0 ; Read HVBAR into Rt
MCR p15, 4, <Rt>, c12, c0, 0 ; Write Rt to HVBAR

4.5.74 FCSE Process ID Register

The processor does not implement *Fast Context Switch Extension* (FCSE), so this register is always RES0.

4.5.75 L2 Auxiliary Control Register

The L2ACTLR characteristics are:

Purpose Provides configuration and control options for the L2 memory system.

Usage constraints This register is accessible as follows:

EL0 (NS)	EL0 (S)	EL1 (NS)	EL1 (S)	EL2	EL3 (SCR.NS = 1)	EL3 (SCR.NS = 0)
-	-	RW	RW	RW	RW	RW

You can write to this register only when the L2 memory system is idle. ARM recommends that you write to this register after a powerup reset before the MMU is enabled and before any ACE, CHI or ACP traffic has begun.

If the register must be modified after a powerup reset sequence, to idle the L2 memory system, you must take the following steps:

1. Disable the MMU from each core followed by an ISB to ensure the MMU disable operation is complete, then followed by a DSB to drain previous memory transactions.
2. Ensure that the system has no outstanding AC channel coherence requests to the Cortex-A53 processor.

- Ensure that the system has no outstanding ACP requests to the Cortex-A53 processor.

When the L2 is idle, the processor can update the L2ACTLR followed by an ISB. After the L2ACTLR is updated, the MMUs can be enabled and normal ACE and ACP traffic can resume.

Configurations There is one copy of this register that is used in both Secure and Non-secure states.

L2ACTLR is mapped to the AArch64 L2ACTLR_EL1 register. See [L2 Auxiliary Control Register](#) on page 4-109.

Attributes L2ACTLR is a 32 bit register.

Figure 4-139 shows the L2ACTLR bit assignments.

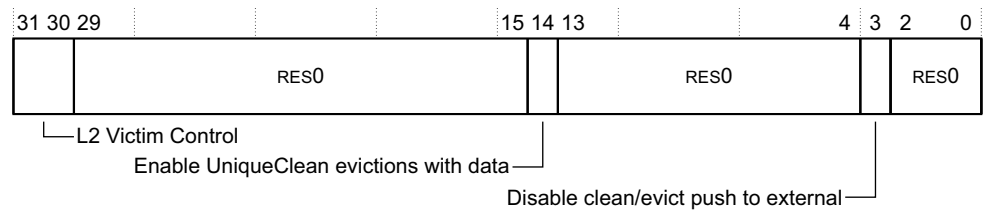

Figure 4-139 L2ACTLR bit assignments

Table 4-243 shows the L2ACTLR bit assignments.

Table 4-243 L2ACTLR bit assignments

Bits	Name	Function
[31:30]	-	L2 victim Control. 0b10 This is the default value. Software must not change it.
[29:15]	-	Reserved, RES0.
[14]	Enable UniqueClean evictions with data	Enables UniqueClean evictions with data. The possible values are: 0 Disables UniqueClean evictions with data. This is the reset value for ACE. 1 Enables UniqueClean evictions with data. This is the reset value for CHI.
[13:4]	-	Reserved, RES0.
[3]	Disable clean/evict push to external	Disables clean/evict push to external. The possible values are: 0 Enables clean/evict to be pushed out to external. This is the reset value for ACE. 1 Disables clean/evict from being pushed to external. This is the reset value for CHI.
[2:0]	-	Reserved, RES0.

To access the L2ACTLR:

MRC p15, 1, <Rt>, c15, c0, 0; Read L2ACTLR into Rt
MCR p15, 1, <Rt>, c15, c0, 0; Write Rt to L2ACTLR

4.5.76 CPU Auxiliary Control Register

The CPUACTLR characteristics are:

Purpose Provides IMPLEMENTATION DEFINED configuration and control options for the processor. There is one 64-bit CPU Auxiliary Control Register for each core in the cluster.

Usage constraints This register is accessible as follows:

EL0 (NS)	EL0 (S)	EL1 (NS)	EL1 (S)	EL2	EL3 (SCR.NS = 1)	EL3 (SCR.NS = 0)
-	-	RW	RW	RW	RW	RW

The CPU Auxiliary Control Register can be written only when the system is idle. ARM recommends that you write to this register after a powerup reset, before the MMU is enabled, and before any ACE or ACP traffic begins.

Note

Setting many of these bits can cause significantly lower performance on your code. Therefore, it is suggested that you do not modify this register unless directed by ARM.

Configurations CPUACTLR is:

- Common to the Secure and Non-secure states.
- Mapped to the AArch64 CPUACTLR_EL1 register. See *CPU Auxiliary Control Register, EL1* on page 4-124.

Attributes CPUACTLR is a 64-bit register.

Figure 4-140 shows the CPUACTLR bit assignments.

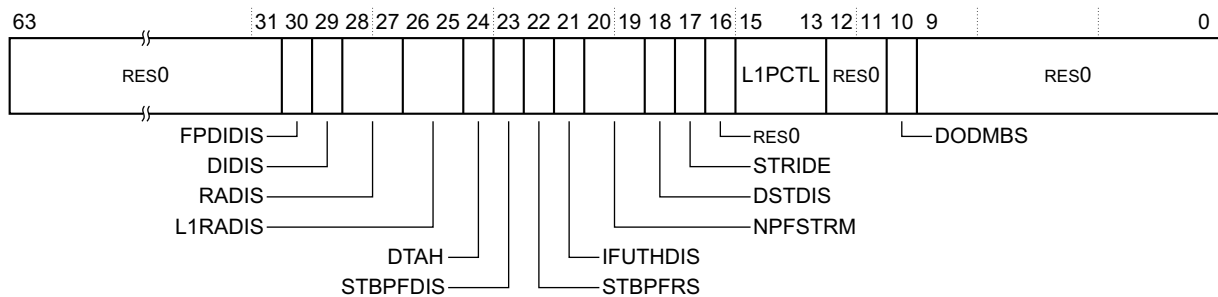

Figure 4-140 CPUACTLR bit assignments

Table 4-244 shows the CPUACTLR bit assignments.

Table 4-244 CPUACTLR bit assignments

Bits	Name	Function
[63:31]	-	Reserved, RES0.
[30]	FPDIDIS	Disable floating-point dual issue. The possible values are: 0 Enable dual issue of floating-point, Advanced SIMD and Cryptography instructions. This is the reset value. 1 Disable dual issue of floating-point, Advanced SIMD and Cryptography instructions.
[29]	DIDIS	Disable Dual Issue. The possible values are: 0 Enable Dual Issue of instructions. This is the reset value. 1 Disable Dual Issue of all instructions.
[28:27]	RADIS	Write streaming no-allocate threshold. The possible values are: 0b00 16th consecutive streaming cache line does not allocate in the L1 or L2 cache. 0b01 128th consecutive streaming cache line does not allocate in the L1 or L2 cache. This is the reset value. 0b10 512th consecutive streaming cache line does not allocate in the L1 or L2 cache. 0b11 Disables streaming. All write-allocate lines allocate in the L1 or L2 cache.
[26:25]	L1RADIS	Write streaming no-L1-allocate threshold. The possible values are: 0b00 4th consecutive streaming cache line does not allocate in the L1 cache. This is the reset value. 0b01 64th consecutive streaming cache line does not allocate in the L1 cache. 0b10 128th consecutive streaming cache line does not allocate in the L1 cache. 0b11 Disables streaming. All write-allocate lines allocate in the L1 cache.
[24]	DTAH	Disable Transient allocation hint. The possible values are: 0 Normal operation. This is the reset value. 1 The Transient allocation hint in the MAIR is ignored and treated the same as non-transient allocation types. The LDNP and STNP instructions in AArch64 behave the same as the equivalent LDP and STP instructions.
[23]	STBPFERS	Disable ReadUnique request for prefetch streams initiated by STB accesses: 0 ReadUnique used for prefetch streams initiated from STB accesses. This is the reset value. 1 ReadShared used for prefetch streams initiated from STB accesses.

Table 4-244 CPUACTLR bit assignments (continued)

Bits	Name	Function
[22]	STBPFDIS	Disable prefetch streams initiated from STB accesses: 0 Enable Prefetch streams initiated from STB accesses. This is the reset value. 1 Disable Prefetch streams initiated from STB accesses.
[21]	IFUTHDIS	IFU fetch throttle disabled. The possible values are: 0 Fetch throttle enabled. This is the reset value. 1 Fetch throttle disabled. This setting increases power consumption.
[20:19]	NPFSTRM	Number of independent data prefetch streams. The possible values are: 0b00 1 stream. 0b01 2 streams. This is the reset value. 0b10 3 streams. 0b11 4 streams.
[18]	DSTDIS	Enable device split throttle. The possible values are: 0 Device split throttle disabled. 1 Device split throttle enabled. This is the reset value.
[17]	STRIDE	Enable stride detection. The possible values are: 0 2 consecutive strides to trigger prefetch. This is the reset value. 1 3 consecutive strides to trigger prefetch.
[16]	-	Reserved, RES0.
[15:13]	L1PCTL	L1 Data prefetch control. The value of the this field determines the maximum number of outstanding data prefetches allowed in the L1 memory system, excluding those generated by software load or PLD instructions. The possible values are: 0b000 Prefetch disabled. 0b001 1 outstanding prefetch allowed. 0b010 2 outstanding prefetches allowed. 0b011 3 outstanding prefetches allowed. 0b100 4 outstanding prefetches allowed. 0b101 5 outstanding prefetches allowed. This is the reset value. 0b110 6 outstanding prefetches allowed. 0b111 8 outstanding prefetches allowed.
[12:11]	-	Reserved, RES0.
[10]	DODMBS	Disable optimized Data Memory Barrier behavior. The possible values are: 0 Enable optimized Data Memory Barrier behavior. This is the reset value. 1 Disable optimized Data Memory Barrier behavior.
[9:0]	-	Reserved, RES0.

To access the CPUACTLR:

MRRC p15, 0, <Rt>, <Rt2>, c15; Read CPU Auxiliary Control Register
MCRW p15, 0, <Rt>, <Rt2>, c15; Write CPU Auxiliary Control Register

4.5.77 CPU Extended Control Register

The CPUECTLR characteristics are:

Purpose Provides additional IMPLEMENTATION DEFINED configuration and control options for the processor.

Usage constraints This register is accessible as follows:

EL0 (NS)	EL0 (S)	EL1 (NS)	EL1 (S)	EL2	EL3 (SCR.NS = 1)	EL3 (SCR.NS = 0)
-	-	RW	RW	RW	RW	RW

The CPUECTLR can be written dynamically.

Configurations The CPUECTLR is:

- Architecturally mapped to the AArch64 CPUECTLR_EL1 register. See *CPU Extended Control Register, EL1* on page 4-128.

Attributes CPUECTLR is a 64-bit register.

Figure 4-141 shows the CPUECTLR bit assignments.

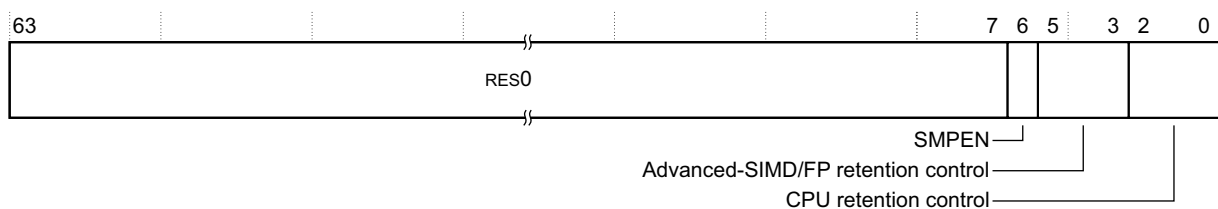

Figure 4-141 CPUECTLR bit assignments

Table 4-245 shows the CPUECTLR bit assignments.

Table 4-245 CPUECTLR bit assignments

Bits	Name	Function
[63:7]	-	Reserved, RES0.
[6]	SMPEN	Enable hardware management of data coherency with other cores in the cluster. The possible values are: 0 Disables data coherency with other cores in the cluster. This is the reset value. 1 Enables data coherency with other cores in the cluster.
Note Set the SMPEN bit before enabling the caches, even if there is only one core in the system.		
[5:3]	FPRECTL	Advanced SIMD and Floating-point retention control. The possible values are: 0b000 Disable the retention circuit. This is the reset value. 0b001 2 Architectural Timer ticks are required before retention entry. 0b010 8 Architectural Timer ticks are required before retention entry. 0b011 32 Architectural Timer ticks are required before retention entry. 0b100 64 Architectural Timer ticks are required before retention entry. 0b101 128 Architectural Timer ticks are required before retention entry. 0b110 256 Architectural Timer ticks are required before retention entry. 0b111 512 Architectural Timer ticks are required before retention entry.
Note This field is present only if the Advanced SIMD and Floating-point Extension is implemented. Otherwise, it is RES0.		
[2:0]	CPURECTL	CPU retention control. The possible values are: 0b000 Disable the retention circuit. This is the reset value. 0b001 2 Architectural Timer ticks are required before retention entry. 0b010 8 Architectural Timer ticks are required before retention entry. 0b011 32 Architectural Timer ticks are required before retention entry. 0b100 64 Architectural Timer ticks are required before retention entry. 0b101 128 Architectural Timer ticks are required before retention entry. 0b110 256 Architectural Timer ticks are required before retention entry. 0b111 512 Architectural Timer ticks are required before retention entry.

To access the CPUECTLR:

MRRC p15, 1, <Rt>, <Rt2>, c15; Read CPU Extended Control Register
 MCRR p15, 1, <Rt>, <Rt2>, c15; Write CPU Extended Control Register

4.5.78 CPU Memory Error Syndrome Register

The CPUMERRSR characteristics are:

Purpose Holds ECC errors on the:

- L1 data RAMs.
- L1 tag RAMs.
- TLB RAMs.

This register is used for recording ECC errors on all processor RAMs.

Usage constraints This register is accessible as follows:

EL0 (NS)	EL0 (S)	EL1 (NS)	EL1 (S)	EL2	EL3 (SCR.NS = 1)	EL3 (SCR.NS = 0)
-	-	RW	RW	RW	RW	RW

Configurations The CPUMERRSR is:

- Architecturally mapped to the AArch64 CPUMERRSR_EL1 register. See *CPU Memory Error Syndrome Register* on page 4-129.
- There is one copy of this register that is used in both Secure and Non-secure states.
- A write of any value to the register updates the register to 0.

Attributes CPUMERRSR is a 64-bit register.

Figure 4-143 on page 4-276 shows the CPUMERRSR bit assignments.

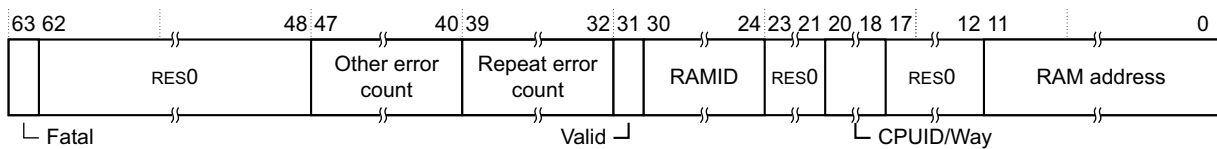

Figure 4-142 CPUMERRSR bit assignments

Table 4-247 on page 4-277 shows the CPUMERRSR bit assignments.

Table 4-246 CPUMERRSR bit assignments

Bits	Name	Function																																																																														
[63]	Fatal	Fatal bit. This bit is set to 1 on the first memory error that caused a data abort. It is a sticky bit so that after it is set, it remains set until the register is written. The reset value is 0.																																																																														
[62:48]	-	Reserved, RES0.																																																																														
[47:40]	Other error count	This field is set to 0 on the first memory error and is incremented on any memory error that does not match the RAMID and Bank/Way information in this register while the sticky Valid bit is set. The reset value is 0.																																																																														
[39:32]	Repeat error count	This field is set to 0 on the first memory error and is incremented on any memory error that exactly matches the RAMID and Bank/Way information in this register while the sticky Valid bit is set. The reset value is 0.																																																																														
[31]	Valid	Valid bit. This bit is set to 1 on the first memory error. It is a sticky bit so that after it is set, it remains set until the register is written. The reset value is 0.																																																																														
[30:24]	RAMID	RAM Identifier. Indicates the RAM in which the first memory error. The possible values are: <table border="0"> <tr> <td>0x00</td> <td>L1 Instruction tag RAM.</td> </tr> <tr> <td>0x01</td> <td>L1 Instruction data RAM.</td> </tr> <tr> <td>0x08</td> <td>L1 Data tag RAM.</td> </tr> <tr> <td>0x09</td> <td>L1 Data data RAM.</td> </tr> <tr> <td>0x0A</td> <td>L1 Data dirty RAM.</td> </tr> <tr> <td>0x18</td> <td>TLB RAM.</td> </tr> </table>	0x00	L1 Instruction tag RAM.	0x01	L1 Instruction data RAM.	0x08	L1 Data tag RAM.	0x09	L1 Data data RAM.	0x0A	L1 Data dirty RAM.	0x18	TLB RAM.																																																																		
0x00	L1 Instruction tag RAM.																																																																															
0x01	L1 Instruction data RAM.																																																																															
0x08	L1 Data tag RAM.																																																																															
0x09	L1 Data data RAM.																																																																															
0x0A	L1 Data dirty RAM.																																																																															
0x18	TLB RAM.																																																																															
[23:21]	-	Reserved, RES0.																																																																														
[20:18]	CPUID/Way	Indicates the RAM where the first memory error occurred. <table border="0"> <tr> <td colspan="2">L1 I-tag RAM</td> <td colspan="2">L1 I-data RAM</td> <td colspan="2">TLB RAM</td> </tr> <tr> <td>0x0</td> <td>Way 0</td> <td>0x0</td> <td>Bank 0</td> <td>0x0</td> <td>Way 0</td> </tr> <tr> <td>0x1</td> <td>Way 1</td> <td>0x1</td> <td>Bank 1</td> <td>0x1</td> <td>Way 1</td> </tr> <tr> <td>0x2-0x7</td> <td>Unused</td> <td>0x2-0x7</td> <td>Unused</td> <td>0x2</td> <td>Way 2</td> </tr> <tr> <td></td> <td></td> <td></td> <td></td> <td>0x3</td> <td>Way 3</td> </tr> <tr> <td></td> <td></td> <td></td> <td></td> <td>0x4-0x7</td> <td>Unused</td> </tr> <tr> <td colspan="2">L1 D-dirty RAM</td> <td colspan="2">L1 D-tag RAM</td> <td colspan="2">L1 D-data RAM</td> </tr> <tr> <td>0x0</td> <td>Dirty RAM</td> <td>0x0</td> <td>Way 0</td> <td>0x0</td> <td>Way0-Bank0</td> </tr> <tr> <td></td> <td></td> <td>0x1</td> <td>Way 1</td> <td>0x1</td> <td>Way0-Bank1</td> </tr> <tr> <td>0x1-0x7</td> <td>Unused</td> <td>0x2</td> <td>Way 2</td> <td>0x2</td> <td>Way1-Bank0</td> </tr> <tr> <td></td> <td></td> <td>0x3</td> <td>Way 3</td> <td>0x3</td> <td>Way1-Bank1</td> </tr> <tr> <td></td> <td></td> <td>0x4-0x7</td> <td>Unused</td> <td>...</td> <td></td> </tr> <tr> <td></td> <td></td> <td></td> <td></td> <td>0x7</td> <td>Way3-Bank1</td> </tr> </table>	L1 I-tag RAM		L1 I-data RAM		TLB RAM		0x0	Way 0	0x0	Bank 0	0x0	Way 0	0x1	Way 1	0x1	Bank 1	0x1	Way 1	0x2-0x7	Unused	0x2-0x7	Unused	0x2	Way 2					0x3	Way 3					0x4-0x7	Unused	L1 D-dirty RAM		L1 D-tag RAM		L1 D-data RAM		0x0	Dirty RAM	0x0	Way 0	0x0	Way0-Bank0			0x1	Way 1	0x1	Way0-Bank1	0x1-0x7	Unused	0x2	Way 2	0x2	Way1-Bank0			0x3	Way 3	0x3	Way1-Bank1			0x4-0x7	Unused	...						0x7	Way3-Bank1
L1 I-tag RAM		L1 I-data RAM		TLB RAM																																																																												
0x0	Way 0	0x0	Bank 0	0x0	Way 0																																																																											
0x1	Way 1	0x1	Bank 1	0x1	Way 1																																																																											
0x2-0x7	Unused	0x2-0x7	Unused	0x2	Way 2																																																																											
				0x3	Way 3																																																																											
				0x4-0x7	Unused																																																																											
L1 D-dirty RAM		L1 D-tag RAM		L1 D-data RAM																																																																												
0x0	Dirty RAM	0x0	Way 0	0x0	Way0-Bank0																																																																											
		0x1	Way 1	0x1	Way0-Bank1																																																																											
0x1-0x7	Unused	0x2	Way 2	0x2	Way1-Bank0																																																																											
		0x3	Way 3	0x3	Way1-Bank1																																																																											
		0x4-0x7	Unused	...																																																																												
				0x7	Way3-Bank1																																																																											
[17:12]		Reserved, RES0.																																																																														
[11:0]	RAM address	Indicates the index address of the first memory error.																																																																														

Note

- A fatal error results in the RAMID, Way, and RAM address recording the fatal error, even if the sticky bit is set.

- Only L1 Data data and L1 Data dirty RAMs can signal fatal errors, because all other RAM instances are protected only by parity.
- If two or more memory errors in the same RAM occur in the same cycle, only one error is reported.
- If two or more first memory error events from different RAMs occur in the same cycle, one of the errors is selected arbitrarily.
- If two or more memory error events from different RAMs, that do not match the RAMID, Way, and index information in this register while the sticky Valid bit is set, occur in the same cycle, then the Other error count field is incremented only by one.

To access the CPUMERRSR:

MRRC p15, 2, <Rt>, <Rt2>, c15; Read CPUMERRSR into Rt and Rt2
 MCRR p15, 2, <Rt>, <Rt2>, c15; Write Rt and Rt2 to CPUMERRSR

4.5.79 L2 Memory Error Syndrome Register

The L2MERRSR characteristics are:

- Purpose** Holds ECC errors on the:
- L2 data RAMs.
 - L2 tag RAMs.
 - SCU snoop filter RAMs.

Usage constraints This register is accessible as follows:

EL0 (NS)	EL0 (S)	EL1 (NS)	EL1 (S)	EL2	EL3 (SCR.NS = 1)	EL3 (SCR.NS = 0)
-	-	RW	RW	RW	RW	RW

- Configurations** The L2MERRSR is:
- Architecturally mapped to the AArch64 L2MERRSR_EL1 register. See [L2 Memory Error Syndrome Register on page 4-132](#).
 - There is one copy of this register that is used in both Secure and Non-secure states.
 - A write of any value to the register updates the register to 0x10000000.

Attributes L2MERRSR is a 64-bit register.

Figure 4-143 shows the L2MERRSR bit assignments.

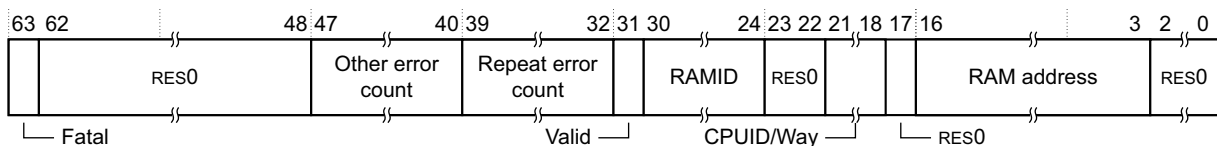

Figure 4-143 L2MERRSR bit assignments

Table 4-247 shows the L2MERRSR bit assignments.

Table 4-247 L2MERRSR bit assignments

Bits	Name	Function																																				
[63]	Fatal	Fatal bit. This bit is set to 1 on the first memory error that caused a data abort. It is a sticky bit so that after it is set, it remains set until the register is written. The reset value is 0.																																				
[62:48]	-	Reserved, RES0.																																				
[47:40]	Other error count	This field is set to 0 on the first memory error and is incremented on any memory error that does not match the RAMID and Bank/Way information in this register while the sticky Valid bit is set. The reset value is 0.																																				
[39:32]	Repeat error count	This field is set to 0 on the first memory error and is incremented on any memory error that exactly matches the RAMID and Bank/Way information in this register while the sticky Valid bit is set. The reset value is 0.																																				
[31]	Valid	Valid bit. This bit is set to 1 on the first memory error. It is a sticky bit so that after it is set, it remains set until the register is written. The reset value is 0.																																				
[30:24]	RAMID	RAM Identifier. Indicates the RAM in which the first memory error occurred. The possible values are: 0x10 L2 tag RAM. 0x11 L2 data RAM. 0x12 SCU snoop filter RAM.																																				
[23:22]	-	Reserved, RES0.																																				
[21:18]	CPUID/Way	Indicates the RAM where the first memory error occurred. <table border="1"> <thead> <tr> <th colspan="2">L2 tag RAM</th> <th colspan="2">L2 data RAM</th> <th colspan="2">SCU snoop filter RAM</th> </tr> </thead> <tbody> <tr> <td>0x0</td> <td>Way 0</td> <td>0x0</td> <td>Bank 0</td> <td>0x0</td> <td>CPU0:Way0</td> </tr> <tr> <td>0x1</td> <td>Way 1</td> <td>0x1</td> <td>Bank 1</td> <td>0x1</td> <td>CPU0:Way1</td> </tr> <tr> <td>...</td> <td></td> <td>...</td> <td></td> <td>...</td> <td></td> </tr> <tr> <td>0xE</td> <td>Way 14</td> <td>0x7</td> <td>Bank 7</td> <td>0xE</td> <td>CPU3:Way2</td> </tr> <tr> <td>0xF</td> <td>Way 15</td> <td>0x8-0xF</td> <td>Unused</td> <td>0xF</td> <td>CPU3:Way3</td> </tr> </tbody> </table>	L2 tag RAM		L2 data RAM		SCU snoop filter RAM		0x0	Way 0	0x0	Bank 0	0x0	CPU0:Way0	0x1	Way 1	0x1	Bank 1	0x1	CPU0:Way1		0xE	Way 14	0x7	Bank 7	0xE	CPU3:Way2	0xF	Way 15	0x8-0xF	Unused	0xF	CPU3:Way3
L2 tag RAM		L2 data RAM		SCU snoop filter RAM																																		
0x0	Way 0	0x0	Bank 0	0x0	CPU0:Way0																																	
0x1	Way 1	0x1	Bank 1	0x1	CPU0:Way1																																	
...																																			
0xE	Way 14	0x7	Bank 7	0xE	CPU3:Way2																																	
0xF	Way 15	0x8-0xF	Unused	0xF	CPU3:Way3																																	
[17]	-	Reserved, RES0.																																				
[16:3]	Index	Indicates the index address of the first memory error.																																				
[2:0]	-	Reserved, RES0.																																				

———— **Note** ————

- A fatal error results in the RAMID, CPU ID/Way and RAM address recording the fatal error, even if the sticky bit was set.
- If two or more memory errors in the same RAM occur in the same cycle, only one error is reported.
- If two or more first memory error events from different RAMs occur in the same cycle, one of the errors is selected arbitrarily, while the Other error count field is incremented only by one.

- If two or more memory error events from different RAMs, that do not match the RAMID, bank, way, or index information in this register while the sticky Valid bit is set, occur in the same cycle, the Other error count field is incremented only by one.

To access the L2MERRSR:

MRRC p15, 3, <Rt>, <Rt2>, c15; Read L2MERRSR into Rt and Rt2

MCRR p15, 3, <Rt>, <Rt2>, c15; Write Rt and Rt2 to L2MERRSR

4.5.80 Configuration Base Address Register

The CBAR characteristics are:

Purpose Holds the physical base address of the memory-mapped GIC CPU interface registers.

Usage constraints This register is accessible as follows:

EL0 (NS)	EL0 (S)	EL1 (NS)	EL1 (S)	EL2	EL3 (SCR.NS = 1)	EL3 (SCR.NS = 0)
-	-	RO	RO	RO	RO	RO

Configurations The CBAR is Common to the Secure and Non-secure states.

Attributes CBAR is a 32-bit register.

Figure 4-144 shows the CBAR bit assignments.

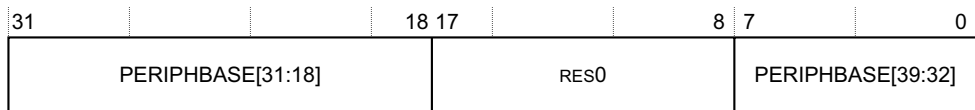

Figure 4-144 CBAR bit assignments

Table 4-248 shows the CBAR bit assignments.

Table 4-248 CBAR bit assignments

Bits	Name	Function
[31:18]	PERIPHBASE[31:18]	The input PERIPHBASE[31:18] determines the reset value.
[17:8]	-	Reserved, RES0.
[7:0]	PERIPHBASE[39:32]	The input PERIPHBASE[39:32] determines the reset value.

To access the CBAR:

MRC p15, 1, <Rt>, c15, c3, 0; Read CBAR into Rt

Chapter 5

Memory Management Unit

This chapter describes the *Memory Management Unit* (MMU). It contains the following sections:

- *About the MMU* on page 5-2.
- *TLB organization* on page 5-3.
- *TLB match process* on page 5-4.
- *External aborts* on page 5-5.

5.1 About the MMU

The Cortex-A53 processor is an ARMv8 compliant processor that supports execution in both the AArch64 and AArch32 states. In AArch32 state, the ARMv8 address translation system resembles the ARMv7 address translation system with LPAE and Virtualization Extensions. In AArch64 state, the ARMv8 address translation system resembles an extension to the Long Descriptor Format address translation system to support the expanded virtual and physical address spaces. For more information regarding the address translation formats, see the *ARM® Architecture Reference Manual ARMv8, for ARMv8-A architecture profile*. Key differences between the AArch64 and AArch32 address translation systems are that the AArch64 state provides:

- A translation granule of 4KB or 64KB. In AArch32, the translation granule is limited to be 4KB.
- A 16-bit ASID. In AArch32, the ASID is limited to an 8-bit value.

The maximum supported physical address size is 40 bits.

You can enable or disable each stage of the address translation, independently.

The MMU controls table walk hardware that accesses translation tables in main memory. The MMU translates virtual addresses to physical addresses. The MMU provides fine-grained memory system control through a set of virtual-to-physical address mappings and memory attributes held in page tables. These are loaded into the *Translation Lookaside Buffer (TLB)* when a location is accessed.

The MMU in each core features the following:

- 10-entry fully-associative instruction micro TLB.
- 10-entry fully-associative data micro TLB.
- 4-way set-associative 512-entry unified main TLB.
- 4-way set-associative 64-entry walk cache.
- 4-way set-associative 64-entry IPA cache.
- The TLB entries include global and application specific identifiers to prevent context switch TLB flushes.
- *Virtual Machine Identifier (VMID)* to prevent TLB flushes on virtual machine switches by the hypervisor.

5.2 TLB organization

This section describes the organization of the TLB.

5.2.1 Micro TLB

The first level of caching for the translation table information is a micro TLB of ten entries that is implemented on each of the instruction and data sides.

All main TLB related maintenance operations affect both the instruction and data micro TLBs, causing them to be flushed.

5.2.2 Main TLB

A unified main TLB handles misses from the micro TLBs. This is a 512-entry, 4-way, set-associative structure. The main TLB supports all VMSAv8 block sizes, except 1GB. If a 1GB block is fetched, it is split into 512MB blocks and the appropriate block for the lookup stored.

Accesses to the main TLB take a variable number of cycles, based on:

- Competing requests from each of the micro TLBs.
- The TLB maintenance operations in flight.
- The different page size mappings in use.

5.2.3 IPA cache RAM

The *Intermediate Physical Address* (IPA) cache RAM holds mappings between intermediate physical addresses and physical addresses. Only Non-secure EL1 and EL0 stage 2 translations use this cache. When a stage 2 translation is completed it is updated, and checked whenever a stage 2 translation is required.

Similarly to the main TLB, the IPA cache RAM can hold entries for different sizes.

5.2.4 Walk cache RAM

The walk cache RAM holds the result of a stage 1 translation up to but not including the last level. If the stage 1 translation results in a section or larger mapping then nothing is placed in the walk cache.

The walk cache holds entries fetched from Secure and Non-secure state.

5.3 TLB match process

The ARMv8-A architecture provides for multiple maps from the VA space, that are translated differently. The TLB entries store all the required context information to facilitate a match and avoid the requirement for a TLB flush on a context or virtual machine switch. Each TLB entry contains a VA, block size, PA, and a set of memory properties that include the memory type and access permissions. Each entry is associated with a particular ASID, or is global for all application spaces. The TLB entry also contains a field to store the VMID in the entry, applicable to accesses made from the Non-secure EL0 and EL1 exception levels. There is also a memory space identifier that records whether the request occurred at the:

- EL3 exception level, if EL3 is AArch64.
- Non-secure EL2 exception level.
- Secure and Non-secure EL0 or EL1 exception levels and EL3 exception level when EL3 is AArch32.

A TLB entry match occurs when the following conditions are met:

- Its VA, moderated by the page size such as the VA bits[47:N], where N is \log_2 of the block size for that translation stored in the TLB entry, matches that of the requested address.
- The memory space matches the memory space state of the requests. The memory space can be one of four values:
 - Secure EL3, when EL3 is AArch64.
 - Non-secure EL2.
 - Secure EL0 or EL1, and EL3 when EL3 is AArch32.
 - Non-secure EL0 or EL1.
- The ASID matches the current ASID held in the CONTEXTIDR, TTBR0, or TTBR1 register or the entry is marked global.
- The VMID matches the current VMID held in the VTTBR register.

Note

- For a request originating from EL2 or AArch64 EL3, the ASID and VMID match are ignored.
 - For a request not originating from Non-secure EL0 or EL1, the VMID match is ignored.
-

5.4 External aborts

External memory aborts are defined as those that occur in the memory system rather than those that the MMU detects. External memory aborts are extremely rare. External aborts are caused by errors flagged by the CHI or AXI interfaces or generated because of an uncorrected ECC error in the L1 Data cache or L2 cache arrays.

See [Secure Configuration Register on page 4-76](#), [Secure Configuration Register on page 4-199](#), or the *ARM® Architecture Reference Manual ARMv8, for ARMv8-A architecture profile*, for more information.

5.4.1 External aborts on data read or write

Externally generated aborts during a data read or write can be asynchronous.

For a load multiple or store multiple operation, the address captured in the fault address register is that of the address that generated the synchronous external abort.

Chapter 6

Level 1 Memory System

This chapter describes the L1 memory system. It contains the following sections:

- *About the L1 memory system* on page 6-2.
- *Cache behavior* on page 6-3.
- *Support for v8 memory types* on page 6-6.
- *L1 Instruction memory system* on page 6-7.
- *L1 Data memory system* on page 6-9.
- *Data prefetching* on page 6-12.
- *Direct access to internal memory* on page 6-13.

6.1 About the L1 memory system

The L1 memory system consists of separate instruction and data caches. The implementer configures the instruction and data caches independently during implementation, to sizes of 8KB, 16KB, 32KB, or 64KB.

The L1 Instruction memory system has the following key features:

- Instruction side cache line length of 64 bytes.
- 2-way set associative L1 Instruction cache.
- 128-bit read interface to the L2 memory system.

The L1 Data memory system has the following features:

- Data side cache line length of 64 bytes.
- 4-way set associative L1 Data cache.
- 256-bit write interface to the L2 memory system.
- 128-bit read interface to the L2 memory system.
- Read buffer that services the *Data Cache Unit (DCU)*, the *Instruction Fetch Unit (IFU)* and the TLB.
- 64-bit read path from the data L1 memory system to the datapath.
- 128-bit write path from the datapath to the L1 memory system.
- Support for three outstanding data cache misses.
- Merging store buffer capability. This handles writes to:
 - Device memory.
 - Normal Cacheable memory.
 - Normal Non-cacheable memory.
- Data side prefetch engine.

6.2 Cache behavior

You cannot disable the L2 and L1 Data caches independently, because they are controlled by the same enable. See [System Control Register on page 4-191](#). On a cache miss, critical word-first filling of the cache is performed.

If the cache reports a hit on a memory location that is marked as Non-Cacheable or Device, this is called an unexpected cache hit. In this architecturally UNPREDICTABLE case, the cache might return incorrect data. Because the caches are physically addressed, improper translation table configuration can create this scenario. Disabling the cache can also create this situation. Non-Cacheable or Device accesses do not lookup in the cache, and therefore ignore any unexpected cache hit.

6.2.1 Instruction cache disabled behavior

If the instruction cache is disabled, fetches cannot access any of the instruction cache arrays. An exception to this rule is the CP15 instruction cache operations. If the instruction cache is disabled, the instruction cache maintenance operations can still execute normally.

If the instruction cache is disabled, all instruction fetches to cacheable memory are treated as if they were non-cacheable. This means that instruction fetches might not be coherent with caches in other cores, and software must take account of this.

6.2.2 Instruction cache speculative memory accesses

Because there can be several unresolved branches in the pipeline, instruction fetches are speculative, meaning there is no guarantee that they are executed. A branch or exceptional instruction in the code stream can cause a pipeline flush, discarding the currently fetched instructions. Because of the aggressive prefetching behavior, you must not place read-sensitive devices in the same page as code. Pages with Device memory type attributes are treated as Non-Cacheable Normal Memory. You must mark pages that contain read-sensitive devices with the translation table descriptor XN (Execute Never) attribute bit. To avoid speculative fetches to read-sensitive devices when address translation is disabled, these devices and code that are fetched must be separated in the physical memory map. See the *ARM® Architecture Reference Manual ARMv8, for ARMv8-A architecture profile* for more information.

6.2.3 Data cache disabled behavior

If the data cache is disabled, loads and store instructions do not access any of the L2 or L1 Data cache arrays. An exception to this rule is the CP15 data cache operations. If the data cache is disabled, the data cache maintenance operations can still execute normally.

If the data cache is disabled, all loads and store instructions to cacheable memory are treated as if they were non-cacheable. This means that they are not coherent with the caches in this core or the caches in other cores, and software must take account of this.

6.2.4 Data cache maintenance considerations

DCIMVAC operations in AArch32 and DC IVAC instructions in AArch64 perform an invalidate of the target address. If the data is dirty in the executing core then a clean is performed before the invalidate.

DCISW operations in AArch32 and DC ISW instructions in AArch64 perform both a clean and invalidate of the target set/way. The values of HCR.SWIO and HCR_EL2.SWIO have no effect.

6.2.5 Data cache coherency

The Cortex-A53 processor uses the MOESI protocol to maintain data coherency between multiple cores.

MOESI describes the state that a shareable line in a L1 Data cache can be in:

- M** Modified/*UniqueDirty* (UD). The line is in only this cache and is dirty.
- O** Owned/*SharedDirty* (SD). The line is possibly in more than one cache and is dirty.
- E** Exclusive/*UniqueClean* (UC). The line is in only this cache and is clean.
- S** Shared/*SharedClean* (SC). The line is possibly in more than one cache and is clean.
- I** Invalid/*Invalid* (I). The line is not in this cache.

The DCU stores the MOESI state of the cache line in the tag and dirty RAMs.

Note

Data coherency is enabled only when the CPUECTLR.SMPEN bit is set. You must set the SMPEN bit before enabling the data cache. If you do not, then the cache is not coherent with other cores and data corruption could occur.

Read allocate mode

The L1 Data cache supports only a Write-Back policy. It normally allocates a cache line on either a read miss or a write miss, although you can alter this by changing the inner cache allocation hints in the page tables.

However, there are some situations where allocating on writes is not wanted, such as executing the C standard library `memset()` function to clear a large block of memory to a known value. Writing large blocks of data like this can pollute the cache with unnecessary data. It can also waste power and performance if a linefill must be performed only to discard the linefill data because the entire line was subsequently written by the `memset()`.

To prevent this, the BIU includes logic to detect when a full cache line has been written by the processor before the linefill has completed. If this situation is detected on a threshold number of consecutive linefills, it switches into read allocate mode.

When in read allocate mode, loads behave as normal and can still cause linefills, and writes still lookup in the cache but, if they miss, they write out to L2 rather than starting a linefill.

Note

More than the specified number of linefills might be observed on the ACE or CHI master interface, before the BIU detects that three full cache lines have been written and switches to read allocate mode.

The BIU continues in read allocate mode until it detects either a cacheable write burst to L2 that is not a full cache line, or there is a load to the same line as is currently being written to L2.

A secondary read allocate mode applies when the L2 cache is integrated. After a threshold number of consecutive cache line sized writes to L2 are detected, L2 read allocate mode is entered.

When in L2 read allocate mode, loads behave as normal and can still cause linefills, and writes still lookup in the cache but, if they miss, they write out to L3 rather than starting a linefill. L2 read allocate mode continues until there is a cacheable write burst that is not a full cache line, or there is a load to the same line as is currently being written to L3.

In AArch64, CPUACTLR_EL1.L1RADIS configures the L1 read allocate mode threshold, and CPUACTLR_EL2.RADIS configures the L2 read allocate mode threshold. See [CPU Auxiliary Control Register, EL1 on page 4-124](#).

In AArch32, CPUACTLR.L1RADIS configures the L1 read allocate mode threshold, and CPUACTLR.RADIS configures the L2 read allocate mode threshold. See [CPU Auxiliary Control Register on page 4-269](#).

Data cache invalidate on reset

The ARMv8-A architecture does not support an operation to invalidate the entire data cache. If this function is required in software, it must be constructed by iterating over the cache geometry and executing a series of individual invalidate by set/way instructions.

The Cortex-A53 processor automatically invalidates caches on reset unless suppressed with the **DBGL1RSTDISABLE** or **L2RSTDISABLE** pins. It is therefore not necessary for software to invalidate the caches on startup.

6.3 Support for v8 memory types

The ARMv8-A architecture introduces several new memory types in place of the ARMv7 Device and Strongly-Ordered memory types. These relate to the following attributes:

- G** Gathering. The capability to gather and merge requests together into a single transaction.
- R** Reordering. The capability to reorder transactions.
- E** Early-acknowledge. The capability to accept early acknowledge of transactions from the interconnect.

Table 6-1 describes the ARMv8 memory types.

Table 6-1 ARMv8 memory types

Memory type	Comment
GRE	Similar to <i>Normal</i> non-cacheable, but does not permit speculative accesses.
nGRE	Treated as nGnRE inside the Cortex-A53 processor, but can be reordered by the external interconnect.
nGnRE	Corresponds to <i>Device</i> in ARMv7.
nGnRnE	Corresponds to <i>Strongly Ordered</i> in ARMv7. Treated the same as nGnRE inside a Cortex-A53 processor, but reported differently on AxCACHE .

As defined by the architecture, these bits apply only when the translation table is marked as ARMv8 Device memory, they do not apply to Normal memory. If an ARMv7 architecture operating system runs on a Cortex-A53 processor, the Device memory type matches the nGnRE encoding and the Strongly-Ordered memory type matches the nGnRnE memory type.

6.4 L1 Instruction memory system

The L1 Instruction side memory system is responsible for providing an instruction stream to the DPU. To increase overall performance and to reduce power consumption, it contains the following functionality:

- Dynamic branch prediction.
- Instruction caching.

6.4.1 Enabling program flow prediction

Program flow prediction is always enabled when the MMU is enabled by enabling the appropriate control bit in the relevant system control register.

6.4.2 Program flow prediction

The following sections describe program flow prediction:

- *Predicted and non-predicted instructions.*
- *T32 state conditional branches.*
- *Return stack predictions.*

Predicted and non-predicted instructions

This section shows the instructions that the processor predicts. Unless otherwise specified, the list applies to A64, A32 and T32 instructions. As a general rule, the flow prediction hardware predicts all branch instructions regardless of the addressing mode, including:

- Conditional branches.
- Unconditional branches.
- Indirect branches associated with procedure call and return instructions.
- Branches that switch between A32 and T32 states.

However, some branch instructions are not predicted:

- Data-processing instructions using the PC as a destination register.
- The BXJ instruction.
- Exception return instructions.

T32 state conditional branches

A T32 instruction set branch that is normally encoded as unconditional can be made conditional by inclusion in an *If-Then* (IT) block. Then it is treated as a conditional branch.

Return stack predictions

The return stack stores the address and, in AArch32, the A32 or T32 instruction set of the instruction after a procedure call type branch instruction. This address is equal to the link register value stored in r14 in AArch32 state or X30 in AArch64 state. The following instructions cause a return stack push if predicted:

- BL.
- BLX (immediate) in AArch32 state.
- BLX (register) in AArch32 state.
- BLR in AArch64 state.

In AArch32 state, the following instructions cause a return stack pop if predicted:

- BX

- LDR pc, [r13], #imm
- LDM r13, {...pc}
- LDM r13, {...pc}!

In AArch64 state, the RET instruction causes a return stack pop.

Because return-from-exception instructions can change processor privilege mode and security state, they are not predicted. This includes:

- LDM (exception return)
- RFE
- SUBS pc, 1r
- ERET

6.5 L1 Data memory system

The L1 Data cache is organized as a physically indexed and physically tagged cache. The micro TLB produces the physical address from the virtual address before performing the cache access.

6.5.1 Internal exclusive monitor

The Cortex-A53 processor L1 memory system has an internal exclusive monitor. This is a 2-state, open and exclusive, state machine that manages Load-Exclusive or Store-Exclusive accesses and Clear-Exclusive (CLREX) instructions. You can use these instructions to construct semaphores, ensuring synchronization between different processes running on the core, and also between different cores that are using the same coherent memory locations for the semaphore. A Load-Exclusive instruction tags a small block of memory for exclusive access. The size of the tagged block is defined by CTR.ERG as 16 words, one cache line.

Note

A load/store exclusive instruction is any one of the following:

- In the A64 instruction set, any instruction that has a mnemonic starting with LDX, LDAX, STX, or STLX.
 - In the A32 and T32 instruction sets, any instruction that has a mnemonic starting with LDREX, STREX, LDAEX, or STLEX.
-

A Load-Exclusive instruction that causes a transaction with **ARLOCKM** for ACE, or **Excl** for CHI, set to HIGH is expected to receive an **EXOKAY** response. An **OKAY** response to a transaction with **ARLOCKM** for ACE, or **Excl** for CHI, set to HIGH indicates that exclusive accesses are not supported at the address of the transaction and causes a Data Abort exception to be taken with a Data Fault Status Code of:

- 0b110101, when using the long descriptor format.
- 0b10101, when using the short descriptor format.

A Load-Exclusive instruction causes **ARLOCKM** for ACE or **Excl** for CHI, to be set to HIGH if the memory attributes are:

- Device.
- Inner Non-cacheable and Outer Non-cacheable.
- Inner Write-Back, Outer Write-Back, Outer Shareable, and **BROADCASTOUTER** is set to HIGH.
- Inner Write-Back, Outer Write-Back, Inner Shareable, and **BROADCASTINNER** is set to HIGH.
- Inner is not Write-Back or Outer is not Write-Back, and Inner Shareable.
- Inner is not Write-Back or Outer is not Write-Back, and Outer Shareable.

Treatment of intervening STR operations

In cases where there is an intervening store operation between an exclusive load and an exclusive store from the same core, the intermediate store does not produce any direct effect on the internal exclusive monitor. The local monitor is in the Exclusive Access state after the exclusive load, remains in the Exclusive Access state after the store, and returns to the Open Access state only after the exclusive store, a CLREX instruction, or an exception return.

However, if the address being accessed by the exclusive code sequence is in cacheable memory, any eviction of the cache line containing that address clears the monitor. ARM therefore recommends that no load or store instructions are placed between the exclusive load and the exclusive store because these additional instructions can cause a cache eviction. Any data cache maintenance instruction can also clear the exclusive monitor.

6.5.2 ACE transactions

Table 6-2 shows the ACE transactions that each type of memory access generates.

Table 6-2 ACE transactions

Attributes		ACE transaction				
Memory type	Shareability	Domain	Load	Store	Load exclusive	Store exclusive
Device	-	System	ReadNoSnoop	WriteNoSnoop	ReadNoSnoop and ARLOCKM set to HIGH	WriteNoSnoop and AWLOCKM set to HIGH
Normal, inner Non-cacheable, outer Non-cacheable	Non-shared	System	ReadNoSnoop	WriteNoSnoop	ReadNoSnoop and ARLOCKM set to HIGH	WriteNoSnoop and AWLOCKM set to HIGH
	Inner-shared					
	Outer-shared					
Normal, inner Non-cacheable, outer Write-Back or Write-Through, or Normal, inner Write-Through, outer Write-Back, Write-Through or Non-cacheable, or Normal inner Write-Back outer Non-cacheable or Write-Through	Non-shared	System	ReadNoSnoop	WriteNoSnoop	ReadNoSnoop	ReadNoSnoop
	Inner-shared	System	ReadNoSnoop	WriteNoSnoop	ReadNoSnoop with ARLOCKM set to HIGH	WriteNoSnoop with ARLOCKM set to HIGH
	Outer-shared	System				
Normal, inner Write-Back, outer Write-Back	Non-shared	Non-shareable	ReadNoSnoop	WriteNoSnoop	ReadNoSnoop	WriteNoSnoop
	Inner-shared	Inner Shareable	ReadShared	ReadUnique or CleanUnique if required, then a WriteBack when the line is evicted	ReadShared with ARLOCKM set to HIGH	CleanUnique with ARLOCKM set to HIGH if required, then a WriteBack when the line is evicted
	Outer-shared	Outer Shareable				

See the *ARM® AMBA® AXI and ACE Protocol Specification AXI3, AXI4, and AXI4-Lite, ACE and ACE-Lite* for more information about ACE transactions.

6.5.3 CHI transactions

Table 6-3 shows the CHI transactions that each type of memory access generates.

Table 6-3 CHI transactions

Attributes		CHI transaction				
Memory type	Shareability	SnpAttr	Load	Store	Load exclusive	Store exclusive
Device	-	Non-snoopable	ReadNoSnp	WriteNoSnp	ReadNoSnp and Excl set to HIGH	WriteNoSnp and Excl set to HIGH
Normal, inner Non-cacheable, outer Non-cacheable	Non-shared	Non-snoopable	ReadNoSnp	WriteNoSnp	ReadNoSnp and Excl set to HIGH	WriteNoSnp and Excl set to HIGH
	Inner-shared					
	Outer-shared					
Normal, inner Non-cacheable, outer Write-Back or Write-Through, or Normal, inner Write-Through, outer Write-Back, Write-Through or Non-cacheable, or Normal inner Write-Back outer Non-cacheable or Write-Through	Non-shared	Non-snoopable	ReadNoSnp	WriteNoSnp	ReadNoSnp	ReadNoSnp
	Inner-shared	Non-snoopable	ReadNoSnp	WriteNoSnp	ReadNoSnp with Excl set to HIGH	WriteNoSnp with Excl set to HIGH
	Outer-shared	Non-snoopable				
Normal, inner Write-Back, outer Write-Back	Non-shared	Non-snoopable	ReadNoSnp	WriteNoSnp	ReadNoSnp	WriteNoSnp
	Inner-shared	Inner snoopable	ReadShared	ReadUnique, CleanUnique, or MakeUnique if allocating into the cache, then a WriteBackFull when the line is evicted.	ReadShared with Excl set to HIGH	CleanUnique with Excl set to HIGH if required, then a WriteBackFull when the line is evicted
	Outer-shared	Outer snoopable		WriteUniqueFull or WriteUniquePtl if not allocating into the cache.		

See the *ARM® AMBA® 5 CHI Protocol Specification* for more information about CHI transactions.

6.6 Data prefetching

This section describes:

- [Preload instructions](#).
- [Data prefetching and monitoring](#).
- [Non-temporal loads](#).
- [Data Cache Zero](#).

6.6.1 Preload instructions

The Cortex-A53 processor supports the PLD and PRFM prefetch hint instructions. PLD and PRFM instructions lookup in the cache, and start a linefill if they miss and are to a cacheable address. However, the PLD or PRFM instruction retires as soon as its linefill is started rather than waiting for data to be returned. This enables other instructions to execute while the linefill continues in the background. If the memory type is Shareable, then any linefill started by a PLDW instruction also causes the data to be invalidated in other cores, so that the line is ready for writing.

PST, or PLDW in AArch32, is similar to a PLD, except that if it misses, it requests an exclusive linefill instead of a shared one. The PRFMs also enable targeting of a prefetch to the L2 cache. When this is the case, a request is sent to L2 to start a linefill, and then the instruction can retire, without any data being returned to L1. PLI is implemented as a NOP.

6.6.2 Data prefetching and monitoring

The data cache implements an automatic prefetcher that monitors cache misses in the core. When a pattern is detected, the automatic prefetcher starts linefills in the background. The prefetcher recognizes a sequence of data cache misses at a fixed stride pattern that lies in four cache lines, plus or minus. Any intervening stores or loads that hit in the data cache do not interfere with the recognition of the cache miss pattern.

The CPUACTLR, see the [CPU Auxiliary Control Register, EL1 on page 4-124](#), enables you to:

- Deactivate the prefetcher.
- Alter the sequence length required to trigger the prefetcher.
- Alter the number of outstanding requests that the prefetcher can make.

Use the PLD or PRFM instruction for data prefetching where short sequences or irregular pattern fetches are required.

6.6.3 Non-temporal loads

Cache requests made by a non-temporal load instruction (LDNP) are allocated to the L2 cache only. The allocation policy makes it likely that the line is replaced sooner than other lines.

6.6.4 Data Cache Zero

The ARMv8-A architecture introduces a Data Cache Zero by Virtual Address (DC ZVA) instruction. This enables a block of 64 bytes in memory, aligned to 64 bytes in size, to be set to zero. If the DC ZVA instruction misses in the cache, it clears main memory, without causing an L1 or L2 cache allocation.

6.7 Direct access to internal memory

The Cortex-A53 processor provides a mechanism to read the internal memory used by the Cache and TLB structures through IMPLEMENTATION-DEFINED system registers. This functionality can be useful when investigating issues where the coherency between the data in the cache and data in system memory is broken.

When the processor is using AArch64, the appropriate memory block and location are selected using a number of write-only registers and the data is read from read-only registers as shown in [Table 6-5](#). These operations are available only in EL3. In all other modes, executing these instruction results in an Undefined Instruction exception.

Table 6-4 AArch64 registers used to access internal memory

Function	Access	Operation	Rd Data
Data Register 0	Read-only	MRS <Xd>, S3_3_c15_c0_0	Data
Data Register 1	Read-only	MRS <Xd>, S3_3_c15_c0_1	Data
Data Register 2	Read-only	MRS <Xd>, S3_3_c15_c0_2	Data
Data Register 3	Read-only	MRS <Xd>, S3_3_c15_c0_3	Data
Data Cache Tag Read Operation Register	Write-only	MSR S3_3_c15_c2_0, <Xd>	Set/Way
Instruction Cache Tag Read Operation Register	Write-only	MSR S3_3_c15_c2_1, <Xd>	Set/Way
Data Cache Data Read Operation Register	Write-only	MSR S3_3_c15_c4_0, <Xd>	Set/Way/Offset
Instruction Cache Data Read Operation Register	Write-only	MSR S3_3_c15_c4_1, <Xd>	Set/Way/Offset
TLB Data Read Operation Register	Write-only	MSR S3_3_c15_c4_2, <Xd>	Index/Way

When the processor is using AArch32, the appropriate memory block and location are selected using a number of write-only CP15 registers and the data is read from read-only CP15 registers as shown in [Table 6-5](#). These operations are available only in EL3. In all other modes, executing the CP15 instruction results in an Undefined Instruction exception.

Table 6-5 AArch32 CP15 registers used to access internal memory

Function	Access	CP15 operation	Rd Data
Data Register 0	Read-only	MRC p15, 3, <Rd>, c15, c0, 0	Data
Data Register 1	Read-only	MRC p15, 3, <Rd>, c15, c0, 1	Data
Data Register 2	Read-only	MRC p15, 3, <Rd>, c15, c0, 2	Data
Data Register 3	Read-only	MRC p15, 3, <Rd>, c15, c0, 3	Data
Data Cache Tag Read Operation Register	Write-only	MCR p15, 3, <Rd>, c15, c2, 0	Set/Way
Instruction Cache Tag Read Operation Register	Write-only	MCR p15, 3, <Rd>, c15, c2, 1	Set/Way
Data Cache Data Read Operation Register	Write-only	MCR p15, 3, <Rd>, c15, c4, 0	Set/Way/Offset
Instruction Cache Data Read Operation Register	Write-only	MCR p15, 3, <Rd>, c15, c4, 1	Set/Way/Offset
TLB Data Read Operation Register	Write-only	MCR p15, 3, <Rd>, c15, c4, 2	Index/Way

The following sections describe the encodings for the operations and the format for the data read from the memory:

- [Data cache tag and data encoding](#).
- [Instruction cache tag and data encoding on page 6-15](#).
- [TLB RAM accesses on page 6-16](#).

6.7.1 Data cache tag and data encoding

The Cortex-A53 processor data cache consists of a 4-way set-associative structure. The number of sets in each way depends on the configured size of the cache. The encoding, set in Rd in the appropriate MCR instruction, used to locate the required cache data entry for tag and data memory is shown in [Table 6-6](#). It is very similar for both the tag and data RAM access. Data RAM access includes an additional field to locate the appropriate doubleword in the cache line. The set-index range parameter (S) is determined by:

$$S = \log_2(\text{Data cache size} / 4).$$

Table 6-6 Data cache tag and data location encoding

Bit-field of Rd	Description
[31:30]	Cache way
[29:S+5]	Unused
[S+4:6]	Set index
[5:3]	Cache doubleword data offset, Data Register only
[2:0]	Unused, RAZ

Data cache reads return 64 bits of data in Data Register 0 and Data Register 1. The tag information, MOESI coherency state, outer attributes, and valid, for the selected cache line is returned using Data Register 0 and Data Register 1 using the format shown in [Table 6-7](#). The Cortex-A53 processor encodes the 4-bit MOESI coherency state across two fields of Data Register 0 and Data Register 1.

Table 6-7 Data cache tag data format

Register	Bit-field	Description
Data Register 1	[31]	Parity bit if ECC is implemented, otherwise RES0.
Data Register 1	[30:29]	Partial MOESI State, from tag RAM. See Table 6-8 on page 6-15 .
Data Register 1	[28]	Non-secure state (NS).
Data Register 1	[27:0]	Tag Address [39:12].
Data Register 0	[31]	Tag Address [11].
Data Register 0	[30:6]	Reserved, RES0.
Data Register 0	[5]	Parity bit if ECC is implemented, otherwise RES0.
Data Register 0	[4]	Dirty copy bit if ECC is implemented, otherwise RES0.

Table 6-7 Data cache tag data format (continued)

Register	Bit-field	Description
Data Register 0	[3]	Outer Allocation Hint.
Data Register 0	[2]	Outer Shareability, from Dirty RAM.
Data Register 0	[1:0]	Partial MOESI state, from Dirty RAM. See Table 6-8.

The CP15 Data Cache Data Read Operation returns two entries from the cache in Data Register 0 and Data Register 1 corresponding to the 16-bit aligned offset in the cache line:

Data Register 0 Bits[31:0] data from cache offset+ 0b000.

Data Register 1 Bits[31:0] data from cache offset+ 0b100.

The 64 bits of cache data is returned in Data register 0 and Data register 1.

Table Table 6-8 describes the MOESI state.

Table 6-8 MOESI state

Tag RAM partial MOESI bits	Dirty RAM partial MOESI bits	MOESI state
00	xx	Invalid (I)
01	x0	SharedClean (S)
	x1	SharedDirty (O)
1x	x0	UniqueClean (E)
	x1	UniqueDirty (M)

6.7.2 Instruction cache tag and data encoding

The Cortex-A53 processor instruction cache is significantly different from the data cache and this is shown in the encodings and data format used in the CP15 operations used to access the tag and data memories. Table 6-9 shows the encoding required to select a given cache line. The set-index range parameter (S) is determined by:

$S = \log_2(\text{Instruction cache size (Byte)} / 2 * 32)$ for the 2-way set-associative cache.

Table 6-9 Instruction cache tag and data location encoding

Bit-field of Rd	Description
[31]	Cache Way
[30:S+5]	Unused
[S+4:6]	Set index
[5:2]	Line offset
[1:0]	Unused

Table 6-10 shows the tag and valid bits format for the selected cache line using only Data Register 0.

Table 6-10 Instruction cache tag data format

Bits	Description
[31]	Parity ^a .
[30:29]	Valid and set mode: 0b00 A32. 0b01 T32. 0b10 A64. 0b11 Invalid.
[28]	Non-secure state (NS).
[27:0]	Tag address.

a. Parity bit is not available for a CP15 Instruction cache Tag Read Operation. In this case, this bit is 1'b0.

The CP15 Instruction Cache Data Read Operation returns two entries from the cache in Data Register 0 and Data Register 1 corresponding to the 16-bit aligned offset in the cache line:

Data Register 0 Bits[19:0] data from cache offset+ 0b00.

Data Register 1 Bits[19:0] data from cache offset+ 0b10.

In A32 or A64 state these two fields combined always represent a single pre-decoded instruction. In T32 state, they can represent any combination of 16-bit and partial or full 32-bit instructions.

6.7.3 TLB RAM accesses

The Cortex-A53 processor unified TLB is built from a 4-way set-associative RAM based structure. To read the individual entries into the data registers software must write to the TLB Data Read Operation Register. Table 6-11 shows the write TLB Data Read Operation Register location encoding of Rd.

Table 6-11 TLB Data Read Operation Register location encoding

Bits	Description
[31:30]	TLB way
[29:8]	Unused
[7:0]	TLB index

The TLB RAM contains the data for the main TLB, the walk cache, and the *Intermediate Physical Address* (IPA) cache RAMs. [Table 6-12](#) shows the TLB indexes that determines the format of the TLB RAM accesses.

Table 6-12 TLB RAM format

TLB index[7:0]	Format
0-127	Main TLB RAM, see Main TLB RAM
128-143	Walk cache RAM, see Walk cache RAM on page 6-20
144-159	IPA cache RAM, see IPA cache RAM on page 6-21
160-255	Unused

Main TLB RAM

The main TLB RAM uses a 117-bit encoding:

Data Register 0[31:0] TLB Descriptor[31:0].

Data Register 1[31:0] TLB Descriptor[63:32].

Data Register 2[31:0] TLB Descriptor[95:64].

Data Register 3[20:0] TLB Descriptor[116:96].

[Table 6-13](#) shows the data fields in the TLB descriptor.

Table 6-13 Main TLB descriptor data fields

Bits	Name	Description
[116:114]	Parity	ECC inclusion is processor configuration dependent. If ECC is not configured, these bits are absent.
[113:112]	S2 Level	The stage 2 level that gave this translation: 0b00 No stage 2 translation performed. 0b01 Level 1. 0b10 Level 2. 0b11 Level 3.
[111:109]	S1 Size	The stage 1 size that gave this translation: 0b000 4KB. 0b001 64KB. 0b010 1MB. 0b011 2MB. 0b100 16MB. 0b101 512MB. 0b110 1GB.
[108:105]	Domain	Valid only if the entry was fetched in VMSAv7 format.
[104:97]	Memory Type and shareability	See Table 6-14 on page 6-18 .
[96]	XS2	Stage2 executable permissions.
[95]	XS1Nonusr	Non user mode executable permissions.
[94]	XS1Usr	User mode executable permissions.
[93:66]	PA	Physical Address.

Table 6-13 Main TLB descriptor data fields (continued)

Bits	Name	Description
[65]	NS, descriptor	Security state allocated to memory region.
[64:63]	HAP	Hypervisor access permissions.
[62:60]	AP or HYP	Access permissions from stage-1 translation, or select EL2 or flag.
[59]	nG	Not global.
[58:56]	Size	This field shows the encoding for the page size: VMSAv8-32 Short-descriptor translation table format: 0b000 4KB. 0b010 64KB. 0b100 1MB. 0b110 16MB. VMSAv8-32 Long-descriptor translation table format or VMSAv8-64 translation table format: 0b001 4KB. 0b011 64KB. 0b101 2MB. 0b111 512MB.
[55:40]	ASID	Address Space Identifier.
[39:32]	VMID	Virtual Machine Identifier.
[31]	NS (walk)	Security state that the entry was fetched in.
[30:2]	VA	Virtual Address.
[1]	Address Sign bit	VA[48] sign bit.
[0]	Valid	Valid bit: 0 Entry does not contain valid data. 1 Entry contains valid data.

Table 6-14 shows the main TLB memory types and shareability.

Table 6-14 Main TLB memory types and shareability

Bits	Memory type	Description
[7]	Device	0
	Non-coherent, Outer WB	
	Non-coherent, Outer NC	
	Non-coherent, Outer WT	
	Coherent, Inner WB and Outer WB	1

Table 6-14 Main TLB memory types and shareability (continued)

Bits	Memory type	Description	
[6]	Device	0	
	Non-coherent, Outer WB		
	Non-coherent, Outer NC	1	
	Non-coherent, Outer WT		
	Coherent, Inner WB and Outer WB	Transient: 0 Non-transient 1 Transient.	
[5:4]	Device	Stage 1 (Non-device) overridden by stage 2 (Device) 00 Not overridden 01 Overridden.	
	Non-coherent, Outer WB	Inner type: 10 NC. 11 WT.	
	Non-coherent, Outer NC	11	
	Non-coherent, Outer WT	Inner type: 00 NC. 01 WB. 10 WT.	
	Coherent, Inner WB and Outer WB	Inner allocation hint: 00 NA. 01 WA. 10 RA. 11 WRA.	
	[3:2]	Device	Device type: 00 nGnRnE. 01 nGnRE. 10 nGRE. 11 GRE.
		Non-coherent, Outer WB	Outer allocation hint: 00 NA.
		Non-coherent, Outer WT	01 WA.
		Coherent, Inner WB and Outer WB	10 RA. 11 WRA.
		Non-coherent, Outer NC	Inner type: 00 NC. 01 WB. 10 WT. 11 Unused.

Table 6-14 Main TLB memory types and shareability (continued)

Bits	Memory type	Description
[1:0]	Device	Shareability
	Non-coherent, Outer WB	00 Non-shareable.
		01 Unused.
	Non-coherent, Outer NC	10 Outer shareable.
	Non-coherent, Outer WT	11 Inner shareable.
	Coherent, Inner WB and Outer WB	

Walk cache RAM

The walk cache RAM uses 117-bit encoding when parity is enabled and 114-bit encoding when parity is disabled. Table 6-15 shows the data fields in the walk cache descriptor.

Table 6-15 Walk cache descriptor fields

Bits	Name	Description
[116:114]	ECC	ECC. If ECC is not configured, these bits are absent.
[113:84]	PA	Physical Address of second, last translation level.
[83:60]	VA	Virtual address.
[59:56]	-	Reserved, must be zero.
[55:40]	ASID	Address Space Identifier.
[39:22]	VMID	Virtual Machine Identifier.
[31]	NS, walk	Security state that the entry was fetched in.
[30:22]	-	Reserved, must be zero.
[21:18]	Domain	Valid only if the entry was fetched in VMsAv7 format.
[17:16]	Entry size	Memory size to which entry maps: 0b00 1MB. 0b01 2MB. 0b10 512MB. 0b11 Unused.
[15]	NSTable	Combined NSTable bits from first and second level stage 1 tables or NS descriptor (VMSA).
[14]	PXNTable	Combined PXNTable bits from stage1 descriptors up to last level.
[13]	XNTable	Combined XNTable bit from stage1 descriptors up to last level.
[12:11]	APTable	Combined APTable bits from stage1 descriptors up to last level.
[10]	EL3	Set if the entry was fetched in AArch64 EL3 mode.
[9]	EL2	Set if the entry was fetched in EL2 mode.
[8:1]	Attrs	Physical attributes of the final level stage 1 table.
[0]	Valid	Valid bit: 0 Entry does not contain valid data. 1 Entry contains valid data.

IPA cache RAM

The *Intermediate Physical Address* (IPA) cache RAM uses a 117-bit encoding when parity is enabled and 114-bit encoding when parity is disabled. Table 6-16 shows the data fields in the IPA cache descriptor.

Table 6-16 IPA cache descriptor fields

Bits	Name	Description
[116:114]	ECC	ECC. If ECC is not configured, these bits are absent.
[113:86]	PA	Physical address.
[85:62]	IPA	Unused lower bits, page size dependent, must be zero.
[61:59]	-	Reserved, must be zero.
[58:56]	Size	The size values are: 0b011 64KB. 0b101 2MB. 0b111 512MB.
[55:40]	-	Reserved, must be zero.
[39:32]	VMID	Virtual Machine Identifier.
[31:11]	-	Reserved, must be zero.
[10]	Contiguous	Set if the pagewalk had contiguous bit set.
[9:6]	Memattrs	Memory attributes.
[5]	XN	Execute Never.
[4:3]	HAP	Hypervisor access permissions.
[2:1]	SH	Shareability.
[0]	Valid	The entry contains valid data.

Chapter 7

Level 2 Memory System

This chapter describes the L2 memory system. It contains the following sections:

- *About the L2 memory system* on page 7-2.
- *Snoop Control Unit* on page 7-3.
- *ACE master interface* on page 7-6.
- *CHI master interface* on page 7-13.
- *Additional memory attributes* on page 7-17.
- *Optional integrated L2 cache* on page 7-18.
- *ACP* on page 7-19.

7.1 About the L2 memory system

The L2 memory system consists of an:

- Integrated *Snoop Control Unit* (SCU), connecting up to four cores within a cluster. The SCU also has duplicate copies of the L1 Data cache tags for coherency support. The L2 memory system interfaces to the external memory system with either an AMBA 4 ACE bus or an AMBA 5 CHI bus. All bus interfaces are 128-bits wide.
- Optional tightly-coupled L2 cache that includes:
 - Configurable L2 cache size of 128KB, 256KB, 512KB, 1MB and 2MB.
 - Fixed line length of 64 bytes.
 - Physically indexed and tagged cache.
 - 16-way set-associative cache structure.
 - Optional ACP interface if an L2 cache is configured.
 - Optional ECC protection.

The L2 memory system has a synchronous abort mechanism and an asynchronous abort mechanism, see [External aborts handling on page 7-18](#).

7.2 Snoop Control Unit

The Cortex-A53 processor supports between one and four individual cores with L1 Data cache coherency maintained by the SCU. The SCU is clocked synchronously and at the same frequency as the cores.

The SCU maintains coherency between the individual data caches in the processor using ACE modified equivalents of MOESI state, as described in [Data Cache Unit on page 2-4](#).

The SCU contains buffers that can handle direct cache-to-cache transfers between cores without having to read or write any data to the external memory system. Cache line migration enables dirty cache lines to be moved between cores, and there is no requirement to write back transferred cache line data to the external memory system.

Each core has tag and dirty RAMs that contain the state of the cache line. Rather than access these for each snoop request the SCU contains a set of duplicate tags that permit each coherent data request to be checked against the contents of the other caches in the cluster. The duplicate tags filter coherent requests from the system so that the cores and system can function efficiently even with a high volume of snoops from the system.

When an external snoop hits in the duplicate tags a request is made to the appropriate core.

7.2.1 Bus interface configuration signals

The Cortex-A53 processor implements the following bus interface configuration signals:

- **BROADCASTINNER.**
- **BROADCASTOUTER.**
- **BROADCASTCACHEMAINT.**
- **SYSBARDISABLE** (ACE only).

[Table 7-1](#) shows the permitted combinations of these signals and the supported configurations in the Cortex-A53 processor, with an ACE bus.

Table 7-1 Supported ACE configurations

Signal	Feature						
	AXI3 mode ^a	ACE non-coherent ^b		ACE outer coherent		ACE inner coherent	
		No L3 cache	With L3 cache	No L3 cache	With L3 cache	No L3 cache	With L3 cache
BROADCASTCACHEMAINT	0	0	1	0	1	0	1
BROADCASTOUTER	0	0	0	1	1	1	1
BROADCASTINNER	0	0	0	0	0	1	1

a. **SYSBARDISABLE** must be set to HIGH in AXI3 mode.

b. ACE non-coherent is compatible with connecting to an ACE-Lite interconnect.

Table 7-2 shows the key features in each of the supported ACE configurations.

Table 7-2 Supported features in the ACE configurations

Features	Configuration				
	AXI3 mode	ACE non-coherent, no L3 cache	ACE non-coherent, with L3 cache	ACE outer coherent	ACE inner coherent
AXI3 compliance	Yes	No	No	No	No
ACE compliance	No	Yes	Yes	Yes	Yes
Barriers on AR and AW channels	No	Yes ^a	Yes ^a	Yes ^a	Yes ^a
Cache maintenance requests on AR channel	No	No	Yes	Yes	Yes
Snoops on AC channel	No	No	No	Yes	Yes
Coherent requests on AR or AW channel	No	No	No	Yes	Yes
DVM requests on AR channel	No	No	No	No	Yes

a. Only true if **SYSBARDISABLE** is LOW. If **SYSBARDISABLE** is HIGH then barriers are not broadcast.

Table 7-3 shows the permitted combinations of these signals and the supported configurations in the Cortex-A53 processor, with a CHI bus.

Table 7-3 Supported CHI configurations

Signal	Feature					
	CHI non-coherent		CHI outer coherent		CHI inner coherent	
	No L3 cache	With L3 cache	No L3 cache	With L3 cache	No L3 cache	With L3 cache
BROADCASTCACHEMAINT	0	1	0	1	0	1
BROADCASTOUTER	0	0	1	1	1	1
BROADCASTINNER	0	0	0	0	1	1

Table 7-4 shows the key features in each of the supported CHI configurations.

Table 7-4 Supported features in the CHI configurations

Features	Configuration			
	CHI non-coherent, no L3 cache	CHI non-coherent, with L3 cache	CHI outer coherent	CHI inner coherent
Cache maintenance requests on TXREQ channel	No	Yes	Yes	Yes
Snoops on RXREQ channel	No	No	Yes	Yes
Coherent requests on TXREQ channel	No	No	Yes	Yes
DVM requests on TXREQ channel	No	No	No	Yes

7.2.2 Snoop and maintenance requests

The SCU controls snoop and maintenance requests to the system using the external **BROADCASTINNER**, **BROADCASTOUTER**, and **BROADCASTCACHEMAINT** pins:

- When you set the **BROADCASTINNER** pin to 1 the inner shareability domain extends beyond the Cortex-A53 processor and Inner Shareable snoop and maintenance operations are broadcast externally. When you set the **BROADCASTINNER** pin to 0 the inner shareability domain does not extend beyond the Cortex-A53 processor.
- When you set the **BROADCASTOUTER** pin to 1 the outer shareability domain extends beyond the Cortex-A53 processor and outer shareable snoop and maintenance operations are broadcast externally. When you set the **BROADCASTOUTER** pin to 0 the outer shareability domain does not extend beyond the Cortex-A53 processor.
- When you set the **BROADCASTCACHEMAINT** pin to 1 this indicates to the Cortex-A53 processor that there are external downstream caches and maintenance operations are broadcast externally. When you set the **BROADCASTCACHEMAINT** pin to 0 there are no downstream caches external to the Cortex-A53 processor.

Note

- If you set the **BROADCASTINNER** pin to 1 you must also set the **BROADCASTOUTER** pin to 1.
 - In a system that contains Cortex-A53 processors and other processors in a big.LITTLE configuration, you must ensure the **BROADCASTINNER** and **BROADCASTOUTER** pins on both processors are set to HIGH so that both processors are in the same Inner Shareable domain.
 - Cacheable loads and stores to a shareability domain, that does not extend beyond the Cortex-A53 processor, can allocate data to the L1 and L2 caches. However they do not make coherent requests on the master for these accesses. Instead, they use only ReadNoSnoop or WriteNoSnoop transactions. This always includes non-shareable memory, and might include inner shareable and outer shareable memory, depending on the setting of the **BROADCASTINNER** and **BROADCASTOUTER** pins.
 - If the system sends a snoop to the Cortex-A53 processor for an address that is present in the L1 or L2 cache, but the line in the cache is in a shareability domain that does not extend beyond the cluster, then the snoop is treated as missing in the cluster.
-

7.3 ACE master interface

This section describes the properties of the ACE master interface. The ACE interface to the system can be clocked at integer ratios of the **CLKIN** frequency.

7.3.1 Memory interface attributes

Table 7-5 shows the ACE master interface attributes for the Cortex-A53 processor. The table lists the maximum possible values for the read and write issuing capabilities if the processor includes four cores.

Table 7-5 ACE master interface attributes

Attribute	Value ^a	Comments
Write issuing capability	$17 + n$	<p>The cluster can issue a maximum of 16 writes, excluding barriers:</p> <ul style="list-style-type: none"> Up to 16 writes to Normal memory that is both inner and outer write-back cacheable. Up to 15 writes to all other memory types, including Device, Normal non-cacheable and Write-through. <p>Any mix of memory types is possible, and each write can be a single write or a write burst. Each core can also issue a barrier and the cluster can issue an additional barrier.</p>
Read issuing capability	$8n + 4m + 1$	<p>8 for each core in the cluster including up to:</p> <ul style="list-style-type: none"> 8 data linefills. 4 non-cacheable or Device data reads. 1 non-cacheable TLB page-walk read. 3 instruction linefills. 5 coherency operations. 1 barrier operation. 8 DVM messages. <p style="text-align: center;">———— Note —————</p> <p>The 8 DVM messages per core can each be two part DVM messages, resulting in up to 16 DVM transactions per core.</p> <p>If an ACP is configured, up to 4 ACP linefill requests can be generated. 1 barrier operation can be generated from the cluster.</p>
Exclusive thread capability	n	Each core can have 1 exclusive access sequence in progress.
Write ID capability	$17 + n$	<p>The maximum number of outstanding write IDs is 21. This is the same as the maximum number of outstanding writes.</p> <p>Only Device memory types with nGnRnE or nGnRE can have more than one outstanding transaction with the same AXI ID. All other memory types use a unique AXI ID for every outstanding transaction.</p>

Table 7-5 ACE master interface attributes (continued)

Attribute	Value ^a	Comments
Write ID width	5	The ID encodes the source of the memory transaction. See Table 7-6 .
Read ID capability	$8n + 4m + 1$	<p>8 for each core in the cluster in addition to:</p> <ul style="list-style-type: none"> 4 for the ACP. 1 for barriers. <p>Only Device memory types with nGnRnE or nGnRE can have more than one outstanding transaction with the same AXI ID. All other memory types use a unique AXI ID for every outstanding transaction.</p> <p>Two part DVMs use the same ID for both parts, and therefore can have two outstanding transactions on the same ID.</p>
Read ID width	6	The ID encodes the source of the memory transaction. See Table 7-7 on page 7-8 .

a. n is the number of cores.

m is 1 if the processor is configured with an ACP interface, and 0 otherwise.

[Table 7-6](#) shows the encodings for **AWIDM[4:0]**

Table 7-6 Encodings for AWIDM[4:0]

Attribute	Value	Issuing capability per ID	Comments
Write ID	0b000nn ^a	1	Core nn system domain store exclusive
	0b001nn ^a	1	Core nn barrier
	0b01000	0	Unused
	0b01001	1	SCU generated barrier
	0b0101x	0	Unused
	0b011nn ^a	15	Core nn non-re-orderable device write
	0b1xxxx	1	Write to normal memory, or re-orderable device memory

a. Where nn is the core number 0b00, 0b01, 0b10, or 0b11.

Table 7-7 shows the Encodings for ARIDM[5:0]

Table 7-7 Encodings for ARIDM[5:0]

Attribute	Value	Issuing capability per ID	Comments
Read ID	0b0000nn ^a	4	Core nn exclusive read or non-reorderable device read
	0b0001nn ^a	1	Core nn barrier
	0b001000	0	Unused
	0b001001	1	SCU generated barrier or DVM complete
	0b00101x	0	Unused
	0b0011xx	0	Unused
	0b01xx00	1	ACP read
	0b01xx01	0	Unused
	0b01xx1x	0	Unused
	0b1xxxnn ^a	1	Core nn read

a. Where nn is the core number 0b00, 0b01, 0b10, or 0b11.

Note

These ID and transaction details are provided for information only. ARM strongly recommends that all interconnects and peripherals are designed to support any type and number of transactions on any ID, to ensure compatibility with future products.

See the *ARM® AMBA® AXI and ACE Protocol Specification AXI3, AXI4, and AXI4-Lite, ACE and ACE-Lite* for more information about the ACE and AXI signals described in this manual.

7.3.2 ACE transfers

The Cortex-A53 processor does not generate any FIXED bursts and all WRAP bursts fetch a complete cache line starting with the critical word first. A burst does not cross a cache line boundary.

The cache linefill fetch length is always 64 bytes.

The Cortex-A53 processor generates only a subset of all possible AXI transactions on the master interface.

For WriteBack transfers the supported transfers are:

- WRAP 4 128-bit for read transfers (linefills).
- INCR 4 128-bit for write transfers (evictions).
- INCR N (N:1, 2, or 4) 128-bit write transfers (read allocate).

For Non-cacheable transactions:

- INCR N (N:1, 2, or 4) 128-bit for write transfers.
- INCR N (N:1, 2, or 4) 128-bit for read transfers.
- INCR 1 8-bit, 16-bit, 32-bit, 64-bit, and 128-bit for read transfers.
- INCR 1 8-bit, 16-bit, 32-bit, 64-bit, and 128-bit for write transfers.
- INCR 1 8-bit, 16-bit, 32-bit, 64-bit, and 128-bit for exclusive write transfers.

- INCR 1 8-bit, 16-bit, 32-bit, 64-bit, and 128-bit for exclusive read transfers.

For Device transactions:

- INCR N (N:1, 2, or 4) 128-bit read transfers.
- INCR N (N:1, 2, or 4) 128-bit write transfers.
- INCR 1 8-bit, 16-bit, 32-bit, 64-bit, and 128-bit read transfers.
- INCR 1 8-bit, 16-bit, 32-bit, 64-bit, and 128-bit write transfers.
- INCR 1 8-bit, 16-bit, 32-bit, 64-bit, and 128-bit exclusive read transfers.
- INCR 1 8-bit, 16-bit, 32-bit, 64-bit, and 128-bit exclusive write transfers.

For translation table walk transactions INCR 1 32-bit, and 64-bit read transfers.

The following points apply to AXI transactions:

- WRAP bursts are only 128-bit.
- INCR 1 can be any size for read or write.
- INCR burst, more than one transfer, are only 128-bit.
- No transaction is marked as FIXED.
- Write transfers with none, some, or all byte strobes LOW can occur.

Table 7-8 shows the ACE transactions that can be generated, and some typical operations that might cause the transactions to be generated. This is not an exhaustive list of ways to generate each type of transaction, because there are many possibilities.

Table 7-8 ACE transactions

Transaction	Operation
ReadNoSnoop	Non-cacheable loads or instruction fetches. Linefills of non-shareable cache lines into L1 or L2.
ReadOnce	Cacheable loads that are not allocating into the cache, or cacheable instruction fetches when there is no L2 cache.
ReadClean	Not used.
ReadNotSharedDirty	Not used.
ReadShared	L1 Data linefills started by a load instruction, or L2 linefills started by an instruction fetch.
ReadUnique	L1 Data linefills started by a store instruction.
CleanUnique	Store instructions that hit in the cache but the line is not in a unique coherence state. Store instructions that are not allocating into the L1 or L2 caches, for example when streaming writes.
MakeUnique	Store instructions of a full cache line of data, that miss in the caches, and are allocating into the L2 cache.
CleanShared	Cache maintenance instructions.
CleanInvalid	Cache maintenance instructions.
MakeInvalid	Cache maintenance instructions.
DVM	TLB and instruction cache maintenance instructions.
DVM complete	DVM sync snoops received from the interconnect.
Barriers	DMB and DSB instructions. DVM sync snoops received from the interconnect.
WriteNoSnoop	Non-cacheable store instructions. Evictions of non-shareable cache lines from L1 and L2.
WriteUnique	Not used.
WriteLineUnique	Not used.

Table 7-8 ACE transactions (continued)

Transaction	Operation
WriteBack	Evictions of dirty lines from the L1 or L2 cache, or streaming writes that are not allocating into the cache.
WriteClean	Evictions of dirty lines from the L2 cache, when the line is still present in an L1 cache. Some cache maintenance instructions.
WriteEvict	Evictions of unique clean lines, when configured in the L2ACTLR.
Evict	Evictions of clean lines, when configured in the L2ACTLR.

7.3.3 Snoop channel properties

Table 7-9 shows the properties of the ACE channels.

Table 7-9 ACE channel properties

Property	Value	Comment
Snoop acceptance capability	8	The SCU can accept and process a maximum of eight snoop requests from the system. It counts requests from the request being accepted on the AC channel to the response being accepted on the CR channel.
Snoop latency	Hit	When there is a hit in L2 cache, the best case for response and data is 13 processor cycles. When there is a miss in L2 cache and a hit in L1 cache, the best case for response and data is 16 processor cycles. ———— Note ————— Latencies can be higher if hazards occur or if there are not enough buffers to absorb requests.
	Miss	Best case six processor cycles when the SCU duplicate tags and L2 tags indicate the miss.
	DVM	The cluster takes a minimum of six cycles to provide a response to DVM packets.
Snoop filter	Supported	The cluster provides support for an external snoop filter in an interconnect. It indicates when clean lines are evicted from the processor by sending Evict transactions on the write channel. However there are some cases where incorrect software can prevent an Evict transaction from being sent. Therefore you must ensure that you build any external snoop filter to handle a capacity overflow that sends a back-invalidation to the processor if it runs out of storage. Examples of cases where evicts are not produced include: <ul style="list-style-type: none"> • Linefills that take external aborts. • Store exclusives that fail. • Mis-matched aliases.
Supported transactions	-	All transactions described by the ACE protocols: <ul style="list-style-type: none"> • Are accepted on the master interface from the system. • Can be produced on the ACE master interface except: <ul style="list-style-type: none"> — WriteUnique. — WriteLineUnique. — ReadNotSharedDirty. — ReadClean.

See the *ARM® AMBA® AXI and ACE Protocol Specification AXI3, AXI4, and AXI4-Lite, ACE and ACE-Lite* for more information about the ACE channel.

7.3.4 Read response

The ACE master can delay accepting a read data channel transfer by holding **RREADY** LOW for an indeterminate number of cycles. **RREADY** can be deasserted LOW between read data channel transfers that form part of the same transaction.

The ACE master asserts the read acknowledge signal **RACK** HIGH in the **ACLK** cycle following acceptance of the last read data channel transfer for a transaction. **RACK** is asserted in AXI3 compatibility mode in addition to ACE configurations.

———— **Note** ————

- For interoperability of system components, ARM recommends that components interfacing with the ACE master are fully ACE compliant with no reliance on the subset of permitted **RACK** behavior described for the Cortex-A53 processor.
 - If the interconnect does not perform hazarding between coherent and non-coherent requests, then, after it has returned the first transfer of read data for a non-coherent read, it must return all the remaining read transfers in the transaction, without requiring progress of any snoops to the cluster that could be to the same address.
-

7.3.5 Write response

The ACE master requires that the slave does not return a write response until it has received the write address.

The ACE master always accepts write responses without delay by holding **BREADY** HIGH.

The ACE master asserts the write acknowledge signal **WACK** HIGH in the **ACLK** cycle following acceptance of a write response. **WACK** is asserted in AXI3 compatibility mode in addition to ACE configurations.

———— **Note** ————

For interoperability of system components, ARM recommends that components interfacing with the ACE master are fully ACE compliant with no reliance on the subset of permitted **BREADY** and **WACK** behavior described for the Cortex-A53 processor.

7.3.6 Barriers

The Cortex-A53 processor supports sending barrier transactions to the interconnect, or terminating barriers within the cluster.

- To send barriers on the ACE interface, set **SYSBARDISABLE** to LOW.
- To terminate barriers within the cluster, set **SYSBARDISABLE** to HIGH.

If you terminate barriers within the cluster, ensure that your interconnect and any peripherals connected to it do not return a write response for a transaction until that transaction would be considered complete by a later barrier. This means that the write must be observable to all other masters in the system. ARM expects the majority of peripherals to meet this requirement.

For best performance, ARM recommends that barriers are terminated within the cluster.

7.3.7 AXI3 compatibility mode

The Cortex-A53 processor implements an AXI3 compatibility mode that enables you to use the processor in a standalone environment where the AMBA 4 ACE interface is not required and the processor does not propagate barriers outside of the cluster. To enable this mode you must

set the **SYSBARDISABLE** input pin to HIGH on the boundary of the processor. You must also ensure that the **BROADCASTINNER**, **BROADCASTOUTER**, and **BROADCASTCACHEMAINT** input pins are set to LOW.

7.3.8 AXI privilege information

AXI provides information about the privilege level of an access on the **ARPROTM[0]** and **AWPROTM[0]** signals. However, when accesses might be cached or merged together, the resulting transaction can have both privileged and unprivileged data combined. If this happens, the Cortex-A53 processor marks the transaction as privileged, even if it was initiated by an unprivileged process.

Table 7-10 shows Cortex-A53 processor exception levels and corresponding **ARPROTM[0]** and **AWPROTM[0]** values.

Table 7-10 Cortex-A53 MPCore mode and ARPROT and AWPROT values

Processor exception level	Type of access	Value of ARPROT[0] and AWPROT[0]
EL0, EL1, EL2, EL3	Cacheable read access	Privileged access
EL0	Device, or normal Non-cacheable read access	Unprivileged access
EL1, EL2, EL3		Privileged access
EL0, EL1, EL2, EL3	Cacheable write access	Privileged access
EL0	Device, nGnRnE, nGnRE, and nGRE write	Unprivileged access
EL1, EL2, EL3		Privileged access
EL0	Normal Non-cacheable or Device GRE write, except for STREX, STREXB, STREXH, STREXD, STXR, STXRB, STXRH, STXP, STLXR, STLXRB, STLXRH and STLXP to shareable memory	Privileged access
EL0	Normal Non-cacheable write for STREX, STREXB, STREXH, STREXD, STXR, STXRB, STXRH, STXP, STLXR, STLXRB, STLXRH and STLXP to shareable memory	Unprivileged access
EL1, EL2, EL3	Normal Non-cacheable write	Privileged access
EL0, EL1, EL2, EL3	TLB page walk	Privileged access

7.4 CHI master interface

This section describes the properties of the CHI master interface. The CHI interface to the system can be clocked at integer ratios of the **CLKIN** frequency.

7.4.1 Memory interface attributes

[Table 7-11](#) shows the CHI master interface attributes for the Cortex-A53 processor. The table lists the maximum possible values for the read and write issuing capabilities if the processor includes four cores.

Table 7-11 CHI master interface attributes

Attribute	Value ^a	Comments
Write issuing capability	Configuration dependent	<p>The maximum number of writes varies, depending on the configuration of the processor:</p> <ul style="list-style-type: none"> The number of cores. The presence of the L2 cache. <p>If no L2 cache is configured:</p> <p>One core 5 outstanding writes. 2-4 cores 8 outstanding writes.</p> <p>If an L2 cache is configured:</p> <p>One core 7 outstanding writes. 2-4 cores 10 outstanding write.</p> <p>A Cortex-A53 processor configured with four cores, with L2 cache, can issue 10 outstanding transactions. A Cortex-A53 processor configured with one core, without L2 cache, can issue five outstanding transactions.</p> <p>All outstanding transactions use a unique ID.</p>
Read issuing capability	$8n + 4m + 1$	<p>8 for each core in the cluster including up to:</p> <ul style="list-style-type: none"> 8 data linefills. 4 Non-cacheable or Device data reads. 1 Non-cacheable TLB page-walk read. 3 instruction linefills. 5 coherency operations. 1 barrier operation. 8 DVM messages. <p>If an ACP is configured, up to 4 ACP linefill requests can be generated. 1 barrier operation is generated from the cluster.</p>
Exclusive thread capability	n	Each core can have 1 exclusive access sequence in progress.
Transaction ID width	8	The ID encodes the source of the memory transaction. See Table 7-6 on page 7-7 and Table 7-7 on page 7-8 .
Transaction ID capability	$8n + 4m + w + 1$	<p>8 for each core in the cluster in addition to:</p> <ul style="list-style-type: none"> 4 for the ACP interface. 1 for barriers. 6 to 11 writes, depending on the write issuing capability. <p>Unlike an AMBA 4 ACE configured Cortex-A53 processor, there is never any ID reuse, regardless of the memory type.</p>

- a. n is the number of cores.
m is the ACP interface.
w is the write issuing capability plus one.

In a CHI configured Cortex-A53 processor, there is no fixed mapping between CHI transaction IDs and cores. Some transaction IDs can be used for either reads or writes.

See the *ARM® AMBA® 5 CHI Protocol Specification* for more information about the CHI signals described in this manual.

7.4.2 CHI transfers

Table 7-12 shows the CHI transactions that can be generated, and some typical operations that might cause the transactions to be generated. This is not an exhaustive list of ways to generate each type of transaction, because there are many possibilities.

Table 7-12 CHI transactions

Transaction	Operation
ReadNoSnp	Non-cacheable loads or instruction fetches. Linefills of non-shareable cache lines into L1 or L2.
ReadOnce	Cacheable loads that are not allocating into the cache, or cacheable instruction fetches when there is no L2 cache.
ReadClean	Not used.
ReadShared	L1 Data linefills started by a load instruction, or L2 linefills started by an instruction fetch.
ReadUnique	L1 Data linefills started by a store instruction.
CleanUnique	Store instructions that hit in the cache but the line is not in a unique coherence state.
MakeUnique	Store instructions of a full cache line of data, that miss in the caches, and are allocating into the L2 cache.
CleanShared	Cache maintenance instructions.
CleanInvalid	Cache maintenance instructions.
MakeInvalid	Cache maintenance instructions.
DVMOp	TLB and instruction cache maintenance instructions.
EOBarrier	DMB instructions.
ECBarrier	DSB instructions. DVM sync snoops received from the interconnect.
WriteNoSnpPtl	Non-cacheable store instructions.
WriteNoSnpFull	Non-cacheable store instructions, or evictions of non-shareable cache lines from the L1 and L2 cache.
WriteUniqueFull	Cacheable writes of a full cache line, that are not allocating into L1 or L2 caches, for example streaming writes.
WriteLineUniquePtl	Cacheable writes of less than a full cache line that are not allocating into L1 or L2.
WriteBackFull	Evictions of dirty lines from the L1 or L2 cache.
WriteBackPtl	Not used.
WriteCleanFull	Evictions of dirty lines from the L2 cache, when the line is still present in an L1 cache. Some cache maintenance instructions.
WriteCleanPtl	Not used.
WriteEvictFull	Evictions of unique clean lines, when configured in the L2ACTLR.
Evict	Evictions of clean lines, when configured in the L2ACTLR.

7.4.3 CHI channel properties

Table 7-13 shows the properties of the CHI channels.

Table 7-13 CHI channel properties

Property	Value	Comment
Snoop acceptance capability	10	The SCU can accept and process a maximum of 10 snoop requests from the system.
DVM acceptance capability	4	The SCU can accept and process a maximum of four DVM transactions from the system. Each of these four transactions can be a two part DVM message. <p style="text-align: center;">———— Note —————</p> The interconnect must be configured to never send more than four DVM messages to a Cortex-A53 processor, otherwise the system might deadlock.
Snoop latency	Hit	When there is a hit in L2 cache, the best case for response and data is 11 processor cycles. When there is a miss in L2 cache and a hit in L1 cache, the best case for response and data is 14 processor cycles. <p style="text-align: center;">———— Note —————</p> Latencies can be higher if hazards occur or if there are not enough buffers to absorb requests.
	Miss	Best case six processor cycles when the SCU duplicate tags and L2 tags indicate the miss.
	DVM	The cluster takes a minimum of six cycles to provide a response to DVM packets.
Snoop filter	Supported	The cluster provides support for an external snoop filter in an interconnect. It indicates when clean lines are evicted from the processor by sending Evict transactions on the CHI write channel. However there are some cases where incorrect software can prevent an Evict transaction from being sent, therefore you must ensure that any external snoop filter is built to handle a capacity overflow that sends a back-invalidation to the processor if it runs out of storage.
Supported transactions	-	All transactions described by the CHI protocol: <ul style="list-style-type: none"> • Are accepted on the CHI master interface from the system. • Can be produced on the CHI master interface except: <ul style="list-style-type: none"> — ReadClean. — WriteBackPtl. — WriteCleanPtl.

See the *ARM® AMBA® 5 CHI Protocol Specification* for more information about the CHI channel.

7.4.4 CHI transaction IDs

Table 7-14 shows the CHI transaction IDs used for each type of transaction.

Table 7-14 CHI transactions

Transaction ID	Description
000nnxxx	Transaction from core nn. Can be a: <ul style="list-style-type: none"> • Read transaction. • Write transaction. • Cache maintenance transaction. • DVM transaction. • Barrier transaction.
001001xx	Transaction from the ACP interface. Can be a read or write.
00101110	Barrier generated in response to a DVM sync snoop from the interconnect.
0100xxxx	Eviction from L1 or L2 cache. The number of IDs used depends on the configuration.

7.4.5 CHI nodes

CHI transactions are sent to a specific node in the interconnect based on the:

- Type of access.
- Address of the access.
- Settings of the System Address Map.

Addresses that map to an HN-F node can be marked as cacheable memory in the page tables, and can take part in the cache coherency protocol. Addresses that map to an HN-I or MN must be marked as device or non-cacheable memory.

7.5 Additional memory attributes

The Cortex-A53 processor simplifies the coherency logic by downgrading some memory types:

- Memory that is marked as both Inner Write-Back Cacheable and Outer Write-Back Cacheable is cached in the L1 Data cache and the L2 cache.
- Memory that is marked Inner Write-Through is downgraded to Non-cacheable.
- Memory that is marked Outer Write-Through or Outer Non-cacheable is downgraded to Non-cacheable, even if the inner attributes are Write-Back cacheable.

The attributes provided on **ARCACHE** or **AWCACHE** in ACE configurations or MemAttr and SnpAttr in CHI configurations are these downgraded attributes, and indicate how the interconnect must treat the transaction.

Some interconnects or bus protocols might require more information about the memory type and, for these cases, the cluster exports the unaltered memory attribute information from the translation tables stored in the TLB. These signals are for information only, and do not form part of the ACE or CHI protocols.

In an ACE configuration there is a **RDMEMATTR** bus for the read channel and a **WRMEMATTR** bus for the write channel.

In a CHI configuration there is single **REQMEMATTR** bus.

Table 7-15 describes the encodings on the memory attribute bus.

Table 7-15 Memory attribute bus encodings

Bits	Encoding														
[7]	Outer shareable. Always set for device memory or memory that is both inner and outer non-cacheable.														
[6:3]	Outer memory type, or device type. If bits[1:0] indicate Device, then: <table border="0"> <tr> <td>0000</td> <td>nGnRnE.</td> </tr> <tr> <td>0100</td> <td>nGnRE.</td> </tr> <tr> <td>1000</td> <td>nGRE.</td> </tr> <tr> <td>1100</td> <td>GRE.</td> </tr> </table> If bits[1:0] indicate Normal, then: <table border="0"> <tr> <td>0100</td> <td>NC.</td> </tr> <tr> <td>10RW</td> <td>WT.</td> </tr> <tr> <td>11RW</td> <td>WB.</td> </tr> </table> Where R is read allocate hint, W is write allocate hint.	0000	nGnRnE.	0100	nGnRE.	1000	nGRE.	1100	GRE.	0100	NC.	10RW	WT.	11RW	WB.
0000	nGnRnE.														
0100	nGnRE.														
1000	nGRE.														
1100	GRE.														
0100	NC.														
10RW	WT.														
11RW	WB.														
[2]	Inner shareable. Anything with bit[7] set must also have bit[2] set.														
[1:0]	Inner memory type: <table border="0"> <tr> <td>00</td> <td>Device.</td> </tr> <tr> <td>01</td> <td>NC.</td> </tr> <tr> <td>10</td> <td>WT.</td> </tr> <tr> <td>11</td> <td>WB.</td> </tr> </table>	00	Device.	01	NC.	10	WT.	11	WB.						
00	Device.														
01	NC.														
10	WT.														
11	WB.														

7.6 Optional integrated L2 cache

The optional integrated L2 configurable caches sizes are 128KB, 256KB, 512KB, 1MB, and 2MB.

Data is allocated to the L2 cache only when evicted from the L1 memory system, not when first fetched from the system. The only exceptions to this rule are for memory marked with the inner transient hint, or for non-temporal loads, see [Non-temporal loads on page 6-12](#), that are only ever allocated to the L2 cache. The L1 cache can prefetch data from the system, without data being evicted from the L2 cache.

Instructions are allocated to the L2 cache when fetched from the system and can be invalidated during maintenance operations.

The L2 cache is 16-way set associative. The L2 cache tags are looked up in parallel with the SCU duplicate tags. If both the L2 tag and SCU duplicate tag hit, a read accesses the L2 cache in preference to snooping one of the other cores.

L2 RAMs are invalidated automatically at reset unless the **L2RSTDISABLE** signal is set HIGH when the **nL2RESET** signal is deasserted.

7.6.1 External aborts handling

The L2 memory system handles two types of external abort depending on the attributes of the memory region of the access:

- All load accesses use the synchronous abort mechanism.
- All STREX, STREXB, STREXH, STREXD, STXR, STXRB, STXRH, STXP, STLXR, STLXRB, STLXRH and STLXP instructions use the synchronous abort mechanism.
- All store accesses to Device memory, or Normal memory that is Inner Non-cacheable, Inner Write-Through, Outer Non-cacheable, or Outer Write-Through use the asynchronous abort mechanism, except for STREX, STREXB, STREXH, STREXD, STXR, STXRB, STXRH, STXP, STLXR, STLXRB, STLXRH, and STLXP.
- All store accesses to Normal memory that is both Inner Cacheable and Outer Cacheable and any evictions from L1 or L2 cache do not cause an abort in the processor, instead they assert the **nEXTERRIRQ** pin. This is because the access that aborts might not relate directly back to a specific core in the cluster.
- L2 linefills triggered by an L1 Instruction fetch assert the **nEXTERRIRQ** pin if the data is received from the interconnect in a dirty state. Instruction data can be marked as dirty as a result of self-modifying code or a line containing a mixture of data and instructions. If an error response is received on any part of the line, the dirty data might be lost.
- DVM operations that receive an error response use the asynchronous abort mechanism.

Note

When **nEXTERRIRQ** is asserted it remains asserted until the error is cleared by a write of 0 to the AXI or CHI asynchronous error bit of the L2ECTLR register.

7.7 ACP

The optional *Accelerator Coherency Port* (ACP) is implemented as an AXI4 slave interface with the following restrictions:

- 128-bit read and write interfaces.
- **ARCACHE** and **AWCACHE** are restricted to Normal, Write-Back, Read-Write-Allocate, Read-Allocate, Write-Allocate, and No-Allocate memory. **ARCACHE** and **AWCACHE** are limited to the values 0b0111, 0b1011, and 0b1111. Other values cause a SLVERR response on **RRESP** or **BRESP**.
- Exclusive accesses are not supported.
- Barriers are not supported. The **BRESP** handshake for a write transaction indicates global observability for that write.
- **ARSIZE** and **AWSIZE** signals are not present and assume a value of 0b100, 16 bytes.
- **ARBURST** and **AWBURST** signals are not present and assume a value of INCR.
- **ARLOCK** and **AWLOCK** signals are not present.
- **ARQOS** and **AWQOS** signals are not present.
- **ARLEN** and **AWLEN** are limited to values 0 and 3.

This section describes ACP in:

- [Transfer size support](#).
- [ACP user signals on page 7-20](#).
- [ACP performance on page 7-20](#).

7.7.1 Transfer size support

ACP supports the following read-request transfer size and length combinations:

- 64 byte INCR request characterized by:
 - **ARLEN** is 0x03, 4 beats.
 - **ARADDR** aligned to 64 byte boundary, so **ARADDR[5:0]** is 0b000000.
 - **ARSIZE** and **ARBURST** assume values of 0b100 and INCR respectively.
- 16 byte INCR request characterized by:
 - **ARLEN** is 0x00, 1 beat.
 - **ARADDR** aligned to 16 byte boundary, so **ARADDR[3:0]** is 0x0.

ACP supports the following write-request transfer size and length combinations:

- 64 byte INCR request characterized by:
 - **AWLEN** is 0x03, 4 beats.
 - **AWADDR** aligned to 64 byte boundary, so **AWADDR[5:0]** is 0b000000.
 - **AWSIZE** and **AWBURST** assume values of 0b100 and INCR respectively.
 - **WSTRB** for all beats must be the same and either all asserted or all deasserted.
- 16 byte INCR request characterized by:
 - **AWLEN** is 0x00, 1 beat.
 - **AWADDR** aligned to 16 byte boundary, so **AWADDR[3:0]** is 0x0.
 - **AWSIZE** and **AWBURST** assume values of 0b100 and INCR respectively.
 - **WSTRB** can take any value.

Requests not meeting these restrictions cause a SLVERR response on **RRESP** or **BRESP**.

7.7.2 ACP user signals

ACP transactions can cause coherent requests to the system. Therefore ACP requests must pass Inner and Outer Shareable attributes to the L2. To pass the shareability attribute, use the encodings described in [Table 7-16](#). See [ACP interface signals on page A-22](#) for more information.

Table 7-16 Shareability attribute encoding

AxUSER[1:0]	Attribute
0b00	Non-shareable
0b01	Inner Shareable
0b10	Outer Shareable

———— **Note** ————

This is the same encoding as AxDOMAIN on ACE, except that a value of 0b11 is not supported.

7.7.3 ACP performance

The ACP interface can support up to four outstanding transactions. These can be any combination of reads and writes.

The master must avoid sending more than one outstanding transaction on the same AXI ID, to prevent the second transaction stalling the interface until the first has completed. If the master requires explicit ordering between two transactions, ARM recommends that it waits for the response to the first transaction before sending the second transaction.

Writes are generally higher performance when they contain a full cache line of data.

If SCU cache protection is configured, writes of less than 64 bits incur an additional overhead of performing a read-modify-write sequence if they hit in the L2 cache.

Some L2 resources are shared between the ACP interface and the cores, therefore heavy traffic on the ACP interface might, in some cases, reduce the performance of the cores.

You can use the **ARCACHE** and **AWCACHE** signals to control whether the ACP request causes an allocation into the L2 cache if it misses. However if a CHI master interface is configured then, to ensure correct ordering of data beats, ACP reads that miss always allocate into the L2 cache.

Chapter 8

Cache Protection

This chapter describes the Cortex-A53 CPU cache protection. It contains the following sections:

- [Cache protection behavior on page 8-2.](#)
- [Error reporting on page 8-4.](#)

8.1 Cache protection behavior

The Cortex-A53 processor protects against soft errors that result in a RAM bitcell temporarily holding the incorrect value. The processor writes a new value to the RAM to correct the error. If the error is a hard error, that is not corrected by writing to the RAM, for example a physical defect in the RAM, then the processor might get into a livelock as it continually detects and then tries to correct the error.

Some RAMs have *Single Error Detect* (SED) capability, while others have *Single Error Correct, Double Error Detect* (SECEDED) capability. The L1 data cache dirty RAM is *Single Error Detect, Single Error Correct* (SEDSEC). The processor can make progress and remain functionally correct when there is a single bit error in any RAM. If there are multiple single bit errors in different RAMs, or within different protection granules within the same RAM, then the processor also remains functionally correct. If there is a double bit error in a single RAM within the same protection granule, then the behavior depends on the RAM:

- For RAMs with SECEDED capability listed in [Table 8-1](#), the error is detected and reported as described in [Error reporting on page 8-4](#). If the error is in a cache line containing dirty data, then that data might be lost, resulting in data corruption.
- For RAMs with only SED, a double bit error is not detected and therefore might cause data corruption.

If there are three or more bit errors, then depending on the RAM and the position of the errors within the RAM, the errors might be detected or might not be detected.

The Cortex-A53 CPU cache protection support has a minimal performance impact when no errors are present. When an error is detected, the access that caused the error is stalled while the correction takes place. When the correction is complete, the access either continues with the corrected data, or is retried. If the access is retried, it either hits in the cache again with the corrected data, or misses in the cache and re-fetches the data from a lower level cache or from main memory. The behavior for each RAM is shown in [Table 8-1](#).

Table 8-1 Cache protection behavior

RAM	Protection type	Configuration option	Protection granule	Correction behavior
L1 I-cache tag	Parity, SED	CPU_CACHE_PROTECTION	31 bits	Both lines in the cache set are invalidated, then the line requested is refetched from L2 or external memory.
L1 I-cache data	Parity, SED	CPU_CACHE_PROTECTION	20 bits	Both lines in the cache set are invalidated, then the line requested is refetched from L2 or external memory.
TLB	Parity, SED	CPU_CACHE_PROTECTION	31 bits or 52 bits	Entry invalidated, new pagewalk started to refetch it.
L1 D-cache tag	Parity, SED	CPU_CACHE_PROTECTION	32 bits	Line cleaned and invalidated from L1. SCU duplicate tags are used to get the correct address. Line refetched from L2 or external memory.
L1 D-cache data	ECC, SECEDED	CPU_CACHE_PROTECTION	32 bits	Line cleaned and invalidated from L1, with single bit errors corrected as part of the eviction. Line refetched from L2 or external memory.

Table 8-1 Cache protection behavior (continued)

RAM	Protection type	Configuration option	Protection granule	Correction behavior
L1 D-cache dirty	Parity, SEDSEC	CPU_CACHE_PROTECTION	1 bit	Line cleaned and invalidated from L1, with single bit errors corrected as part of the eviction. Only the dirty bit is protected. The other bits are performance hints, therefore do not cause a functional failure if they are incorrect.
SCU L1 duplicate tag	ECC, SECEDED	CPU_CACHE_PROTECTION	33 bits	Tag rewritten with correct value, access retried. If the error is uncorrectable then the tag is invalidated.
L2 tag	ECC, SECEDED	SCU_CACHE_PROTECTION	33 bits	Tag rewritten with correct value, access retried. If the error is uncorrectable then the tag is invalidated.
L2 victim	None	-	-	The victim RAM is used only as a performance hint. It does not result in a functional failure if the contents are incorrect.
L2 data	ECC, SECEDED	SCU_CACHE_PROTECTION	64 bits	Data is corrected inline, access might stall for an additional cycle or two while the correction takes place. After correction, the line might be evicted from the processor.
Branch predictor	None	-	-	The branch predictor RAMs are used only as a performance hint. They do not result in a functional failure if the contents are incorrect.

———— **Note** —————

If a correctable ECC error occurs after the first data cache access of a load instruction that takes multiple cycles to complete, for example LDM, and one of the following conditions has taken place:

- A hardware breakpoint, watchpoint or vector catch has been set since the first execution that is triggered on re-execution.
- The page tables have been modified since the first execution, resulting in an instruction or data abort trap being taken on re-execution.

The register file is updated with data that was successfully read, before the correctable ECC error occurred.

8.2 Error reporting

Any error that is detected is reported in the CPUMERRSR or L2MERRSR registers. See *CPU Memory Error Syndrome Register* on page 4-129 or *L2 Memory Error Syndrome Register* on page 4-132. Any error that is detected is also signalled on the PMUEVENT bus. See *Events* on page 12-36. This includes errors that are successfully corrected, and those that cannot be corrected. If multiple errors occur on the same clock cycle then only one of them is reported.

Errors that cannot be corrected, and therefore might result in data corruption, also cause an abort or external pin to be asserted, so that software can be aware that there is an error and can either attempt to recover or can restart the system:

- Uncorrectable errors in the L2 data RAM when read by an instruction fetch, TLB pagewalk, or load instruction, might result in a precise data abort or prefetch abort.
- Uncorrectable errors in the L1 or L2 data RAMs when the line is being evicted from a cache causes the **nINTERRIRQ** pin to be asserted. This might be because of a natural eviction, a cache maintenance operation, or a snoop.
- Uncorrectable errors in the L2 tag RAMs or SCU L1 duplicate tag RAMs causes the **nINTERRIRQ** pin to be asserted.

Note

- When **nINTERRIRQ** is asserted it remains asserted until the error is cleared by a write of 0 to the L2 internal asynchronous error bit of the L2ECTLR register.
 - ARM recommends that the **nINTERRIRQ** pin is connected to the interrupt controller so that an interrupt or system error is generated when the pin is asserted.
-

When a dirty cache line with an error on the data RAMs is evicted from the processor, the write on the master interface still takes place, however if the error is uncorrectable then:

- On ACE, the write strobes are not set, therefore the incorrect data is not written externally.
- On CHI, the strobes are set, but the response field indicates that there is a data error.

When a snoop hits on a line with an uncorrectable data error the data is returned, if required by the snoop, but the snoop response indicates that there is an error.

If a snoop hits on a tag that has an uncorrectable error, then it is treated as a snoop miss, because the error means that it is unknown if the cache line is valid or not.

Note

In some cases it is possible for an error to be counted more than once. For example, multiple accesses might read the location with the error before the line is evicted as part of the correction process.

Chapter 9

Generic Interrupt Controller CPU Interface

This chapter describes the Cortex-A53 processor implementation of the ARM *Generic Interrupt Controller (GIC)* CPU interface. It contains the following sections:

- *About the GIC CPU Interface* on page 9-2.
- *GIC programmers model* on page 9-3.

9.1 About the GIC CPU Interface

The GIC CPU Interface, when integrated with an external distributor component, is a resource for supporting and managing interrupts in a cluster system. It provides:

- Registers for managing:
 - Interrupt sources.
 - Interrupt behavior.
 - Interrupt routing to one or more cores.

The Cortex-A53 processor implements the GIC CPU interface as described in the Generic Interrupt Controller (GICv4) architecture. This interfaces with an external GICv3 or GICv4 interrupt distributor component within the system.

The GICv4 architecture supports:

- Two security states.
- Interrupt virtualization.
- *Software-generated Interrupts (SGIs)*.
- Message Based Interrupts.
- System register access.
- Memory-mapped register access.
- Interrupt masking and prioritization.
- Cluster environments, including systems that contain more than eight cores.
- Wake-up events in power management environments.

The GIC includes interrupt grouping functionality that supports:

- Signaling interrupt groups to the target core using either the IRQ or the FIQ exception request, based on software configuration.
- A unified scheme for handling the priority of Group 0 and Group 1 interrupts.

This chapter describes only features that are specific to the Cortex-A53 processor implementation.

9.1.1 Bypassing the CPU Interface

The GIC CPU Interface is always implemented within the Cortex-A53 processor. However, you can disable it if you assert the **GICCDISABLE** signal HIGH at reset. If the GIC is enabled, the input pins **nVIRQ** and **nVFIQ** must be tied off to HIGH. This is because the internal GIC CPU interface generates the virtual interrupt signals to the cores. The **nIRQ** and **nFIQ** signals are controlled by software, therefore there is no requirement to tie them HIGH. If you disable the GIC CPU interface, the input pins **nVIRQ** and **nVFIQ** can be driven by an external GIC in the SoC.

Disable the CPU Interface, when the Cortex-A53 processor is not being integrated with an external GICv3 or GICv4 distributor component in the system, by asserting the **GICCDISABLE** signal HIGH at reset.

Asserting the **GICCDISABLE** signal HIGH at reset removes access to the memory-mapped and system GIC CPU Interface registers.

9.2 GIC programmers model

This section describes the programmers model for the GIC CPU interface in:

- [CPU interface register summary](#).
- [CPU interface register descriptions on page 9-4](#).
- [Virtual interface control register summary on page 9-5](#).
- [Virtual interface control register descriptions on page 9-6](#).
- [Virtual CPU interface register summary on page 9-7](#).
- [Virtual CPU interface register descriptions on page 9-8](#).

9.2.1 Memory map

The Cortex-A53 GIC CPU Interface implements a memory-mapped interface. The memory-mapped interface is offset from **PERIPHBASE**. [Table 9-1](#) lists the address ranges.

Table 9-1 Memory Map

Address range	Functional block
0x00000-0x01FFF	CPU Interface
0x02000-0x0FFFF	Reserved
0x10000-0x10FFF	Virtual Interface Control
0x11000-0x1FFFF	Reserved
0x20000-0x21FFF	Virtual CPU Interface
0x22000-0x2EFFF	Reserved
0x2F000-0x30FFF	Alias of Virtual CPU Interface
0x31FFF-0x3FFFF	Reserved

———— **Note** ————

These registers are not available if **GICCDISABLE** is asserted.

9.2.2 CPU interface register summary

Each CPU interface block provides the interface for a Cortex-A53 processor that interfaces with a GIC distributor within the system. Each CPU interface provides a programming interface for:

- Enabling the signaling of interrupt requests by the CPU interface.
- Acknowledging an interrupt.
- Indicating completion of the processing of an interrupt.
- Setting an interrupt priority mask for the processor.
- Defining the preemption policy for the processor.
- Determining the highest priority pending interrupt for the processor.
- Generating SGIs.

For more information on the CPU interface, see the ARM *Generic Interrupt Controller Architecture Specification*.

[Table 9-2 on page 9-4](#) lists the registers for the CPU interface.

All the registers in [Table 9-2](#) are word-accessible. Registers not described in this table are RES0. See the *ARM® Generic Interrupt Controller Architecture Specification* for more information.

Table 9-2 CPU interface register summary

Name	Type	Reset	Description
GICC_CTLR	RW	0x00000000	CPU Interface Control Register
GICC_PMR	RW	0x00000000	Interrupt Priority Mask Register
GICC_BPR	RW	0x00000002 (S) ^a 0x00000003 (NS) ^b	Binary Point Register
GICC_IAR	RO	-	Interrupt Acknowledge Register
GICC_EOIR	WO	-	End Of Interrupt Register
GICC_RPR	RO	0x000000FF	Running Priority Register
GICC_HPPIR	RO	0x000003FF	Highest Priority Pending Interrupt Register
GICC_ABPR	RW	0x00000003	Aliased Binary Point Register
GICC_AIAR	RO	-	Aliased Interrupt Acknowledge Register
GICC_AEOIR	WO	-	Aliased End of Interrupt Register
GICC_AHPPIR	RO	0x000003FF	Aliased Highest Priority Pending Interrupt Register
GICC_APR0	RW	0x00000000	<i>Active Priority Register</i>
GICC_NSAPR0	RW	0x00000000	Non-secure Active Priority Register
GICC_IIDR	RO	0x0034243B	<i>CPU Interface Identification Register on page 9-5</i>
GICC_DIR	WO	-	Deactivate Interrupt Register

a. S = Secure.

b. NS = Non-secure.

9.2.3 CPU interface register descriptions

This section describes only registers whose implementation is specific to the Cortex-A53 processor. All other registers are described in the *ARM® Generic Interrupt Controller Architecture Specification*. [Table 9-2](#) provides cross-references to individual registers.

Active Priority Register

The GICC_APR0 characteristics are:

Purpose	Provides support for preserving and restoring state in power management applications.
Usage constraints	This register is banked to provide Secure and Non-secure copies. This ensures that Non-secure accesses do not interfere with Secure operation.
Configurations	Available in all configurations.
Attributes	See the register summary in Table 9-2 .

The Cortex-A53 processor implements the GICC_APR0 according to the recommendations described in the *ARM® Generic Interrupt Controller Architecture Specification*.

Table 9-3 shows the Cortex-A53 MPCore GICC_APR0 implementation.

Table 9-3 Active Priority Register implementation

Number of group priority bits	Preemption levels	Minimum legal value of Secure GICC_BPR	Minimum legal value of Non-secure GICC_BPR	Active Priority Registers implemented	View of Active Priority Registers for Non-secure accesses
5	32	2	3	GICC_APR0 [31:0]	GICC_NSAPR0 [31:16] appears as GICC_APR0 [15:0]

CPU Interface Identification Register

The GICC_IIDR characteristics are:

Purpose Provides information about the implementer and revision of the CPU interface.

Usage constraints There are no usage constraints.

Configurations Available in all configurations.

Attributes See the register summary in Table 9-2 on page 9-4.

Figure 9-1 shows the GICC_IIDR bit assignments.

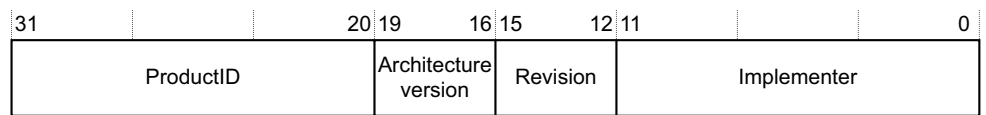

Figure 9-1 GICC_IIDR bit assignments

Table 9-4 shows the GICC_IIDR bit assignments.

Table 9-4 GICC_IIDR bit assignments

Bit	Name	Function
[31:20]	ProductID	Identifies the product: 0x03 Cortex-A53 processor.
[19:16]	Architecture version	Identifies the architecture version of the GICCPU Interface: 0x4 GICv4.
[15:12]	Revision	Identifies the revision number for the CPU interface: 0x2 r0p2.
[11:0]	Implementer	Contains the JEP106 code of the company that implements the CPU interface. For an ARM implementation, these values are: Bits[11:8] = 0x4 The JEP106 continuation code of the implementer. Bit[7] Always 0. Bits[6:0] = 0x3B The JEP106 identity code of the implementer.

9.2.4 Virtual interface control register summary

The virtual interface control registers are management registers. Configuration software on the Cortex-A53 processor must ensure they are accessible only by a hypervisor, or similar software.

Table 9-5 describes the registers for the virtual interface control registers.

All the registers in Table 9-5 are word-accessible. Registers not described in this table are RES0. See the *ARM® Generic Interrupt Controller Architecture Specification* for more information.

Table 9-5 Virtual interface control register summary

Name	Type	Reset	Description
GICH_HCR	RW	0x00000000	Hypervisor Control Register
GICH_VTR	RO	0x90000003	<i>VGIC Type Register</i>
GICH_VMCR	RW	0x004C0000	Virtual Machine Control Register
GICH_MISR	RO	0x00000000	Maintenance Interrupt Status Register
GICH_EISR0	RO	0x00000000	End of Interrupt Status Registers
GICH_ELSR0	RO	0x0000000F	Empty List Register Status Registers
GICH_APR0	RW	0x00000000	Active Priorities Register
GICH_LR0	RW	0x00000000	List Register 0
GICH_LR1	RW	0x00000000	List Register 1
GICH_LR2	RW	0x00000000	List Register 2
GICH_LR3	RW	0x00000000	List Register 3

9.2.5 Virtual interface control register descriptions

This section describes only registers whose implementation is specific to the Cortex-A53 processor. All other registers are described in the *ARM® Generic Interrupt Controller Architecture Specification*. Table 9-5 provides cross-references to individual registers.

VGIC Type Register

The GICH_VTR characteristics are:

Purpose	Holds information on number of priority bits, number of preemption bits, and number of List Registers implemented.
Usage constraints	There are no usage constraints.
Configurations	Available in all configurations.
Attributes	See the register summary in Table 9-5.

Figure 9-2 shows the GICH_VTR bit assignments.

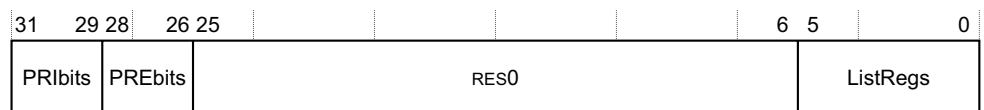

Figure 9-2 GICH_VTR bit assignments

Table 9-6 shows the GICH_VTR bit assignments.

Table 9-6 GICH_VTR bit assignments

Bit	Name	Description
[31:29]	PRIbits	Indicates the number of priority bits implemented, minus one: 0x4 Five bits of priority and 32 priority levels.
[28:26]	PREbits	Indicates the number of preemption bits implemented, minus one: 0x4 Five bits of preemption and 32 preemption levels.
[25:6]	-	Reserved, RES0.
[5:0]	ListRegs	Indicates the number of implemented List Registers, minus one: 0x3 Four List Registers.

9.2.6 Virtual CPU interface register summary

The virtual CPU interface forwards virtual interrupts to a connected Cortex-A53 processor, subject to the normal GIC handling and prioritization rules. The virtual interface control registers control virtual CPU interface operation, and in particular, the virtual CPU interface uses the contents of the List registers to determine when to signal virtual interrupts. When a core accesses the virtual CPU interface, the List registers are updated. For more information on the virtual CPU interface, see the *ARM® Generic Interrupt Controller Architecture Specification*.

Table 9-7 describes the registers for the virtual CPU interface.

All the registers in Table 9-7 are word-accessible. Registers not described in this table are RES0. See the *ARM® Generic Interrupt Controller Architecture Specification* for more information.

Table 9-7 Virtual CPU interface register summary

Name	Type	Reset	Description
GICV_CTLR	RW	0x00000000	VM Control Register
GICV_PMR	RW	0x00000000	VM Priority Mask Register
GICV_BPR	RW	0x00000002	VM Binary Point Register
GICV_IAR	RO	-	VM Interrupt Acknowledge Register
GICV_EOIR	WO	-	VM End Of Interrupt Register
GICV_RPR	RO	0x000000FF	VM Running Priority Register
GICV_HPPIR	RO	0x000003FF	VM Highest Priority Pending Interrupt Register
GICV_ABPR	RW	0x00000003	VM Aliased Binary Point Register
GICV_AIAR	RO	-	VM Aliased Interrupt Acknowledge Register
GICV_AEOIR	WO	-	VM Aliased End of Interrupt Register
GICV_AHPPIR	RO	0x000003FF	VM Aliased Highest Priority Pending Interrupt Register
GICV_APR0	RW	0x00000000	<i>VM Active Priority Register on page 9-8</i>
GICV_IIDR	RO	0x0034143B	<i>VM CPU Interface Identification Register on page 9-8</i>
GICV_DIR	WO	-	VM Deactivate Interrupt Register

9.2.7 Virtual CPU interface register descriptions

This section describes only registers whose implementation is specific to the Cortex-A53 processor. All other registers are described in the *ARM® Generic Interrupt Controller Architecture Specification*. [Table 9-7 on page 9-7](#) provides cross-references to individual registers.

VM Active Priority Register

The GICV_APR0 characteristics are:

Purpose	For software compatibility, this register is present in the virtual CPU interface. However, in a virtualized system, it is not used when preserving and restoring state.
Usage constraints	Reading the content of this register and then writing the same values must not change any state because there is no requirement to preserve and restore state during a powerdown.
Configurations	Available in all configurations.
Attributes	See the register summary in Table 9-7 on page 9-7 .

The Cortex-A53 processor implements the GICV_APR0 as an alias of GICH_APR0.

VM CPU Interface Identification Register

The GICV_IIDR characteristics are:

Purpose	Provides information about the implementer and revision of the virtual CPU interface.
Usage constraints	There are no usage constraints.
Configurations	Available in all configurations.
Attributes	See the register summary in Table 9-7 on page 9-7 .

The bit assignments for the VM CPU Interface Identification Register are identical to the corresponding register in the CPU interface, see [CPU Interface Identification Register on page 9-5](#).

Chapter 10

Generic Timer

This chapter describes the Cortex-A53 processor implementation of the ARM Generic Timer. It contains the following sections:

- *About the Generic Timer* on page 10-2.
- *Generic Timer functional description* on page 10-3.
- *Generic Timer register summary* on page 10-4.

10.1 About the Generic Timer

The Generic Timer can schedule events and trigger interrupts based on an incrementing counter value. It provides:

- Generation of timer events as interrupt outputs.
- Generation of event streams.

The Cortex-A53 MPCore Generic Timer is compliant with the *ARM® Architecture Reference Manual ARMv8, for ARMv8-A architecture profile*.

This chapter describes only features that are specific to the Cortex-A53 MPCore implementation.

10.2 Generic Timer functional description

The Cortex-A53 processor provides a set of timer registers within each core of the cluster. The timers are:

- An EL1 Non-secure physical timer.
- An EL1 Secure physical timer.
- An EL2 physical timer.
- A virtual timer.

The Cortex-A53 processor does not include the system counter. This resides in the SoC. The system counter value is distributed to the Cortex-A53 processor with a synchronous binary encoded 64-bit bus, **CNTVALUEB[63:0]**.

Because **CNTVALUEB** is generated from a system counter that typically operates at a slower frequency than the main processor **CLKIN**, the **CNTCLKEN** input is provided as a clock enable for the **CNTVALUEB** bus. **CNTCLKEN** is registered inside the Cortex-A53 processor before being used as a clock enable for the **CNTVALUEB[63:0]** registers. This allows a multicycle path to be applied to the **CNTVALUEB[63:0]** bus. [Figure 10-1](#) shows the interface.

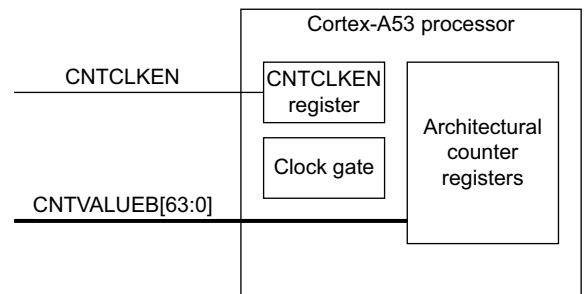

Figure 10-1 Architectural counter interface

The value on the **CNTVALUEB[63:0]** bus is required to be stable whenever the internally registered version of the **CNTCLKEN** clock enable is asserted. **CNTCLKEN** must be synchronous and balanced with **CLK** and must toggle at integer ratios of the processor **CLK**.

See [Clocks on page 2-9](#) for more information about **CNTCLKEN**.

Each timer provides an active-LOW interrupt output to the SoC.

[Table 10-1](#) shows the signals that are the external interrupt output pins.

Table 10-1 Generic Timer signals

Signal ^a	Description
nCNTPNSIRQ[n:0]	EL1 Non-secure physical timer event
nCNTPSIRQ[n:0]	EL1 Secure physical timer event
nCNTHPIRQ[n:0]	EL2 physical timer event
nCNTVIRQ[n:0]	Virtual timer event

a. **n** is the number of cores present in the cluster, minus one.

10.3 Generic Timer register summary

A set of Generic Timer registers are allocated within each core. The Generic Timer registers are either 32-bits wide or 64-bits wide and accessible in the AArch32 and AArch64 Execution states.

10.3.1 AArch64 Generic Timer register summary

Table 10-2 shows the AArch64 Generic Timer registers. See the *ARM® Architecture Reference Manual ARMv8, for ARMv8-A architecture profile* for information about these registers.

Table 10-2 AArch64 Generic Timer registers

Name	Op0	CRn	Op1	CRm	Op2	Reset	Width	Description
CNTKCTL_EL1	3	c14	0	c1	0	..a	32-bit	Counter-timer Kernel Control register
CNTFRQ_EL0			3	c0	0	UNK	32-bit	Counter-timer Frequency register
CNTPCT_EL0					1	UNK	64-bit	Counter-timer Physical Count register
CNTVCT_EL0					2	UNK	64-bit	Counter-timer Virtual Count register
CNTP_TVAL_EL0				c2	0	UNK	32-bit	Counter-timer Physical Timer TimerValue register
CNTP_CTL_EL0					1	..b	32-bit	Counter-timer Physical Timer Control register
CNTP_CVAL_EL0					2	UNK	64-bit	Counter-timer Physical Timer CompareValue register
CNTV_TVAL_EL0				c3	0	UNK	32-bit	Counter-timer Virtual Timer TimerValue register
CNTV_CTL_EL0					1	..b	32-bit	Counter-timer Virtual Timer Control register
CNTV_CVAL_EL0					2	UNK	64-bit	Counter-timer Virtual Timer CompareValue register
CNTVOFF_EL2			4	c0	3	UNK	64-bit	Counter-timer Virtual Offset register
CNTHCTL_EL2				c1	0	..c	32-bit	Counter-timer Hypervisor Control register
CNTHP_TVAL_EL2				c2	0	UNK	32-bit	Counter-timer Hypervisor Physical Timer TimerValue register
CNTHP_CTL_EL2					1	..b	32-bit	Counter-timer Hypervisor Physical Timer Control register
CNTHP_CVAL_EL2					2	UNK	64-bit	Counter-timer Hypervisor Physical Timer CompareValue register
CNTPS_TVAL_EL1			7	c2	0	UNK	32-bit	Counter-timer Physical Secure Timer TimerValue register
CNTPS_CTL_EL1					1	..b	32-bit	Counter-timer Physical Secure Timer Control register
CNTPS_CVAL_EL1					2	UNK	64-bit	Counter-timer Physical Secure Timer CompareValue register

a. The reset value for bits[9:8, 2:0] is `b00000`.

b. The reset value for bit[0] is 0.

- c. The reset value for bit[2] is 0 and for bits[1:0] is b11.

10.3.2 AArch32 Generic Timer register summary

Table 10-3 shows the AArch32 Generic Timer registers. See the *ARM® Architecture Reference Manual ARMv8, for ARMv8-A architecture profile* for information about these registers.

Table 10-3 AArch32 Generic Timer registers

Name	CRn	Op1	CRm	Op2	Reset	Width	Description
CNTFRQ	c14	0	c0	0	UNK	32-bit	Counter-timer Frequency register
CNTPCT	-	0	c14	-	UNK	64-bit	Counter-timer Physical Count register
CNTKCTL	c14	0	c1	0	-a	32-bit	Counter-timer Kernel Control register
CNTP_TVAL			c2	0	UNK	32-bit	Counter-timer Physical Timer TimerValue register
CNTP_CTL				1	-b	32-bit	Counter-timer Physical Timer Control register
CNTV_TVAL			c3	0	UNK	32-bit	Counter-timer Virtual Timer TimerValue register
CNTV_CTL				1	b	32-bit	Counter-timer Virtual Timer Control register
CNTVCT	-	1	c14	-	UNK	64-bit	Counter-timer Virtual Count register
CNTP_CVAL		2			UNK	64-bit	Counter-timer Physical Timer CompareValue register
CNTV_CVAL		3			UNK	64-bit	Counter-timer Virtual Timer CompareValue register
CNTVOFF		4			UNK	64-bit	Counter-timer Virtual Offset register
CNTHCTL	c14	4	c1	0	-c	32-bit	Counter-timer Hyp Control register
CNTHP_TVAL			c2	0	UNK	32-bit	Counter-timer Hyp Physical Timer TimerValue register
CNTHP_CTL				1	b	32-bit	Counter-timer Hyp Physical Timer Control register
CNTHP_CVAL	-	6	c14	-	UNK	64-bit	Counter-timer Hyp Physical CompareValue register

a. The reset value for bits[9:8, 2:0] is b00000.

b. The reset value for bit[0] is 0.

c. The reset value for bit[2] is 0 and for bits[1:0] is 0b11.

Chapter 11

Debug

This chapter describes the Cortex-A53 processor debug registers and shows examples of how to use them. It contains the following sections:

- *About debug* on page 11-2.
- *Debug register interfaces* on page 11-4.
- *AArch64 debug register summary* on page 11-6.
- *AArch64 debug register descriptions* on page 11-8.
- *AArch32 debug register summary* on page 11-15.
- *AArch32 debug register descriptions* on page 11-17.
- *Memory-mapped register summary* on page 11-21.
- *Memory-mapped register descriptions* on page 11-25.
- *Debug events* on page 11-36.
- *External debug interface* on page 11-37.
- *ROM table* on page 11-41.

11.1 About debug

This section gives an overview of debug and describes the debug components. The processor forms one component of a debug system.

The following methods of debugging an ARM processor based SoC exist:

Conventional JTAG debug ('external' debug)

This is invasive debug with the core halted using:

- Breakpoints and watchpoints to halt the core on specific activity.
- A debug connection to examine and modify registers and memory, and provide single-step execution.

Conventional monitor debug ('self-hosted' debug)

This is invasive debug with the core running using a debug monitor that resides in memory.

Figure 11-1 shows a typical external debug system.

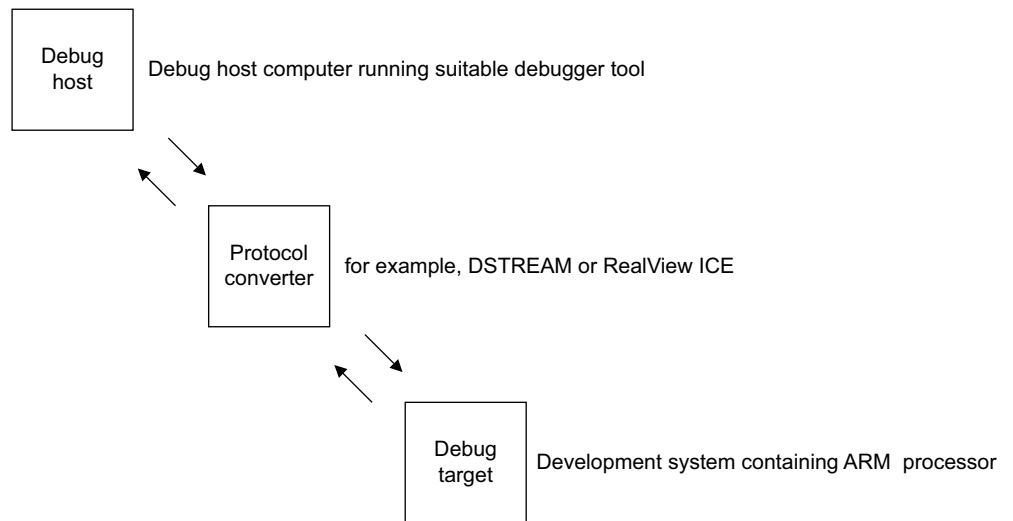

Figure 11-1 Typical debug system

This typical system has several parts:

- [Debug host](#).
- [Protocol converter](#) on page 11-3.
- [Debug target](#) on page 11-3.
- [The debug unit](#) on page 11-3.
- [Self-hosted debug](#) on page 11-3.

11.1.1 Debug host

The debug host is a computer, for example a personal computer, running a software debugger such as the DS-5 Debugger. The debug host enables you to issue high-level commands such as setting breakpoint at a certain location, or examining the contents of a memory address.

11.1.2 Protocol converter

The debug host sends messages to the debug target using an interface such as Ethernet. However, the debug target typically implements a different interface protocol. A device such as DSTREAM is required to convert between the two protocols.

11.1.3 Debug target

The debug target is the lowest level of the system. An example of a debug target is a development system with a test chip or a silicon part with a processor.

The debug target implements system support for the protocol converter to access the debug unit using the *Advanced Peripheral Bus* (APB) slave interface.

11.1.4 The debug unit

The processor debug unit assists in debugging software running on the processor. You can use the processor debug unit, in combination with a software debugger program, to debug:

- Application software.
- Operating systems.
- Hardware systems based on an ARM processor.

The debug unit enables you to:

- Stop program execution.
- Examine and alter process and coprocessor state.
- Examine and alter memory and input/output peripheral state.
- Restart the processor.

11.1.5 Self-hosted debug

For self-hosted debug, the debug target runs additional debug monitor software that runs on the Cortex-A53 processor itself, rather than requiring expensive interface hardware to connect a second host computer.

11.2 Debug register interfaces

The processor implements the ARMv8 Debug architecture and debug events as described in the *ARM® Architecture Reference Manual ARMv8, for ARMv8-A architecture profile*.

The Debug architecture defines a set of debug registers. The debug register interfaces provide access to these registers from:

- Software running on the processor.
- An external debugger.

This section describes:

- [Processor interfaces](#).
- [Effects of resets on debug registers](#).
- [External access permissions on page 11-5](#).

11.2.1 Processor interfaces

System register access allows the processor to directly access certain debug registers. The external debug interface, see [External debug interface on page 11-37](#), enables both external and self-hosted debug agents to access debug registers. Access to the debug registers is partitioned as follows:

Debug registers

This function is system register based and memory-mapped. You can access the debug register map using the APB slave port. See [External debug interface on page 11-37](#).

Performance monitor

This function is system register based and memory-mapped. You can access the performance monitor registers using the APB slave port. See [External debug interface on page 11-37](#).

Trace registers

This function is memory-mapped. See [External debug interface on page 11-37](#).

Cross Trigger Interface registers

This function is debug register based and memory-mapped. See [Chapter 14 Cross Trigger](#).

11.2.2 Effects of resets on debug registers

The processor has the following reset signals that affect the debug registers:

nCPUPORESET

This signal initializes the processor logic, including the debug, *Embedded Trace Macrocell* (ETM) trace unit, breakpoint, watchpoint logic, and performance monitors logic. This maps to a cold reset that covers reset of the processor logic and the integrated debug functionality.

nCORERESET

This signal resets some of the debug and performance monitor logic. This maps to a warm reset that covers reset of the processor logic.

nPRESETDBG

This signal initializes the shared debug APB, *Cross Trigger Interface (CTI)*, and *Cross Trigger Matrix (CTM)* logic. This maps to an external debug reset that covers the resetting of the external debug interface and has no impact on the processor functionality.

11.2.3 External access permissions

External access permission to the debug registers is subject to the conditions at the time of the access. [Table 11-1](#) describe the processor response to accesses through the external debug interface.

Table 11-1 External register conditions

Name	Condition	Description
Off	EDPRSR.PU is 0	Processor power domain is completely off, or in a low-power state where the processor power domain registers cannot be accessed. <div style="text-align: center;"> <p>———— Note ————</p> <p>If debug power is off then all external debug and memory-mapped register accesses return an error.</p> </div>
DLK	EDPRSR.DLK is 1	OS Double Lock is locked.
OSLK	OSLSR_EL1.OSLK is 1	OS Lock is locked.
EDAD	AllowExternalDebugAccess() ==FALSE	External debug access is disabled. When an error is returned because of an EDAD condition code, and this is the highest priority error condition, EDPRSR.SDAD is set to 1. Otherwise SDAD is unchanged.
SLK	Memory-mapped interface only	Software lock is locked. For the external debug interface, ignore this column.
Default	-	None of the conditions apply, normal access.

[Table 11-2](#) shows an example of external register condition codes for access to a performance monitor register. To determine the access permission for the register, scan the columns from left to right. Stop at the first column a condition is true, the entry gives the access permission of the register and scanning stops.

Table 11-2 External register condition code example

Off	DLK	OSLK	EDAD	SLK	Default
-	-	-	-	RO/WI	RO

11.3 AArch64 debug register summary

Table 11-3 summarizes debug control registers that are accessible in the AArch64 Execution state. These registers are accessed by the MRS and MSR instructions in the order of Op0, CRn, Op1, CRm, Op2.

See the *Memory-mapped register summary* on page 11-21 for a complete list of registers accessible from the internal memory-mapped or the external debug interface. The 64-bit registers cover two addresses on the external memory interface. For those registers not described in this chapter, see the *ARM® Architecture Reference Manual ARMv8, for ARMv8-A architecture profile*.

Table 11-3 AArch64 debug register summary

Name	Type	Reset	Width	Description
OSDTRRX_EL1	RW	-	32	Debug Data Transfer Register, Receive, External View
DBGBVR0_EL1	RW	-	64	Debug Breakpoint Value Register 0
DBGBCR0_EL1	RW	-	32	<i>Debug Breakpoint Control Registers, EL1 on page 11-8</i>
DBGWVR0_EL1	RW	-	64	Debug Watchpoint Value Register 0
DBGWCR0_EL1	RW	-	32	<i>Debug Watchpoint Control Registers, EL1 on page 11-11</i>
DBGBVR1_EL1	RW	-	64	Debug Breakpoint Value Register 1
DBGBCR1_EL1	RW	-	32	<i>Debug Breakpoint Control Registers, EL1 on page 11-8</i>
DBGWVR1_EL1	RW	-	64	Debug Watchpoint Value Register 1
DBGWCR1_EL1	RW	-	32	<i>Debug Watchpoint Control Registers, EL1 on page 11-11</i>
MDCCINT_EL1	RW	0x00000000	32	Monitor Debug Comms Channel Interrupt Enable Register
MDSR_EL1	RW	-	32	Monitor Debug System Register
DBGBVR2_EL1	RW	-	64	Debug Breakpoint Value Register 2
DBGBCR2_EL1	RW	-	32	<i>Debug Breakpoint Control Registers, EL1 on page 11-8</i>
DBGWVR2_EL1	RW	-	64	Debug Watchpoint Value Register 2
DBGWCR2_EL1	RW	-	32	<i>Debug Watchpoint Control Registers, EL1 on page 11-11</i>
OSDTRTX_EL1	RW	-	32	Debug Data Transfer Register, Transmit, External View
DBGBVR3_EL1	RW	-	64	Debug Breakpoint Value Register 3
DBGBCR3_EL1	RW	-	32	<i>Debug Breakpoint Control Registers, EL1 on page 11-8</i>
DBGWVR3_EL1	RW	-	64	Debug Watchpoint Value Register 3
DBGWCR3_EL1	RW	-	32	<i>Debug Watchpoint Control Registers, EL1 on page 11-11</i>
DBGBVR4_EL1	RW	-	64	Debug Breakpoint Value Register 4
DBGBCR4_EL1	RW	-	32	<i>Debug Breakpoint Control Registers, EL1 on page 11-8</i>
DBGBVR5_EL1	RW	-	64	Debug Breakpoint Value Register 5
DBGBCR5_EL1	RW	-	32	<i>Debug Breakpoint Control Registers, EL1 on page 11-8</i>
OSECRR_EL1	RW	-	32	Debug OS Lock Exception Catch Register

Table 11-3 AArch64 debug register summary (continued)

Name	Type	Reset	Width	Description
MDCCSR_EL0	RO	-	32	Monitor Debug Comms Channel Status Register
DBGDTR_EL0	RW	-	64	Debug Data Transfer Register, half-duplex
DBGDTRTX_EL0	WO	-	32	Debug Data Transfer Register, Transmit, Internal View
DBGDTRRX_EL0	RO	-	32	Debug Data Transfer Register, Receive, Internal View
DBGVCR32_EL2	RW	-	32	Debug Vector Catch Register
MDRAR_EL1	RO	a	64	Debug ROM Address Register
OSLAR_EL1	WO	-	32	Debug OS Lock Access Register
OSLSR_EL1	RO	0x0000000A	32	Debug OS Lock Status Register
OSDLR_EL1	RW	0x00000000	32	Debug OS Double Lock Register
DBGPRCR_EL1	RW	-	32	Debug Power/Reset Control Register
DBGCLAIMSET_EL1	RW	0x000000FF	32	Debug Claim Tag Set Register
DBGCLAIMCLR_EL1	RW	0x00000000	32	Debug Claim Tag Clear Register
DBGAUTHSTATUS_EL1	RO	-	32	Debug Authentication Status Register

a. Resets to the physical address of the ROM table +3.

11.4 AArch64 debug register descriptions

This section describes the debug registers in the AArch64 Execution state. The [AArch64 debug register summary on page 11-6](#) provides cross-references to the individual registers.

11.4.1 Debug Breakpoint Control Registers, EL1

The $DBGBCR_n_{EL1}$ characteristics are:

Purpose Holds control information for a breakpoint. Each $DBGBVR_{EL1}$ is associated with a $DBGBCR_{EL1}$ to form a *Breakpoint Register Pair* (BRP). $DBGBVR_n_{EL1}$ is associated with $DBGBCR_n_{EL1}$ to form BRP_n .

———— **Note** —————

The range of n for $DBGBCR_n_{EL1}$ is 0 to 5.

Usage constraints These registers are accessible as follows:

EL0	EL1 (NS)	EL1 (S)	EL2	EL3 (SCR.NS = 1)	EL3 (SCR.NS = 0)
-	RW	RW	RW	RW	RW

Configurations $DBGBCR_n_{EL1}$ are architecturally mapped to:

- The AArch32 $DBGBCR_n$ registers.
- The external $DBGBCR_n_{EL1}$ registers.

Attributes See the register summary in [Table 11-3 on page 11-6](#).

The debug logic reset value of a $DBGBCR_n_{EL1}$ is UNKNOWN.

[Figure 11-2](#) shows the $DBGBCR_n_{EL1}$ bit assignments.

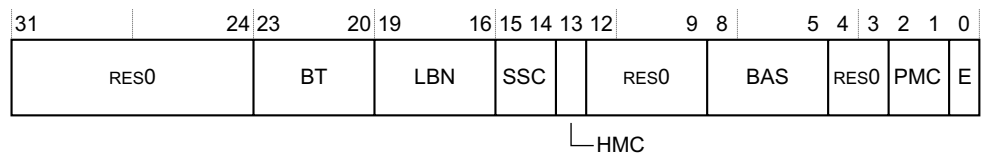

Figure 11-2 $DBGBCR_n_{EL1}$ bit assignments

Table 11-4 shows the DBGBCR $_n$ _EL1 bit assignments.

Table 11-4 DBGBCR $_n$ _EL1 bit assignments

Bits	Name	Function
[31:24]	-	Reserved, RES0.
[23:20]	BT	<p>Breakpoint Type. This field controls the behavior of Breakpoint debug event generation. This includes the meaning of the value held in the associated DBGBVR, indicating whether it is an instruction address match or mismatch or a Context match. It also controls whether the breakpoint is linked to another breakpoint. The possible values are:</p> <p>0b0000 Unlinked instruction address match. 0b0001 Linked instruction address match. 0b0010 Unlinked ContextIDR match. 0b0011 Linked ContextIDR match. 0b0100 Unlinked instruction address mismatch. 0b0101 Linked instruction address mismatch. 0b1000 Unlinked VMID match. 0b1001 Linked VMID match. 0b1010 Unlinked VMID + CONTEXTIDR match. 0b1011 Linked VMID + CONTEXTIDR match.</p> <p>All other values are reserved. The field break down is:</p> <ul style="list-style-type: none"> BT[3:1]: Base type. If the breakpoint is not context-aware, these bits are RES0. Otherwise, the possible values are: <ul style="list-style-type: none"> 0b000 Match address. DBGBVR$_n$_EL1 is the address of an instruction. 0b001 Match context ID. DBGBVR$_n$_EL1[31:0] is a context ID. 0b010 Address mismatch. Mismatch address. Behaves as type 0b000 if either: <ul style="list-style-type: none"> In an AArch64 translation regime. Halting debug-mode is enabled and halting is allowed. Otherwise, DBGBVR$_n$_EL1 is the address of an instruction to be stepped. 0b100 Match VMID. DBGBVR$_n$_EL1[39:32] is a VMID. 0b101 Match VMID and context ID. DBGBVR$_n$_EL1[31:0] is a context ID, and DBGBVR$_n$_EL1[39:32] is a VMID. BT[0]: Enable linking.
[19:16]	LBN	Linked breakpoint number. For Linked address matching breakpoints, this specifies the index of the Context-matching breakpoint linked to.
[15:14]	SSC	<p>Security State Control. Determines the security states that a breakpoint debug event for breakpoint n is generated. This field must be interpreted with the <i>Higher Mode Control</i> (HMC), and <i>Privileged Mode Control</i> (PMC), fields to determine the mode and security states that can be tested.</p> <p>See the <i>ARM® Architecture Reference Manual ARMv8, for ARMv8-A architecture profile</i> for possible values of the fields.</p>
[13]	HMC	<p>Hyp Mode Control bit. Determines the debug perspective for deciding when a breakpoint debug event for breakpoint n is generated.</p> <p>This bit must be interpreted with the SSC and PMC fields to determine the mode and security states that can be tested.</p> <p>See the <i>ARM® Architecture Reference Manual ARMv8, for ARMv8-A architecture profile</i> for possible values of the fields.</p>
[12:9]	-	Reserved, RES0.

Table 11-4 DBGBCR_n_EL1 bit assignments (continued)

Bits	Name	Function
[8:5]	BAS ^a	<p>Byte Address Select. Defines which half-words a regular breakpoint matches, regardless of the instruction set and execution state. A debugger must program this field as follows:</p> <p>0x3 Match the T32 instruction at DBGBVR_n.</p> <p>0xC Match the T32 instruction at DBGBVR_n+2.</p> <p>0xF Match the A64 or A32 instruction at DBGBVR_n, or context match.</p> <p>All other values are reserved.</p> <p style="text-align: center;">Note</p> <p>The ARMv8-A architecture does not support direct execution of Java bytecodes. BAS[3] and BAS[1] ignore writes and on reads return the values of BAS[2] and BAS[0] respectively.</p>
[4:3]	-	Reserved, RES0.
[2:1]	PMC	<p>Privileged Mode Control. Determines the exception level or levels that a breakpoint debug event for breakpoint <i>n</i> is generated.</p> <p>This field must be interpreted with the SSC and HMC fields to determine the mode and security states that can be tested.</p> <p>See the <i>ARM® Architecture Reference Manual ARMv8, for ARMv8-A architecture profile</i> for possible values of the fields.</p> <p style="text-align: center;">Note</p> <p>Bits[2:1] have no effect for accesses made in Hyp mode.</p>
[0]	E	<p>Enable breakpoint. This bit enables the BRP:</p> <p>0 BRP disabled.</p> <p>1 BRP enabled.</p> <p>A BRP never generates a breakpoint debug event when it is disabled.</p> <p style="text-align: center;">Note</p> <p>The value of DBGBCR.E is UNKNOWN on reset. A debugger must ensure that DBGBCR.E has a defined value before it programs DBGDSCR.MDBGen and DBGDSCR.HDBGen to enable debug.</p>

- a. See the *ARM® Architecture Reference Manual ARMv8, for ARMv8-A architecture profile* for more information on how the BAS field is interpreted by hardware.

To access the DBGBCR_n_EL1 in AArch64 Execution state, read or write the register with:

MRS <Xt>, DBGBCR_n_EL1; Read Debug Breakpoint Control Register *n*
 MSR DBGBCR_n_EL1, <Xt>; Write Debug Breakpoint Control Register *n*

To access the DBGBCR_n in AArch32 Execution state, read or write the CP14 register with:

MRC p14, 0, <Rt>, c0, cn, 4; Read Debug Breakpoint Control Register *n*
 MCR p14, 0, <Rt>, c0, cn, 4; Write Debug Breakpoint Control Register *n*

The DBGBCR_n_EL1 can be accessed through the internal memory-mapped interface and the external debug interface, offset 0x4n8.

11.4.2 Debug Watchpoint Control Registers, EL1

The $DBGWCR_n_EL1$ characteristics are:

Purpose Holds control information for a watchpoint. Each $DBGWCR_EL1$ is associated with a $DBGWVR_EL1$ to form a *Watchpoint Register Pair* (WRP). $DBGWCR_n_EL1$ is associated with $DBGWVR_n_EL1$ to form WRP_n .

———— **Note** —————

The range of n for $DBGWCR_n_EL1$ is 0 to 3.

Usage constraints These registers are accessible as follows:

EL0	EL1 (NS)	EL1 (S)	EL2	EL3 (SCR.NS = 1)	EL3 (SCR.NS = 0)
-	RW	RW	RW	RW	RW

Configurations The $DBGWCR_n_EL1$ is architecturally mapped to:

- The AArch32 $DBGWCR_n$ registers.
- The external $DBGWCR_n_EL1$ registers.

Attributes See the register summary in [Table 11-3 on page 11-6](#).

The debug logic reset value of a $DBGWCR_EL1$ is UNKNOWN.

[Figure 11-3](#) shows the $DBGWCR_n_EL1$ bit assignments.

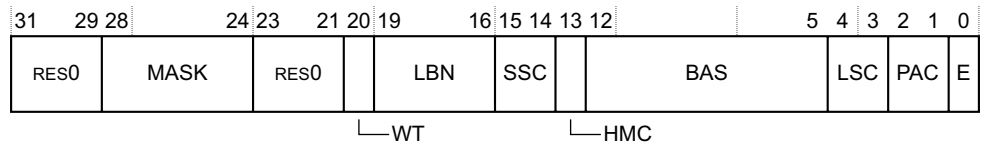

Figure 11-3 $DBGWCR_n_EL1$ bit assignments

[Table 11-5](#) shows the $DBGWCR_n_EL1$ bit assignments.

Table 11-5 $DBGWCR_n_EL1$ bit assignments

Bits	Name	Function
[31:29]	-	Reserved, RES0.
[28:24]	MASK	Address range mask. The processor supports watchpoint address range masking. This field can set a watchpoint on a range of addresses by masking lower order address bits out of the watchpoint comparison. The value of this field is the number of low order bits of the address that are masked off, except that values of 1 and 2 are reserved. See the <i>ARM® Architecture Reference Manual ARMv8, for ARMv8-A architecture profile</i> for the meanings of watchpoint address range mask values.
[23:21]	-	Reserved, RES0.

Table 11-5 DBGWCRn_EL1 bit assignments (continued)

Bits	Name	Function
[20]	WT	<p>Watchpoint Type. This bit is set to 1 to link the watchpoint to a breakpoint to create a linked watchpoint that requires both data address matching and Context matching:</p> <p>0 Unlinked data address match.</p> <p>1 Linked data address match.</p> <p>When this bit is set to 1 the linked BRP number field indicates the BRP that this WRP is linked. See the <i>ARM® Architecture Reference Manual ARMv8, for ARMv8-A architecture profile</i> for more information.</p>
[19:16]	LBN	<p>Linked Breakpoint Number. If this watchpoint is programmed with the watchpoint type set to linked, then this field must be programmed with the number of the breakpoint that defines the Context match to be combined with data address comparison. Otherwise, this field must be programmed to b0000.</p> <p>Reading this register returns an UNKNOWN value for this field, and the generation of Watchpoint debug events is UNPREDICTABLE, if either:</p> <ul style="list-style-type: none"> • This watchpoint does not have linking enabled and this field is not programmed to 0x0. • This watchpoint has linking enabled and the breakpoint indicated by this field does not support Context matching, is not programmed for Context matching, or does not exist. <p>See the <i>ARM® Architecture Reference Manual ARMv8, for ARMv8-A architecture profile</i> for more information.</p>
[15:14]	SSC	<p>Security State Control. This field enables the watchpoint to be conditional on the security state of the processor. This field is used with the <i>Hyp Mode Control (HMC)</i> and <i>Privileged Access Control (PAC)</i> fields.</p> <p>See the <i>ARM® Architecture Reference Manual ARMv8, for ARMv8-A architecture profile</i> for possible values of the fields, and the access modes and security states that can be tested.</p>
[13]	HMC	<p>Hyp Mode Control. This field is used with the <i>Security State Control (SSC)</i> and <i>PAC</i> fields. The value of DBGWCR.PAC has no effect for accesses made in Hyp mode.</p> <p>See the <i>ARM® Architecture Reference Manual ARMv8, for ARMv8-A architecture profile</i> for possible values of the fields, and the access modes and security states that can be tested.</p>
[12:5]	BAS	<p>Byte Address Select. The processor implements an 8-bit Byte address select field, DBGWCR[12:5]. A DBGWVR is programmed with a word-aligned address. This field enables the watchpoint to hit only if certain bytes of the addressed word are accessed. The watchpoint hits if an access hits any byte being watched, even if:</p> <ul style="list-style-type: none"> • The access size is larger than the size of the region being watched. • The access is unaligned, and the base address of the access is not in the same word of memory as the address in the DBGWVR. • The access size is smaller than the size of region being watched. <p>See the <i>ARM® Architecture Reference Manual ARMv8, for ARMv8-A architecture profile</i> for more information.</p>

Table 11-5 DBGWCR_n_EL1 bit assignments (continued)

Bits	Name	Function
[4:3]	LSC	Load/store access control. This field enables watchpoint matching for the type of access. The possible values are: 0b00 Reserved. 0b01 Match on any load, Load-Exclusive, or swap. 0b10 Match on any store, Store-Exclusive or swap. 0b11 Match on all type of access.
[2:1]	PAC	Privileged Access Control. This field enables watchpoint matching conditional on the mode of the processor. This field is used with the SSC and PAC fields. See the <i>ARM® Architecture Reference Manual ARMv8, for ARMv8-A architecture profile</i> for possible values of the fields, and the access modes and security states that can be tested. <hr/> Note <ul style="list-style-type: none"> For all cases the match refers to the privilege level of the access, not the mode of the processor. For example, if the watchpoint is configured to match only accesses at PL1 or higher, and the processor executes an LDRT instruction in a PL1 mode, the watchpoint does not match. Permitted values of this field are not identical to those for the DBGBCR. In the DBGBCR the value b00 permitted. <hr/>
[0]	E	Watchpoint Enable. This bit enables the watchpoint: 0 Watchpoint disabled. 1 Watchpoint enabled. A watchpoint never generates a Watchpoint debug event when it is disabled. <hr/> Note The value of DBGWCR.E is UNKNOWN on reset. A debugger must ensure that DBGWCR.E has a defined value before it programs DBGDSCR[15:14] to enable debug. <hr/>

To access the DBGWCR_n in AArch32 Execution state, read or write the CP14 register with:

```
MRC p14, 0, <Rt>, c0, cn, 7; Read Debug Watchpoint Control Register n
MCR p14, 0, <Rt>, c0, cn, 7; Write Debug Watchpoint Control Register n
```

To access the DBGWCR_n_EL1 in AArch64 Execution state, read or write the register with:

```
MRS <Xt>, DBGWCRn_EL1; Read Debug Watchpoint Control Register n
MSR DBGWCRn_EL1, <Xt>; Write Debug Watchpoint Control Register n
```

The DBGWCR_n_EL1 can be accessed through the internal memory-mapped interface and the external debug interface, offset 0x8n8. The range of *n* for DBGWCR_n_EL1 is 0 to 3.

11.4.3 Debug Claim Tag Set register

The DBGCLAIMSET_EL1 characteristics are:

Purpose Used by software to set CLAIM bits to 1.

Usage constraints This register is accessible as follows:

EL0	EL1 (NS)	EL1 (S)	EL2	EL3 (SCR.NS = 1)	EL3 (SCR.NS = 0)
-	RW	RW	RW	RW	RW

Configurations DBGCLAIMSET_EL1 is architecturally mapped to:

- The AArch32 register DBGCLAIMSET.
- The external register DBGCLAIMSET_EL1.

Attributes DBGCLAIMSET_EL1 is a 32-bit register.

Figure 11-2 on page 11-8 shows the DBGCLAIMSET_EL1 bit assignments.

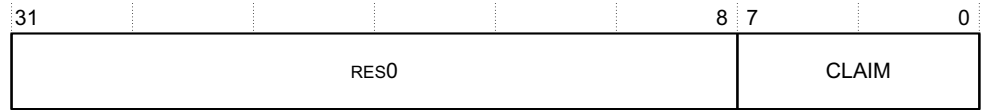

Figure 11-4 DBGCLAIMSET_EL1 bit assignments

Table 11-4 on page 11-9 shows the DBGCLAIMSET_EL1 bit assignments.

Table 11-6 DBGCLAIMSET_EL1 bit assignments

Bits	Name	Function
[31:8]	-	Reserved, RES0.
[7:0]	CLAIM	Claim set bits. Writing a 1 to one of these bits sets the corresponding CLAIM bit to 1. This is an indirect write to the CLAIM bits. A single write operation can set multiple bits to 1. Writing 0 to one of these bits has no effect.

To access the DBGCLAIMSET_EL1 in AArch64 Execution state, read or write the register with:

```
MRS <Xt>, DBGCLAIMSET_EL1 ; Read DBGCLAIMSET_EL1 into Xt
MSR DBGCLAIMSET_EL1, <Xt> ; Write Xt to DBGCLAIMSET_EL1
```

The DBGCLAIMSET_EL1 can be accessed through the internal memory-mapped interface and the external debug interface, offset 0xFA0.

11.5 AArch32 debug register summary

Table 11-7 summarizes the 32-bit and 64-bit debug control registers that are accessible in the AArch32 Execution state from the internal CP14 interface. These registers are accessed by the MCR and MRC instructions in the order of CRn, op2, CRm, Op1 or MCRR and MRRC instructions in the order of CRm, Op1. For those registers not described in this chapter, see the *ARM® Architecture Reference Manual ARMv8, for ARMv8-A architecture profile*.

See the *Memory-mapped register summary* on page 11-21 for a complete list of registers accessible from the internal memory-mapped and the external debug interface.

Table 11-7 AArch32 debug register summary

Offset	CRn	Op2	CRm	Op1	Name	Type	Description
-	c0	0	c0	0	DBGDIDR	RO	Debug ID Register on page 11-17
-	c0	0	c1	0	DBGDSCRint	RO	Debug Status and Control Register, Internal View
-	c0	0	c2	0	DBGDCCINT	RW	Debug Comms Channel Interrupt Enable Register
0x08C	c0	0	c5	0	DBGDTRXint	WO	Debug Data Transfer Register, Transmit, Internal View
					DBGDTRRXint	RO	Debug Data Transfer Register, Receive, Internal View
-	c0	0	c6	0	DBGWFAR ^a	RW	Watchpoint Fault Address Register, RES0
-	c0	0	c7	0	DBGVCR	RW	Debug Vector Catch Register
-	c0	2	c0	0	DBGDTRRXext	RW	Debug Data Transfer Register, Receive, External View
-	c0	2	c2	0	DBGDSCRext	RW	Debug Status and Control Register, External View
-	c0	2	c3	0	DBGDTRTXext	RW	Debug Data Transfer Register, Transmit, External View
0x098	c0	2	c6	0	DBGOSECCR	RW	Debug OS Lock Exception Catch Control Register
0x400	c0	4	c0	0	DBGBVR0	RW	Debug Breakpoint Value Register 0
0x410	c0	4	c1	0	DBGBVR1	RW	Debug Breakpoint Value Register 1
0x420	c0	4	c2	0	DBGBVR2	RW	Debug Breakpoint Value Register 2
0x430	c0	4	c3	0	DBGBVR3	RW	Debug Breakpoint Value Register 3
0x440	c0	4	c4	0	DBGBVR4	RW	Debug Breakpoint Value Register 4
0x450	c0	4	c5	0	DBGBVR5	RW	Debug Breakpoint Value Register 5
0x408	c0	5	c0	0	DBGBCR0	RW	Debug Breakpoint Control Registers, EL1 on page 11-8
0x418	c0	5	c1	0	DBGBCR1	RW	Debug Breakpoint Control Registers, EL1 on page 11-8
0x428	c0	5	c2	0	DBGBCR2	RW	Debug Breakpoint Control Registers, EL1 on page 11-8
0x438	c0	5	c3	0	DBGBCR3	RW	Debug Breakpoint Control Registers, EL1 on page 11-8
0x448	c0	5	c4	0	DBGBCR4	RW	Debug Breakpoint Control Registers, EL1 on page 11-8

Table 11-7 AArch32 debug register summary (continued)

Offset	CRn	Op2	CRm	Op1	Name	Type	Description
0x458	c0	5	c5	0	DBGBCR5	RW	<i>Debug Breakpoint Control Registers, EL1 on page 11-8</i>
0x800	c0	6	c0	0	DBGWVR0	RW	Debug Watchpoint Value Register 0
0x810	c0	6	c1	0	DBGWVR1	RW	Debug Watchpoint Value Register 1
0x820	c0	6	c2	0	DBGWVR2	RW	Debug Watchpoint Value Register 2
0x830	c0	6	c3	0	DBGWVR3	RW	Debug Watchpoint Value Register 3
0x808	c0	7	c0	0	DBGWCR0	RW	<i>Debug Watchpoint Control Registers, EL1 on page 11-11</i>
0x818	c0	7	c1	0	DBGWCR1	RW	<i>Debug Watchpoint Control Registers, EL1 on page 11-11</i>
0x828	c0	7	c2	0	DBGWCR2	RW	<i>Debug Watchpoint Control Registers, EL1 on page 11-11</i>
0x838	c0	7	c3	0	DBGWCR3	RW	<i>Debug Watchpoint Control Registers, EL1 on page 11-11</i>
-	c1	0	c0	0	DBGDRAR[31:0]	RO	Debug ROM Address Register
-	-	-	c1	-	DBGDRAR[63:0]	RO	
0x444	c1	1	c4	0	DBGBXVR4	RW	Debug Breakpoint Extended Value Register 4
0x454	c1	1	c5	0	DBGBXVR5	RW	Debug Breakpoint Extended Value Register 5
0x300	c1	4	c0	0	DBGOSLAR	WO	Debug OS Lock Access Register
-	c1	4	c1	0	DBGOSLSR	RO	Debug OS Lock Status Register
-	c1	4	c3	0	DBGOSDLR	RW	Debug OS Double Lock Register
0x310	c1	4	c4	0	DBGPRCR	RW	Debug Power/Reset Control Register
-	c2	2	c0	0	DBGDSAR[31:0] ^b	RO	Debug Self Address Register RES0
-	-	0	c2	-	DBGDSAR[63:0] ^b	RO	
-	c7	7	c0	0	DBGDEVID2	RO	Debug Device ID Register 2, RES0
-	c7	7	c1	0	DBGDEVID1	RO	<i>Debug Device ID Register 1 on page 11-19</i>
-	c7	7	c2	0	DBGDEVID	RO	<i>Debug Device ID Register on page 11-18</i>
0xFA0	c7	6	c8	0	DBGCLAIMSET	RW	Debug Claim Tag Set Register
0xFA4	c7	6	c9	0	DBGCLAIMCLR	RW	Debug Claim Tag Clear Register
0xFB8	c7	6	c14	0	DBGAUTHSTATUS	RO	Debug Authentication Status Register

a. Previously returned information about the address of the instruction that accessed a watchpoint address. This register is now deprecated and is RES0.

b. Previously defined the offset from the base address defined in DBGDRAR of the physical base address of the debug registers for the processor. This register is now deprecated and RES0.

11.6 AArch32 debug register descriptions

This section describes the debug registers in the AArch32 Execution state. The [AArch32 debug register summary on page 11-15](#) provides cross-references to the individual registers.

11.6.1 Debug ID Register

The DBGDIDR characteristics are:

- Purpose** Specifies:
- The version of the Debug architecture that is implemented.
 - Some features of the debug implementation.

Usage constraints This register is accessible as follows:

EL0 (NS)	EL0 (S)	EL1 (NS)	EL1 (S)	EL2	EL3 (SCR.NS = 1)	EL3 (SCR.NS = 0)
RO	RO	RO	RO	RO	RO	RO

Configurations There is one copy of this register that is used in both Secure and Non-secure states.

Attributes See the register summary in [Table 11-7 on page 11-15](#).

[Figure 11-5](#) shows the DBGDIDR bit assignments.

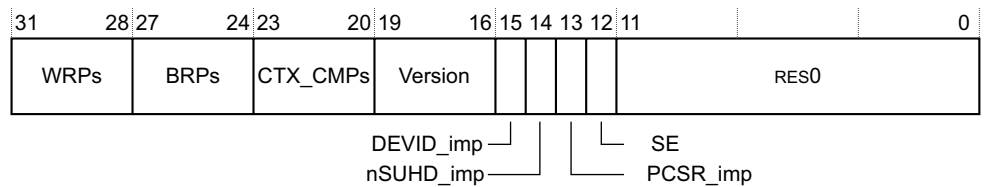

Figure 11-5 DBGDIDR bit assignments

[Table 11-8](#) shows the DBGDIDR bit assignments.

Table 11-8 DBGDIDR bit assignments

Bits	Name	Function
[31:28]	WRPs	The number of <i>Watchpoint Register Pairs</i> (WRPs) implemented. The number of implemented WRPs is one more than the value of this field. The value is: 0x3 The processor implements 4 WRPs. This field has the same value as ID_AA64DFR0_EL1.WRPs.
[27:24]	BRPs	The number of <i>Breakpoint Register Pairs</i> (BRPs) implemented. The number of implemented BRPs is one more than the value of this field. The value is: 0x5 The processor implements 6 BRPs. This field has the same value as ID_AA64DFR0_EL1.BRPs.
[23:20]	CTX_CMPs	The number of BRPs that can be used for Context matching. This is one more than the value of this field. The value is: 0x1 The processor implements two Context matching breakpoints, breakpoints 4 and 5. This field has the same value as ID_AA64DFR0_EL1.CTX_CMPs.

Table 11-8 DBGDIDR bit assignments (continued)

Bits	Name	Function
[19:16]	Version	The Debug architecture version. 0x6 The processor implements ARMv8 Debug architecture.
[15]	DEVID_imp	Reserved, RAO.
[14]	nSUHD_imp	Secure User Halting Debug not implemented bit. The value is: 1 The processor does not implement Secure User Halting Debug.
[13]	PCSR_imp	Reserved, RAZ.
[12]	SE	EL3 implemented. The value is: 1 The processor implements EL3.
[11:0]	-	Reserved, RES0.

To access the DBGDIDR in AArch32 Execution state, read the CP14 register with:

MRC p14, 0, <Rt>, c0, c0, 0; Read Debug ID Register

11.6.2 Debug Device ID Register

The DBGDEVID characteristics are:

Purpose Specifies the version of the Debug architecture is implemented, and some features of the debug implementation.

Usage constraints This register is accessible as follows:

EL0 (NS)	EL0 (S)	EL1 (NS)	EL1 (S)	EL2	EL3 (SCR.NS = 1)	EL3 (SCR.NS = 0)
-	-	RO	RO	RO	RO	RO

Configurations There is one copy of this register that is used in both Secure and Non-secure states.

Attributes See the register summary in [Table 11-7 on page 11-15](#).

[Figure 11-6](#) shows the DBGDEVID bit assignments.

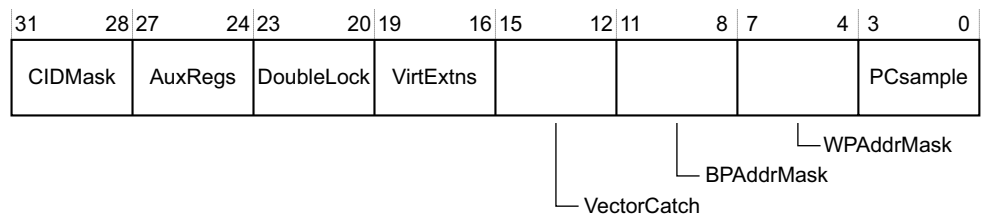

Figure 11-6 DBGDEVID bit assignments

Table 11-9 shows the DBGDEVID bit assignments.

Table 11-9 DBGDEVID bit assignments

Bits	Name	Function
[31:28]	CIDMask	Specifies the level of support for the Context ID matching breakpoint masking capability. This value is: 0x0 Context ID masking is not implemented.
[27:24]	AuxRegs	Specifies support for the Debug External Auxiliary Control Register. This value is: 0x0 None supported.
[23:20]	DoubleLock	Specifies support for the Debug OS Double Lock Register. This value is: 0x1 The processor supports Debug OS Double Lock Register.
[19:16]	VirExtns	Specifies whether EL2 is implemented. This value is: 0x1 The processor implements EL2.
[15:12]	VectorCatch	Defines the form of the vector catch event implemented. This value is: 0x0 The processor implements address matching form of vector catch.
[11:8]	BPAddrMask	Indicates the level of support for the <i>Immediate Virtual Address</i> (IVA) matching breakpoint masking capability. This value is: 0xF Breakpoint address masking not implemented. DBGBCRn[28:24] are res0.
[7:4]	WPAAddrMask	Indicates the level of support for the DVA matching watchpoint masking capability. This value is: 0x1 Watchpoint address mask implemented.
[3:0]	PCSample	Indicates the level of support for Program Counter sampling using debug registers 40 and 41. This value is: 0x3 EDPCSR, EDCIDSR and EDVIDSR are implemented as debug registers 40, 41, and 42.

To access the DBGDEVID in AArch32 Execution state, read the CP14 register with:

MRC p14, 0, <Rt>, c7, c2, 7; Read Debug Device ID Register 0

11.6.3 Debug Device ID Register 1

The DBGDEVID1 characteristics are:

Purpose Adds to the information given by the DBGDIDR by describing other features of the debug implementation.

Usage constraints This register is accessible as follows:

EL0 (NS)	EL0 (S)	EL1 (NS)	EL1 (S)	EL2	EL3 (SCR.NS = 1)	EL3 (SCR.NS = 0)
-	-	RO	RO	RO	RO	RO

Configurations There is one copy of this register that is used in both Secure and Non-secure states.

Attributes See the register summary in [Table 11-7 on page 11-15](#).

[Figure 11-7 on page 11-20](#) shows the DBGDEVID1 bit assignments.

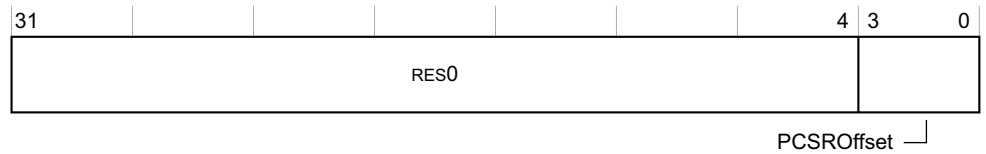

Figure 11-7 DBGDEVID1 bit assignments

Table 11-10 shows the DBGDEVID1 bit assignments.

Table 11-10 DBGDEVID1 bit assignments

Bits	Name	Function
[31:4]	-	Reserved, RES0.
[3:0]	-	Indicates the offset applied to PC samples returned by reads of EDPCSR. The value is: 0x2 EDPCSR samples have no offset applied and do not sample the instruction set state in the AArch32 state.

To access the DBGDEVID1 in AArch32 Execution state, read the CP14 register with:

MRC p14, 0, <Rt>, c7, c1, 47 Read Debug Device ID Register 1

11.7 Memory-mapped register summary

Table 11-11 shows the offset address for the registers that are accessible from the internal memory-mapped interface or the external debug interface. For those registers not described in this chapter, see the *ARM® Architecture Reference Manual ARMv8, for ARMv8-A architecture profile*.

Table 11-11 Memory-mapped debug register summary

Offset	Name	Type	Width	Description
0x000-0x01C	-	-	-	Reserved
0x020	EDES	RW	32	External Debug Event Status Register
0x024	EDECR	RW	32	External Debug Execution Control Register
0x028-0x02C	-	-	-	Reserved
0x030	EDWAR[31:0]	RO	64	External Debug Watchpoint Address Register
0x034	EDWAR[63:32]			
0x038-0x07C	-	-	-	Reserved
0x080	DBGDTRRX_EL0	RW	32	Debug Data Transfer Register, Receive
0x084	EDITR	WO	32	External Debug Instruction Transfer Register
0x088	EDSCR	RW	32	External Debug Status and Control Register
0x08C	DBGDTRTX_EL0	RW	32	Debug Data Transfer Register, Transmit
0x090	EDRCR	WO	32	External Debug Reserve Control Register
0x094	EDACR	RW	32	External Debug Auxiliary Control Register
0x098	EDECCR	RW	32	External Debug Exception Catch Control Register
0x09C	-	-	32	Reserved
0x0A0	EDPCSRlo	RO	32	External Debug Program Counter Sample Register, low word
0x0A4	EDCIDS	RO	32	External Debug Context ID Sample Register
0x0A8	EDVIDSR	RO	32	External Debug Virtual Context Sample Register
0x0AC	EDPCSRhi	RO	32	External Debug Program Counter Sample Register, high word
0x0B0-0x2FC	-	-	-	Reserved
0x300	OSLAR_EL1	WO	32	OS Lock Access Register
0x304-0x30C	-	-	-	Reserved
0x310	EDPRCR	RW	32	External Debug Power/Reset Control Register
0x314	EDPRSR	RO	32	External Debug Processor Status Register
0x318-0x3FC	-	-	--	Reserved
0x400	DBGBVR0_EL1[31:0]	RW	64	Debug Breakpoint Value Register 0
0x404	DBGBVR0_EL1[63:32]			
0x408	DBGBCR0_EL1	RW	32	<i>Debug Breakpoint Control Registers, EL1 on page 11-8</i>

Table 11-11 Memory-mapped debug register summary (continued)

Offset	Name	Type	Width	Description
0x40C	-	-	-	Reserved
0x410	DBGBVR1_EL1[31:0]	RW	64	Debug Breakpoint Value Register 1
0x414	DBGBVR1_EL1[63:32]			
0x418	DBGBCR1_EL1	RW	32	<i>Debug Breakpoint Control Registers, EL1 on page 11-8</i>
0x41C	-	-	-	Reserved
0x420	DBGBVR2_EL1[31:0]	RW	64	Debug Breakpoint Value Register 2
0x424	DBGBVR2_EL1[63:32]			
0x428	DBGBCR2_EL1	RW	32	<i>Debug Breakpoint Control Registers, EL1 on page 11-8</i>
0x42C	-	-	-	Reserved
0x430	DBGBVR3_EL1[31:0]	RW	64	Debug Breakpoint Value Register 3
0x434	DBGBVR3_EL1[63:32]			
0x438	DBGBCR3_EL1	RW	32	<i>Debug Breakpoint Control Registers, EL1 on page 11-8</i>
0x43C	-	-	-	Reserved
0x440	DBGBVR4_EL1[31:0]	RW	64	Debug Breakpoint Value Register 4
0x444	DBGBVR4_EL1[63:32]			
0x448	DBGBCR4_EL1	RW	32	<i>Debug Breakpoint Control Registers, EL1 on page 11-8</i>
0x44C	-	-	-	Reserved
0x450	DBGBVR5_EL1[31:0]	RW	64	Debug Breakpoint Value Register 5
0x454	DBGBVR5_EL1[63:32]			
0x458	DBGBCR5_EL1	RW	32	<i>Debug Breakpoint Control Registers, EL1 on page 11-8</i>
0x45C-0x7FC	-	-	-	Reserved
0x800	DBGWVR0_EL1[31:0]	RW	64	Debug Watchpoint Value Register 0
0x804	DBGWVR0_EL1[63:32]			
0x808	DBGWCR0_EL1	RW	32	<i>Debug Watchpoint Control Registers, EL1 on page 11-11</i>
0x80C	-	-	-	Reserved
0x810	DBGWVR1_EL1[31:0]	RW	64	Debug Watchpoint Value Register 1
0x814	DBGWVR1_EL1[63:32]			
0x818	DBGWCR1_EL1	RW	32	<i>Debug Watchpoint Control Registers, EL1 on page 11-11</i>
0x81C	-	-	-	Reserved
0x820	DBGWVR2_EL1[31:0]	RW	64	Debug Watchpoint Value Register 2
0x824	DBGWVR2_EL1[63:32]			
0x828	DBGWCR2_EL1	RW	32	<i>Debug Watchpoint Control Registers, EL1 on page 11-11</i>
0x82C	-	-	-	Reserved

Table 11-11 Memory-mapped debug register summary (continued)

Offset	Name	Type	Width	Description
0x830	DBGWVR3_EL1[31:0]	RW	64	Debug Watchpoint Value Register 0,
0x834	DBGWVR3_EL1[63:32]			
0x838	DBGWCR3_EL1	RW	32	<i>Debug Watchpoint Control Registers, EL1 on page 11-11</i>
0x83C–0xCFC	-	-	-	Reserved
0xD00	MIDR	RO	32	<i>Main ID Register, EL1 on page 4-14</i>
0xD04–0xD1C	-	-	-	Reserved
0xD20	ID_AA64PFR0_EL1[31:0]	RO	64	<i>AArch64 Processor Feature Register 0 on page 4-37</i>
0xD24	ID_AA64PFR0_EL1[63:32]			
0xD28	ID_AA64DFR0_EL1[31:0]	RO	64	<i>AArch64 Debug Feature Register 0, EL1 on page 4-39</i>
0xD2C	ID_AA64DFR0_EL1[63:32]			
0xD30	ID_AA64ISAR0_EL1[31:0]	RO	64	<i>AArch64 Instruction Set Attribute Register 0, EL1 on page 4-40</i>
0xD34	ID_AA64ISAR0_EL1[63:32]			
0xD38	ID_AA64MMFR0_EL1[31:0]	RO	64	<i>AArch64 Memory Model Feature Register 0, EL1 on page 4-41</i>
0xD3C	ID_AA64MMFR0_EL1[63:32]			
0xD40	ID_AA64PFR1_EL1[31:0]	RO	64	Processor Feature Register 1, RES0
0xD44	ID_AA64PFR1_EL1[63:32]			
0xD48	ID_AA64DFR1_EL1[31:0]	RO	64	Debug Feature Register 1, RES0
0xD4C	ID_AA64DFR1_EL1[63:32]			
0xD50	ID_AA64ISAR1_EL1[31:0]	RO	64	Instruction Set Attribute Register 1 low word, RES0
0xD54	ID_AA64ISAR1_EL1[63:32]			
0xD58	ID_AA64MMFR1_EL1[31:0]	RO	64	Memory Model Feature Register 1 low word, RES0
0xD5C	ID_AA64MMFR1_EL1[63:32]			
0xD60–0xEFC	-	-	-	Reserved
0xF00	EDITCTRL	RW	32	<i>External Debug Integration Mode Control Register on page 11-25</i>
0xF04–0xF9C	-	-	-	Reserved
0xFA0	DBGCLAIMSET_EL1	RW	32	<i>Debug Claim Tag Set register on page 11-13</i>
0xFA4	DBGCLAIMCLR_EL1	RW	32	Debug Claim Tag Clear Register
0xFA8	EDDEVAFF0	RO	32	<i>Multiprocessor Affinity Register on page 4-15</i>
0xFAC	EDDEVAFF1	RO	32	External Debug Device Affinity Register 1, RES0
0xFB0	EDLAR	WO	32	External Debug Lock Access Register
0xFB4	EDLSR	RO	32	External Debug Lock Status Register
0xFB8	DBGAUTHSTATUS_EL1	RO	32	Debug Authentication Status Register

Table 11-11 Memory-mapped debug register summary (continued)

Offset	Name	Type	Width	Description
0xFBC	EDDEVARCH	RO	32	External Debug Device Architecture Register
0xFC0	EDDEVID2	RO	32	External Debug Device ID Register 2, RES0
0xFC4	EDDEVID1	RO	32	<i>External Debug Device ID Register 1 on page 11-26</i>
0xFC8	EDDEVID	RO	32	<i>External Debug Device ID Register 0 on page 11-25</i>
0xFCC	EDDEVTYPE	RO	32	External Debug Device Type Register
0xFD0	EDPIDR4	RO	32	<i>Peripheral Identification Register 0 on page 11-28</i>
0xFD4-0xFDC	EDPIDR5-7	RO	32	<i>Peripheral Identification Register 5-7 on page 11-31</i>
0xFE0	EDPIDR0	RO	32	<i>Peripheral Identification Register 0 on page 11-28</i>
0xFE4	EDPIDR1	RO	32	<i>Peripheral Identification Register 1 on page 11-28</i>
0xFE8	EDPIDR2	RO	32	<i>Peripheral Identification Register 2 on page 11-29</i>
0xFEC	EDPIDR3	RO	32	<i>Peripheral Identification Register 3 on page 11-30</i>
0xFF0	EDCIDR0	RO	32	<i>Component Identification Register 0 on page 11-32</i>
0xFF4	EDCIDR1	RO	32	<i>Component Identification Register 1 on page 11-33</i>
0xFF8	EDCIDR2	RO	32	<i>Component Identification Register 2 on page 11-33</i>
0xFFC	EDCIDR3	RO	32	<i>Component Identification Register 3 on page 11-34</i>

11.8 Memory-mapped register descriptions

This section describes the Cortex-A53 processor debug registers. The [Memory-mapped debug register summary on page 11-21](#) provides cross-references to the individual registers.

11.8.1 External Debug Integration Mode Control Register

The EDITCTRL characteristics are:

Purpose Enables the external debug to switch from its default mode into integration mode, where test software can control directly the inputs and outputs of the processor, for integration testing or topology detection.

Usage constraints This register is accessible as follows:

Off	DLK	OSLK	EDAD	SLK	Default
-	-	-	-	RO	RW

[Table 11-1 on page 11-5](#) describes the condition codes.

Configurations EDITCTRL is in the processor power domain.

Attributes See the register summary in [Table 11-11 on page 11-21](#).

[Figure 11-8](#) shows the EDITCTRL bit assignments.

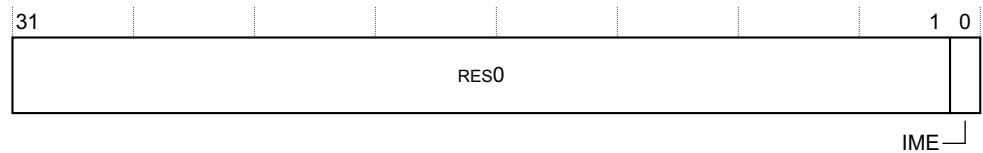

Figure 11-8 EDITCTRL bit assignments

[Table 11-12](#) shows the EDITCTRL bit assignments.

Table 11-12 EDITCTRL bit assignments

Bits	Name	Function
[31:1]	-	Reserved, RES0.
[0]	IME	Integration Mode Enable.
	RES0.	The device does not revert to an integration mode to enable integration testing or topology detection.

The EDITCTRL can be accessed through the internal memory-mapped interface and the external debug interface, offset 0xF00.

11.8.2 External Debug Device ID Register 0

The EDDEVID characteristics are:

Purpose Provides extra information for external debuggers about features of the debug implementation.

Usage constraints This register is accessible as follows:

Off	DLK	OSLK	EDAD	SLK	Default
-	-	-	-	-	RO

Table 11-1 on page 11-5 describes the condition codes.

Configurations The EDDEVID is in the Debug power domain.

Attributes See the register summary in Table 11-11 on page 11-21.

Figure 11-9 shows the EDDEVID bit assignments.

31	28	27	24	23	4	3	0
RES0	AuxRegs		RES0			PC Sample	

Figure 11-9 EDDEVID bit assignments

Table 11-13 shows the EDDEVID bit assignments.

Table 11-13 EDDEVID bit assignments

Bits	Name	Function
[31:28]	-	Reserved, RES0.
[27:24]	AuxRegs	Indicates support for Auxiliary registers: 0x0 None supported.
[23:4]	-	Reserved, RES0.
[3:0]	PC Sample	Indicates the level of sample-based profiling support using external debug registers 40 to 43: 0x3 EDPCSR, EDCIDSR and EDVIDSR are implemented.

The EDDEVID can be accessed through the internal memory-mapped interface and the external debug interface, offset 0xFC8.

11.8.3 External Debug Device ID Register 1

The EDDEVID1 characteristics are:

Purpose Provides extra information for external debuggers about features of the debug implementation.

Usage constraints This register is accessible as follows:

Off	DLK	OSLK	EDAD	SLK	Default
-	-	-	-	-	RO

Table 11-1 on page 11-5 describes the condition codes.

Configurations The EDDEVID1 is in the Debug power domain.

Attributes See the register summary in Table 11-11 on page 11-21.

Figure 11-10 on page 11-27 shows the EDDEVID1 bit assignments.

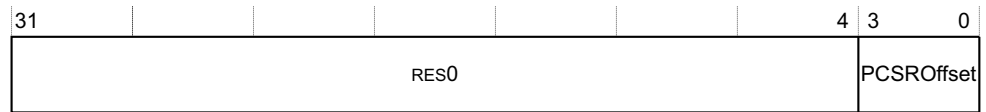

Figure 11-10 EDDEVID1 bit assignments

Table 11-14 shows the EDDEVID1 bit assignments.

Table 11-14 EDDEVID1 bit assignments

Bits	Name	Function
[31:4]	-	Reserved, RES0.
[3:0]	PCSROffset	Indicates the offset applied to PC samples returned by reads of EDPCSR: 0x2 EDPCSR samples have no offset applied and do not sample the instruction set state in AArch32 state.

The EDDEVID1 can be accessed through the internal memory-mapped interface and the external debug interface, offset 0xFC4.

11.8.4 Peripheral Identification Registers

The Peripheral Identification Registers provide standard information required for all components that conform to the ARM Debug Interface v5 specification. They are a set of eight registers, listed in register number order in Table 11-15.

Table 11-15 Summary of the Peripheral Identification Registers

Register	Value	Offset
Peripheral ID4	0x04	0xFD0
Peripheral ID5	0x00	0xFD4
Peripheral ID6	0x00	0xFD8
Peripheral ID7	0x00	0xFDC
Peripheral ID0	0x03	0xFE0
Peripheral ID1	0xBD	0xFE4
Peripheral ID2	0x2B	0xFE8
Peripheral ID3	0x00	0xFEC

Only bits[7:0] of each Peripheral ID Register are used, with bits[31:8] reserved. Together, the eight Peripheral ID Registers define a single 64-bit Peripheral ID.

The Debug Peripheral ID registers are:

- [Peripheral Identification Register 0](#) on page 11-28.
- [Peripheral Identification Register 1](#) on page 11-28.
- [Peripheral Identification Register 2](#) on page 11-29.
- [Peripheral Identification Register 3](#) on page 11-30.
- [Peripheral Identification Register 4](#) on page 11-31.
- [Peripheral Identification Register 5-7](#) on page 11-31.

Peripheral Identification Register 0

The EDPIDR0 characteristics are:

Purpose Provides information to identify an external debug component.

Usage constraints This register is accessible as follows:

Off	DLK	OSLK	EDAD	SLK	Default
-	-	-	-	-	RO

[Table 11-1 on page 11-5](#) describes the condition codes.

Configurations The EDPIDR0 is in the Debug power domain.

Attributes See the register summary in [Table 11-11 on page 11-21](#).

[Figure 11-11](#) shows the EDPIDR0 bit assignments.

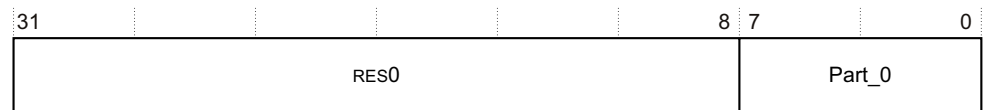

Figure 11-11 EDPIDR0 bit assignments

[Table 11-16](#) shows the EDPIDR0 bit assignments.

Table 11-16 EDPIDR0 bit assignments

Bits	Name	Function
[31:8]	-	Reserved, RES0.
[7:0]	Part_0	0x03 Least significant byte of the debug part number.

The EDPIDR0 can be accessed through the internal memory-mapped interface and the external debug interface, offset 0xFE0.

Peripheral Identification Register 1

The EDPIDR1 characteristics are:

Purpose Provides information to identify an external debug component.

Usage constraints This register is accessible as follows:

Off	DLK	OSLK	EDAD	SLK	Default
-	-	-	-	-	RO

[Table 11-1 on page 11-5](#) describes the condition codes.

Configurations The EDPIDR1 is in the Debug power domain.

Attributes See the register summary in [Table 11-11 on page 11-21](#).

[Figure 11-12 on page 11-29](#) shows the EDPIDR1 bit assignments.

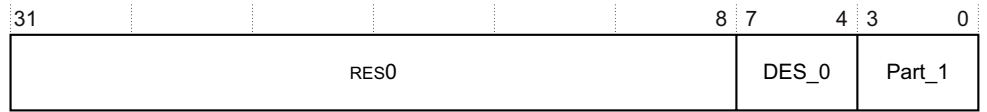

Figure 11-12 EDPIDR1 bit assignments

Table 11-17 shows the EDPIDR1 bit assignments.

Table 11-17 EDPIDR1 bit assignments

Bits	Name	Function
[31:8]	-	Reserved, RES0.
[7:4]	DES_0	0xB ARM Limited. This is the least significant nibble of JEP106 ID code.
[3:0]	Part_1	0xD Most significant nibble of the debug part number.

The EDPIDR1 can be accessed through the internal memory-mapped interface and the external debug interface, offset 0xFE4.

Peripheral Identification Register 2

The EDPIDR2 characteristics are:

Purpose Provides information to identify an external debug component.

Usage constraints This register is accessible as follows:

Off	DLK	OSLK	EDAD	SLK	Default
-	-	-	-	-	RO

Table 11-1 on page 11-5 describes the condition codes.

Configurations The EDPIDR2 is in the Debug power domain.

Attributes See the register summary in Table 11-11 on page 11-21.

Figure 11-13 shows the EDPIDR2 bit assignments.

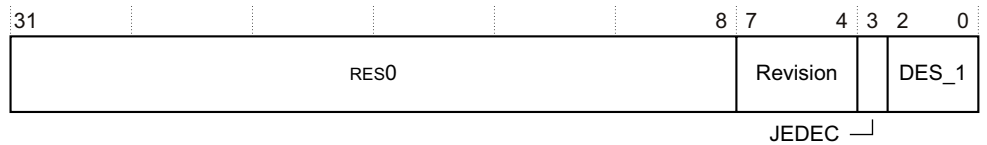

Figure 11-13 EDPIDR2 bit assignments

Table 11-18 shows the EDPIDR2 bit assignments.

Table 11-18 EDPIDR2 bit assignments

Bits	Name	Function
[31:8]	-	Reserved, RES0.
[7:4]	Revision	0x2 r0p2.
[3]	JEDEC	0b1 RAO. Indicates a JEP106 identity code is used.
[2:0]	DES_1	0b011 ARM Limited. This is the most significant nibble of JEP106 ID code.

The EDPIDR2 can be accessed through the internal memory-mapped interface and the external debug interface, offset 0xFE8.

Peripheral Identification Register 3

The EDPIDR3 characteristics are:

Purpose Provides information to identify an external debug component.

Usage constraints This register is accessible as follows:

Off	DLK	OSLK	EDAD	SLK	Default
-	-	-	-	-	RO

Table 11-1 on page 11-5 describes the condition codes.

Configurations The EDPIDR3 is in the Debug power domain.

Attributes See the register summary in Table 11-11 on page 11-21.

Figure 11-14 shows the EDPIDR3 bit assignments.

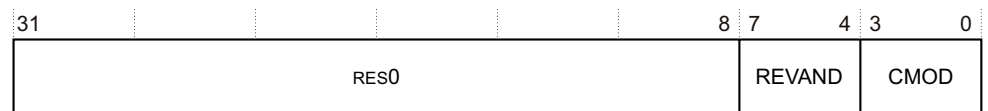

Figure 11-14 EDPIDR3 bit assignments

Table 11-19 shows the EDPIDR3 bit assignments.

Table 11-19 EDPIDR3 bit assignments

Bits	Name	Function
[31:8]	-	Reserved, RES0.
[7:4]	REVAND	0x0 Part minor revision.
[3:0]	CMOD	0x0 Customer modified.

The EDPIDR3 can be accessed through the internal memory-mapped interface and the external debug interface, offset 0xFEC.

Peripheral Identification Register 4

The EDPIDR4 characteristics are:

Purpose Provides information to identify an external debug component.

Usage constraints This register is accessible as follows:

Off	DLK	OSLK	EDAD	SLK	Default
-	-	-	-	-	RO

Table 11-1 on page 11-5 describes the condition codes.

Configurations The EDPIDR4 is in the Debug power domain.

Attributes See the register summary in Table 11-11 on page 11-21.

Figure 11-15 shows the EDPIDR4 bit assignments.

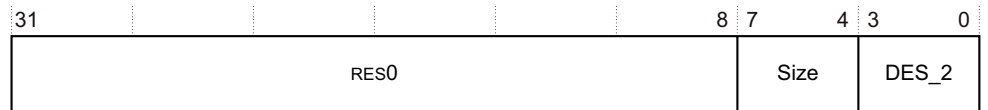

Figure 11-15 EDPIDR4 bit assignments

Table 11-20 shows the EDPIDR4 bit assignments.

Table 11-20 EDPIDR4 bit assignments

Bits	Name	Function
[31:8]	-	Reserved, RES0.
[7:4]	Size	0x0 Size of the component. Log2 the number of 4KB pages from the start of the component to the end of the component ID registers.
[3:0]	DES_2	0x4 ARM Limited. This is the least significant nibble JEP106 continuation code.

The EDPIDR4 can be accessed through the internal memory-mapped interface and the external debug interface, offset 0xFD0.

Peripheral Identification Register 5-7

No information is held in the Peripheral ID5, Peripheral ID6 and Peripheral ID7 Registers. They are reserved for future use and are RES0.

11.8.5 Component Identification Registers

There are four read-only Component Identification Registers, Component ID0 through Component ID3. [Table 11-21](#) shows these registers.

Table 11-21 Summary of the Component Identification Registers

Register	Value	Offset
Component ID0	0x00	0xFF0
Component ID1	0x90	0xFF4
Component ID2	0x05	0xFF8
Component ID3	0xB1	0xFFC

The Component Identification Registers identify Debug as an ARM Debug Interface v5 component. The Component ID registers are:

- [Component Identification Register 0](#).
- [Component Identification Register 1](#) on page 11-33.
- [Component Identification Register 2](#) on page 11-33.
- [Component Identification Register 3](#) on page 11-34.

Component Identification Register 0

The EDCIDR0 characteristics are:

Purpose Provides information to identify an external debug component.

Usage constraints This register is accessible as follows:

Off	DLK	OSLK	EDAD	SLK	Default
-	-	-	-	-	RO

[Table 11-1](#) on page 11-5 describes the condition codes.

Configurations The EDCIDR0 is in the Debug power domain.

Attributes See the register summary in [Table 11-11](#) on page 11-21.

[Figure 11-16](#) shows the EDCIDR0 bit assignments.

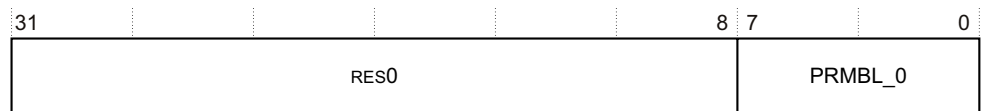

Figure 11-16 EDCIDR0 bit assignments

Table 11-22 shows the EDCIDR0 bit assignments.

Table 11-22 EDCIDR0 bit assignments

Bits	Name	Function
[31:8]	-	Reserved, RES0.
[7:0]	Size	0x0D Preamble byte 0.

The EDCIDR0 can be accessed through the internal memory-mapped interface and the external debug interface, offset 0xFF0.

Component Identification Register 1

The EDCIDR1 characteristics are:

Purpose Provides information to identify an external debug component.

Usage constraints This register is accessible as follows:

Off	DLK	OSLK	EDAD	SLK	Default
-	-	-	-	-	RO

Table 11-1 on page 11-5 describes the condition codes.

Configurations The EDCIDR1 is in the Debug power domain.

Attributes See the register summary in Table 11-11 on page 11-21.

Figure 11-17 shows the EDCIDR1 bit assignments.

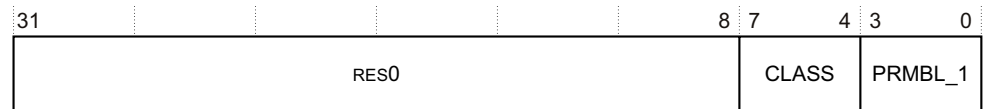

Figure 11-17 EDCIDR1 bit assignments

Table 11-23 shows the EDCIDR1 bit assignments.

Table 11-23 EDCIDR1 bit assignments

Bits	Name	Function
[31:8]	-	Reserved, RES0.
[7:4]	CLASS	0x9 Debug component.
[3:0]	PRMBL_1	0x0 Preamble.

The EDCIDR1 can be accessed through the internal memory-mapped interface and the external debug interface, offset 0xFF4.

Component Identification Register 2

The EDCIDR2 characteristics are:

Purpose Provides information to identify an external debug component.

Usage constraints This register is accessible as follows:

Off	DLK	OSLK	EDAD	SLK	Default
-	-	-	-	-	RO

[Table 11-1 on page 11-5](#) describes the condition codes.

Configurations The EDCIDR2 is in the Debug power domain.

Attributes See the register summary in [Table 11-11 on page 11-21](#).

[Figure 11-18](#) shows the EDCIDR2 bit assignments.

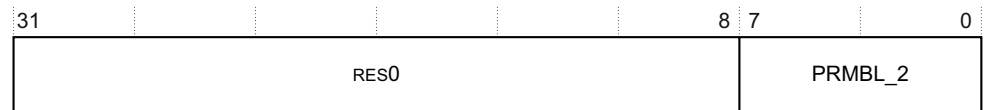

Figure 11-18 EDCIDR2 bit assignments

[Table 11-24](#) shows the EDCIDR2 bit assignments.

Table 11-24 EDCIDR2 bit assignments

Bits	Name	Function
[31:8]	-	Reserved, RES0.
[7:0]	PRMBL_2	0x05 Preamble byte 2.

The EDCIDR2 can be accessed through the internal memory-mapped interface and the external debug interface, offset 0xFF8.

Component Identification Register 3

The EDCIDR3 characteristics are:

Purpose Provides information to identify an external debug component.

Usage constraints This register is accessible as follows:

Off	DLK	OSLK	EDAD	SLK	Default
-	-	-	-	-	RO

[Table 11-1 on page 11-5](#) describes the condition codes.

Configurations The EDCIDR3 is in the Debug power domain.

Attributes See the register summary in [Table 11-11 on page 11-21](#).

[Figure 11-19 on page 11-35](#) shows the EDCIDR3 bit assignments.

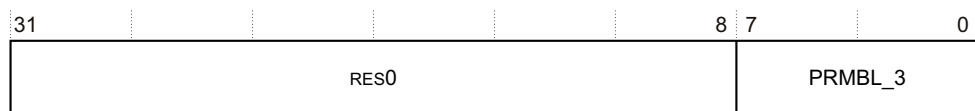

Figure 11-19 EDCIDR3 bit assignments

Table 11-25 shows the EDCIDR3 bit assignments.

Table 11-25 EDCIDR3 bit assignments

Bits	Name	Function
[31:8]	-	Reserved, RES0.
[7:0]	PRMBL_3	0x81 Preamble byte 3.

The EDCIDR3 can be accessed through the internal memory-mapped interface and the external debug interface, offset 0xFFC.

11.9 Debug events

A debug event can be either:

- A software debug event.
- A halting debug event.

A core responds to a debug event in one of the following ways:

- Ignores the debug event.
- Takes a debug exception.
- Enters debug state.

This section describes debug events in:

- [Watchpoint debug events](#).
- [Debug OS Lock](#).

See the *ARM® Architecture Reference Manual ARMv8, for ARMv8-A architecture profile* for more information on debug events.

11.9.1 Watchpoint debug events

In the Cortex-A53 processor, watchpoint debug events are always synchronous. Memory hint instructions and cache clean operations, except DC ZVA, DC IVAC, and DCIMVAC, do not generate watchpoint debug events. Store exclusive instructions generate a watchpoint debug event even when the check for the control of exclusive monitor fails.

For watchpoint debug events, except those resulting from cache maintenance operations, the value reported in DFAR is guaranteed to be no lower than the address of the watchpointed location rounded down to a multiple of 16 bytes.

11.9.2 Debug OS Lock

Debug OS Lock is set by the powerup reset, **nCPUPORESET**, see [Resets on page 2-14](#). For normal behavior of debug events and debug register accesses, Debug OS Lock must be cleared. For more information, see the *ARM® Architecture Reference Manual ARMv8, for ARMv8-A architecture profile*.

11.10 External debug interface

The system can access memory-mapped debug registers through the APB interface. The APB interface is compliant with the AMBA 4 APB interface.

Figure 11-20 shows the debug interface implemented in the Cortex-A53 processor. For more information on these signals, see the *ARM® CoreSight™ Architecture Specification*.

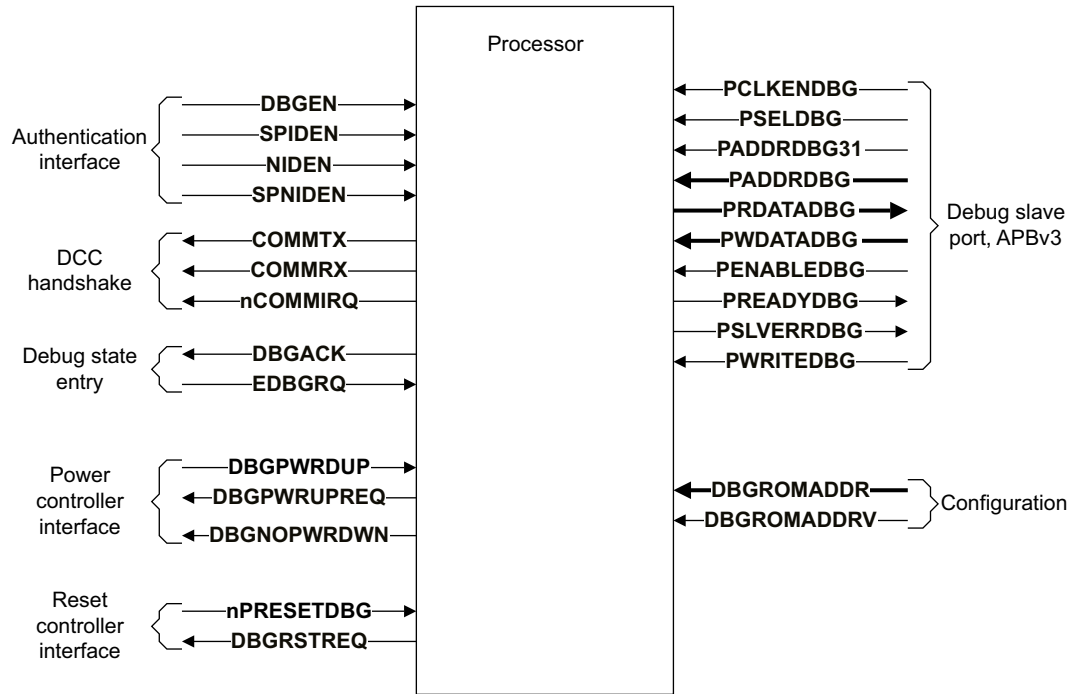

Figure 11-20 External debug interface, including APBv3 slave port

This section describes external debug interface in:

- [Debug memory map.](#)
- [DBGPWRDUP debug signal on page 11-39.](#)
- [DBGLIRSTDISABLE debug signal on page 11-39.](#)
- [Changing the authentication signals on page 11-40.](#)

11.10.1 Debug memory map

The basic memory map supports up to four cores in the cluster. Table 11-26 shows the address mapping for the Cortex-A53 processor debug APB components when configured for v8 Debug memory map.

Each component in the table requires 4KB, and uses the bottom 4KB of each 64KB region. The remaining 60KB of each region is reserved.

Table 11-26 Address mapping for APB components

Address offset [21:0]	Component ^a
0x000000 - 0x000FFF	Cortex-A53 APB ROM table
0x010000 - 0x010FFF	CPU 0 Debug
0x020000 - 0x020FFF	CPU 0 CTI

Table 11-26 Address mapping for APB components (continued)

Address offset [21:0]	Component ^a
0x030000 - 0x030FFF	CPU 0 PMU
0x040000 - 0x040FFF	CPU 0 Trace
0x041000 - 0x10FFFF	Reserved
0x110000 - 0x110FFF	CPU 1 Debug
0x120000 - 0x120FFF	CPU 1 CTI
0x130000 - 0x130FFF	CPU 1 PMU
0x140000 - 0x140FFF	CPU 1 Trace
0x141000 - 0x20FFFF	Reserved
0x210000 - 0x210FFF	CPU 2 Debug
0x220000 - 0x220FFF	CPU 2 CTI
0x230000 - 0x230FFF	CPU 2 PMU
0x240000 - 0x240FFF	CPU 2 Trace
0x241000 - 0x30FFFF	Reserved
0x310000 - 0x310FFF	CPU 3 Debug
0x320000 - 0x320FFF	CPU 3 CTI
0x330000 - 0x330FFF	CPU 3 PMU
0x340000 - 0x340FFF	CPU 3 Trace
0x341000 - 0x3FFFFF	Reserved

a. Indicates the mapped component if present, otherwise reserved.

Table 11-27 shows the address mapping for the Cortex-A53 processor debug APB components when configured for v7 Debug memory map.

Table 11-27 Address mapping for APB components

Address offset [21:0]	Component ^a
0x00000 - 0x00FFF	Cortex-A53 APB ROM table
0x01000 - 0x07FFF	Reserved for other debug components
0x08000 - 0x0FFFF	Reserved for future expansion
0x01000 - 0x10FFF	CPU 0 Debug
0x11000 - 0x11FFF	CPU 0 PMU
0x12000 - 0x12FFF	CPU 1 Debug
0x13000 - 0x13FFF	CPU 1 PMU
0x14000 - 0x14FFF	CPU 2 Debug
0x15000 - 0x15FFF	CPU 2 PMU

Table 11-27 Address mapping for APB components (continued)

Address offset [21:0]	Component ^a
0x16000 - 0x16FFF	CPU 3 Debug
0x17000 - 0x17FFF	CPU 3 PMU
0x18000 - 0x18FFF	CPU 0 CTI
0x19000 - 0x19FFF	CPU 1 CTI
0x1A000 - 0x1AFFF	CPU 2 CTI
0x1B000 - 0x1BFFF	CPU 3 CTI
0x1C000 - 0x1CFFF	CPU 0 Trace
0x1D000 - 0x1DFFF	CPU 1 Trace
0x1E000 - 0x1EFFF	CPU 2 Trace
0x1F000 - 0x1FFFF	CPU 3 Trace

a. Indicates the mapped component if present, otherwise reserved.

11.10.2 DBGPWDUP debug signal

You must set the **DBGPWDUP** signal LOW before removing power to the processor domain. After power is restored to the processor domain, the **DBGPWDUP** signal must be asserted HIGH. The EDPRSR.PU bit reflects the value of this **DBGPWDUP** signal.

———— **Note** —————

DBGPWDUP must be tied HIGH if the particular implementation does not support separate processor and SCU power domains.

11.10.3 DBGL1RSTDISABLE debug signal

When set HIGH, the **DBGL1RSTDISABLE** input signal disables the automatic hardware controlled invalidation of the L1 data cache after the processor is reset, using **nCORERESET** or **nCPUPORESET**.

The **DBGL1RSTDISABLE** must be used only to assist debug of an external watchdog triggered reset by allowing the contents of the L1 data cache prior to the reset to be observable after the reset. If reset is asserted, while an L1 data cache eviction or L1 data cache fetch is performed, the accuracy of those cache entries is not guaranteed.

You must not use the **DBGL1RSTDISABLE** signal to disable automatic hardware controlled invalidation of the L1 data cache in normal processor powerup sequences. This is because synchronisation of the L1 data cache invalidation sequence with the duplicate L1 tags in the SCU is not guaranteed.

The **DBGL1RSTDISABLE** signal applies to all cores in the cluster. Each core samples the signal when **nCORERESET** or **nCPUPORESET** is asserted.

If the functionality offered by the **DBGL1RSTDISABLE** input signal is not required, the input must be tied to LOW.

11.10.4 Changing the authentication signals

The **NIDEN**, **DBGEN**, **SPIDEN**, and **SPNIDEN** input signals are either tied off to some fixed value or controlled by some external device.

If software running on the processor has control over an external device that drives the authentication signals, it must make the change using a safe sequence:

1. Execute an implementation-specific sequence of instructions to change the signal value. For example, this might be a single STR instruction that writes certain value to a control register in a system peripheral.
2. If step 1 involves any memory operation, issue a DSB instruction.
3. Issue an ISB instruction or exception entry or exception return.
4. Poll the DBGAUTHSTATUS_EL1 to check whether the processor has already detected the changed value of these signals. This is required because the system might not issue the signal change to the processor until several cycles after the DSB instruction completes.

The software cannot perform debug or analysis operations that depend on the new value of the authentication signals until this procedure is complete. The same rules apply when the debugger has control of the processor through the Instruction Transfer Register, EDITR, while in debug state. The relevant combinations of the **DBGEN**, **NIDEN**, **SPIDEN**, and **SPNIDEN** values can be determined by polling DBGAUTHSTATUS_EL1.

11.11 ROM table

The Cortex-A53 processor includes a ROM table that complies with the *ARM® CoreSight™ Architecture Specification*. This table contains a list of components such as processor debug units, processor *Cross Trigger Interfaces* (CTIs), processor *Performance Monitoring Units* (PMUs) and processor *Embedded Trace Macrocell* (ETM) trace units. Debuggers can use the ROM table to determine which components are implemented inside the Cortex-A53 processor.

If a component is not included in your configuration of the Cortex-A53 processor, the corresponding debug APB ROM table entry is still present but the component is marked as not present.

11.11.1 ROM table register interface

The interface to the ROM table entries is the APB slave port. See [External debug interface on page 11-37](#).

11.11.2 ROM table register summary

[Table 11-28](#) shows the offsets from the physical base address of the ROM table.

Table 11-28 ROM table registers

Offset	Name	Type	Description
0x000	ROMENTRY0	RO	Core 0 Debug, see ROM entry registers on page 11-42
0x004	ROMENTRY1	RO	Core 0 CTI, see ROM entry registers on page 11-42
0x008	ROMENTRY2	RO	Core 0 PMU, see ROM entry registers on page 11-42
0x00C	ROMENTRY3	RO	Core 0 ETM, see ROM entry registers on page 11-42
0x010	ROMENTRY4	RO	Core 1 Debug, see ROM entry registers on page 11-42
0x014	ROMENTRY5	RO	Core 1 CTI, see ROM entry registers on page 11-42
0x018	ROMENTRY6	RO	Core 1 PMU, see ROM entry registers on page 11-42
0x01C	ROMENTRY7	RO	Core 1 ETM, see ROM entry registers on page 11-42
0x020	ROMENTRY8	RO	Core 2 Debug, see ROM entry registers on page 11-42
0x024	ROMENTRY9	RO	Core 2 CTI, see ROM entry registers on page 11-42
0x028	ROMENTRY10	RO	Core 2 PMU, see ROM entry registers on page 11-42
0x02C	ROMENTRY11	RO	Core 2 ETM, see ROM entry registers on page 11-42
0x030	ROMENTRY12	RO	Core 3 Debug, see ROM entry registers on page 11-42
0x034	ROMENTRY13	RO	Core 3 CTI, see ROM entry registers on page 11-42
0x038	ROMENTRY14	RO	Core 3 PMU, see ROM entry registers on page 11-42
0x03C	ROMENTRY15	RO	Core 3 ETM, see ROM entry registers on page 11-42
0x040–0xFCC	-	RO	Reserved, RES0
0xFD0	ROMPIDR4	RO	Peripheral Identification Register 4 on page 11-48
0xFD4	ROMPIDR5	RO	Peripheral Identification Register 5-7 on page 11-49
0xFD8	ROMPIDR6	RO	Peripheral Identification Register 5-7 on page 11-49

Table 11-28 ROM table registers (continued)

Offset	Name	Type	Description
0xFDC	ROMPIDR7	RO	<i>Peripheral Identification Register 5-7 on page 11-49</i>
0xFE0	ROMPIDR0	RO	<i>Peripheral Identification Register 0 on page 11-45</i>
0xFE4	ROMPIDR1	RO	<i>Peripheral Identification Register 1 on page 11-46</i>
0xFE8	ROMPIDR2	RO	<i>Peripheral Identification Register 2 on page 11-47</i>
0xFEC	ROMPIDR3	RO	<i>Peripheral Identification Register 3 on page 11-47</i>
0xFF0	ROMCIDR0	RO	<i>Component Identification Register 0 on page 11-49</i>
0xFF4	ROMCIDR1	RO	<i>Component Identification Register 1 on page 11-50</i>
0xFF8	ROMCIDR2	RO	<i>Component Identification Register 2 on page 11-51</i>
0xFFC	ROMCIDR3	RO	<i>Component Identification Register 3 on page 11-51</i>

11.11.3 ROM table register descriptions

This section describes the ROM table registers. [Table 11-28 on page 11-41](#) provides cross-references to individual registers.

ROM entry registers

The characteristics of the ROMENTRY n are:

Purpose Indicates to a debugger whether the debug component is present in the processor's debug logic. There are 16 ROMENTRY registers in the Cortex-A53 processor.

Usage constraints These registers are accessible as follows:

Off	DLK	OSLK	EDAD	SLK	Default
-	-	-	-	-	RO

[Table 11-1 on page 11-5](#) describes the condition codes.

Configurations There is one copy of this register that is used in both Secure and Non-secure states.

Attributes See the register summary in [Table 11-28 on page 11-41](#).

[Figure 11-21](#) shows the bit assignments for a ROMENTRY register.

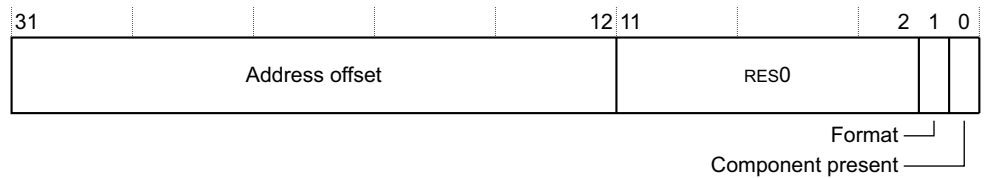

Figure 11-21 ROMENTRY bit assignments

Table 11-29 shows the bit assignments for a ROMENTRY register.

Table 11-29 ROMENTRY bit assignments

Bits	Name	Function
[31:12]	Address offset	Address offset for the debug component. ———— Note ———— Negative values of address offsets are permitted using the two's complement of the offset.
[11:2]	-	Reserved, RES0.
[1]	Format	Format of the ROM table entry. The value for all ROMENTRY registers is: 0 End marker. 1 32-bit format.
[0]	Component present ^a	Indicates whether the component is present: 0 Component is not present. 1 Component is present.

a. The components for core 0 are always present. The entries for core 1, 2, and 3 components depend on your configuration.

The Physical Address of a debug component is determined by shifting the address offset 12 places to the left and adding the result to the Physical Address of the Cortex-A53 processor ROM Table.

Table 11-30 shows the offset values for all ROMENTRY values when a v8 memory map is implemented. Table 11-31 on page 11-44 shows the offset values for all ROMENTRY values when a legacy v7 memory map is implemented.

If a core is not implemented, the ROMENTRY registers for its debug, CTI, PMU and ETM trace unit components are 0x00000000 when a v8 memory map is implemented and 0x00000002 when a v7 memory map is implemented.

Table 11-30 v8 ROMENTRY values

Name	Debug component	Offset value	ROMENTRY value
ROMENTRY0	Core 0 Debug	0x00010	0x00010003
ROMENTRY1	Core 0 CTI	0x00020	0x00020003
ROMENTRY2	Core 0 PMU	0x00030	0x00030003
ROMENTRY3	Core 0 ETM trace unit	0x00040	0x00040003
ROMENTRY4	Core 1 Debug	0x00110	0x00110003 ^a
ROMENTRY5	Core 1 CTI	0x00120	0x00120003 ^a
ROMENTRY6	Core 1 PMU	0x00130	0x00130003 ^a
ROMENTRY7	Core 1 ETM trace unit	0x00140	0x00140003 ^a
ROMENTRY8	Core 2 Debug	0x00210	0x00210003 ^a
ROMENTRY9	Core 2 CTI	0x00220	0x00220003 ^a
ROMENTRY10	Core 2 PMU	0x00230	0x00230003 ^a
ROMENTRY11	Core 2 ETM trace unit	0x00240	0x00240003 ^a

Table 11-30 v8 ROMENTRY values (continued)

Name	Debug component	Offset value	ROMENTRY value
ROMENTRY12	Core 3 Debug	0x00310	0x00310003 ^a
ROMENTRY13	Core 3 CTI	0x00320	0x00320003 ^a
ROMENTRY14	Core 3 PMU	0x00330	0x00330003 ^a
ROMENTRY15	Core 3 ETM trace unit	0x00340	0x00340003 ^a

a. If the component is present.

Table 11-31 Legacy v7 ROMENTRY values

Name	Debug component	Offset value	ROMENTRY value
ROMENTRY0	Core 0 Debug	0x00010	0x00010003
ROMENTRY1	Core 0 CTI	0x00018	0x00018003
ROMENTRY2	Core 0 PMU	0x00011	0x00011003
ROMENTRY3	Core 0 ETM trace unit	0x0001C	0x0001C003
ROMENTRY4	Core 1 Debug	0x00012	0x00012003 ^a
ROMENTRY5	Core 1 CTI	0x00019	0x00019003 ^a
ROMENTRY6	Core 1 PMU	0x00013	0x00013003 ^a
ROMENTRY7	Core 1 ETM trace unit	0x0001D	0x0001D003 ^a
ROMENTRY8	Core 2 Debug	0x00014	0x00014003 ^a
ROMENTRY9	Core 2 CTI	0x0001A	0x0001A003 ^a
ROMENTRY10	Core 2 PMU	0x00015	0x00015003 ^a
ROMENTRY11	Core 2 ETM trace unit	0x0001E	0x0001E003 ^a
ROMENTRY12	Core 3 Debug	0x00016	0x00016003 ^a
ROMENTRY13	Core 3 CTI	0x0001B	0x0001B003 ^a
ROMENTRY14	Core 3 PMU	0x00017	0x00017003 ^a
ROMENTRY15	Core 3 ETM trace unit	0x0001F	0x0001F003 ^a

a. If the component is present.

11.11.4 Peripheral Identification Registers

The Peripheral Identification Registers provide standard information required for all components that conform to the ARM Debug Interface v5 specification. There is a set of eight registers, listed in register number order in [Table 11-32](#).

Table 11-32 Summary of the ROM table Peripheral Identification Registers

Register	Value	Offset
ROMPIDR4	0x04	0xFD0
ROMPIDR5	0x00	0xFD4
ROMPIDR6	0x00	0xFD8
ROMPIDR7	0x00	0xFDC
ROMPIDR0	0xA1	0xFE0
ROMPIDR1	0xB4	0xFE4
ROMPIDR2	0x2B	0xFE8
ROMPIDR3	0x00	0xFEC

Only bits[7:0] of each Peripheral ID Register are used, with bits[31:8] reserved. Together, the eight Peripheral ID Registers define a single 64-bit Peripheral ID.

The ROM table Peripheral ID registers are:

- [Peripheral Identification Register 0](#).
- [Peripheral Identification Register 1](#) on page 11-46.
- [Peripheral Identification Register 2](#) on page 11-47.
- [Peripheral Identification Register 3](#) on page 11-47.
- [Peripheral Identification Register 4](#) on page 11-48.
- [Peripheral Identification Register 5-7](#) on page 11-49.

Peripheral Identification Register 0

The ROMPIDR0 characteristics are:

Purpose Provides information to identify an external debug component.

Usage constraints This register is accessible as follows:

Off	DLK	OSLK	EDAD	SLK	Default
-	-	-	-	-	RO

[Table 11-1](#) on page 11-5 describes the condition codes.

Configurations The ROMPIDR0 is in the Debug power domain.

Attributes See the register summary in [Table 11-28](#) on page 11-41.

[Figure 11-22](#) on page 11-46 shows the ROMPIDR0 bit assignments.

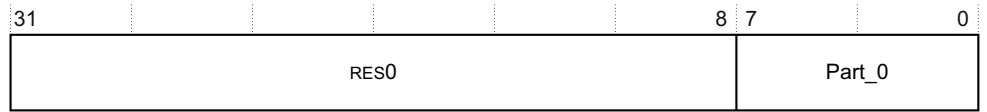

Figure 11-22 ROMPIDR0 bit assignments

Table 11-33 shows the ROMPIDR0 bit assignments.

Table 11-33 ROMPIDR0 bit assignments

Bits	Name	Function
[31:8]	-	Reserved, RES0.
[7:0]	Part_0	Least significant byte of the ROM table part number. 0xA1 for v8 memory map. 0xA3 for v7 memory map.

The ROMPIDR0 can be accessed through the internal memory-mapped interface and the external debug interface, offset 0xFE0.

Peripheral Identification Register 1

The ROMPIDR1 characteristics are:

Purpose Provides information to identify an external debug component.

Usage constraints This register is accessible as follows:

Off	DLK	OSLK	EDAD	SLK	Default
-	-	-	-	-	RO

Table 11-1 on page 11-5 describes the condition codes.

Configurations The ROMPIDR1 is in the Debug power domain.

Attributes See the register summary in Table 11-28 on page 11-41.

Figure 11-23 shows the ROMPIDR1 bit assignments.

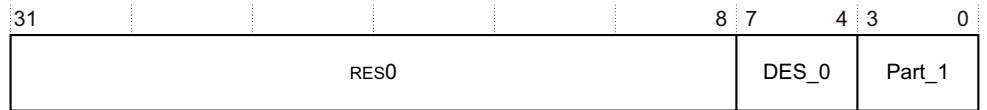

Figure 11-23 ROMPIDR1 bit assignments

Table 11-34 shows the ROMPIDR1 bit assignments.

Table 11-34 ROMPIDR1 bit assignments

Bits	Name	Function
[31:8]	-	Reserved, RES0.
[7:4]	DES_0	0xB Least significant nibble of JEP106 ID code. For ARM Limited.
[3:0]	Part_1	0x4 Most significant nibble of the ROM table part number.

The ROMPIDR1 can be accessed through the internal memory-mapped interface and the external debug interface, offset 0xFE4.

Peripheral Identification Register 2

The ROMPIDR2 characteristics are:

Purpose Provides information to identify an external debug component.

Usage constraints This register is accessible as follows:

Off	DLK	OSLK	EDAD	SLK	Default
-	-	-	-	-	RO

Table 11-1 on page 11-5 describes the condition codes.

Configurations The ROMPIDR2 is in the Debug power domain.

Attributes See the register summary in Table 11-28 on page 11-41.

Figure 11-24 shows the ROMPIDR2 bit assignments.

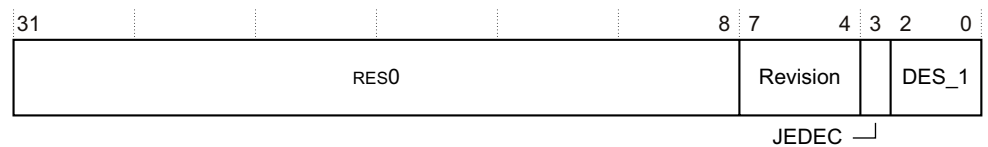

Figure 11-24 ROMPIDR2 bit assignments

Table 11-35 shows the ROMPIDR2 bit assignments.

Table 11-35 ROMPIDR2 bit assignments

Bits	Name	Function
[31:8]	-	Reserved, RES0.
[7:4]	Revision	0x2 r0p2.
[3]	JEDEC	0b1 RAO. Indicates a JEP106 identity code is used.
[2:0]	DES_1	0b011 Designer, most significant bits of JEP106 ID code. For ARM Limited.

The ROMPIDR2 can be accessed through the internal memory-mapped interface and the external debug interface, offset 0xFE8.

Peripheral Identification Register 3

The ROMPIDR3 characteristics are:

Purpose Provides information to identify an external debug component.

Usage constraints This register is accessible as follows:

Off	DLK	OSLK	EDAD	SLK	Default
-	-	-	-	-	RO

[Table 11-1 on page 11-5](#) describes the condition codes.

Configurations The ROMPIDR3 is in the Debug power domain.

Attributes See the register summary in [Table 11-28 on page 11-41](#).

[Figure 11-25](#) shows the ROMPIDR3 bit assignments.

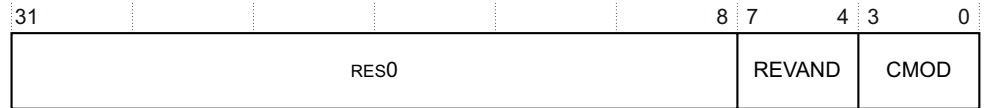

Figure 11-25 ROMPIDR3 bit assignments

[Table 11-36](#) shows the ROMPIDR3 bit assignments.

Table 11-36 ROMPIDR3 bit assignments

Bits	Name	Function
[31:8]	-	Reserved, RES0.
[7:4]	REVAND	0x0 Part minor revision.
[3:0]	CMOD	0x0 Customer modified.

The ROMPIDR3 can be accessed through the internal memory-mapped interface and the external debug interface, offset 0xFEC.

Peripheral Identification Register 4

The ROMPIDR4 characteristics are:

Purpose Provides information to identify an external debug component.

Usage constraints This register is accessible as follows:

Off	DLK	OSLK	EDAD	SLK	Default
-	-	-	-	-	RO

[Table 11-1 on page 11-5](#) describes the condition codes.

Configurations The ROMPIDR4 is in the Debug power domain.

Attributes See the register summary in [Table 11-28 on page 11-41](#).

[Figure 11-26](#) shows the ROMPIDR4 bit assignments.

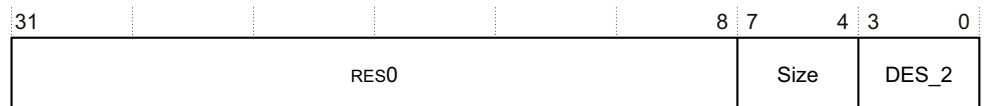

Figure 11-26 ROMPIDR4 bit assignments

Table 11-37 shows the ROMPIDR4 bit assignments.

Table 11-37 ROMPIDR4 bit assignments

Bits	Name	Function
[31:8]	-	Reserved, RES0.
[7:4]	Size	0x0 Size of the component. Log2 the number of 4KB pages from the start of the component to the end of the component ID registers.
[3:0]	DES_2	0x4 Designer, JEP106 continuation code, least significant nibble. For ARM Limited.

The ROMPIDR4 can be accessed through the internal memory-mapped interface and the external debug interface, offset 0xFD0.

Peripheral Identification Register 5-7

No information is held in the Peripheral ID5, Peripheral ID6 and Peripheral ID7 Registers. They are reserved for future use and are RES0.

11.11.5 Component Identification Registers

There are four read-only Component Identification Registers, Component ID0 through Component ID3. Table 11-38 shows these registers.

Table 11-38 Summary of the ROM table component Identification registers

Register	Value	Offset
ROMCIDR0	0x0D	0xFF0
ROMCIDR1	0x10	0xFF4
ROMCIDR2	0x05	0xFF8
ROMCIDR3	0xB1	0xFFC

The Component Identification Registers identify Debug as an ARM Debug Interface v5 component. The ROM table Component ID registers are:

- [Component Identification Register 0](#).
- [Component Identification Register 1 on page 11-50](#).
- [Component Identification Register 2 on page 11-51](#).
- [Component Identification Register 3 on page 11-51](#).

Component Identification Register 0

The ROMCIDR0 characteristics are:

Purpose Provides information to identify an external debug component.

Usage constraints This register is accessible as follows:

Off	DLK	OSLK	EDAD	SLK	Default
-	-	-	-	-	RO

Table 11-1 on page 11-5 describes the condition codes.

Configurations The ROMCIDR0 is in the Debug power domain.

Attributes See the register summary in [Table 11-28 on page 11-41](#).

[Figure 11-27](#) shows the ROMCIDR0 bit assignments.

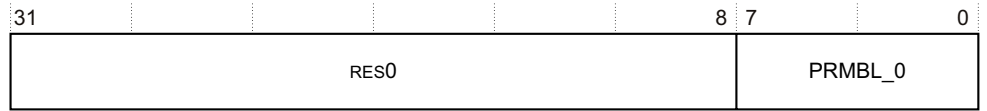

Figure 11-27 ROMCIDR0 bit assignments

[Table 11-39](#) shows the ROMCIDR0 bit assignments.

Table 11-39 ROMCIDR0 bit assignments

Bits	Name	Function
[31:8]	-	Reserved, RES0.
[7:0]	Size	0x0D Preamble byte 0.

The ROMCIDR0 can be accessed through the internal memory-mapped interface and the external debug interface, offset 0xFF0.

Component Identification Register 1

The ROMCIDR1 characteristics are:

Purpose Provides information to identify an external debug component.

Usage constraints This register is accessible as follows:

Off	DLK	OSLK	EDAD	SLK	Default
-	-	-	-	-	RO

[Table 11-1 on page 11-5](#) describes the condition codes.

Configurations The ROMCIDR1 is in the Debug power domain.

Attributes See the register summary in [Table 11-28 on page 11-41](#).

[Figure 11-28](#) shows the ROMCIDR1 bit assignments.

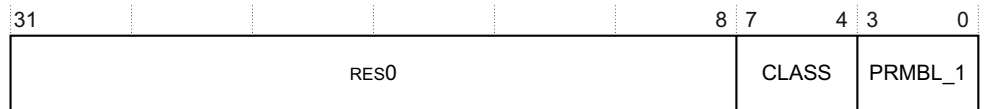

Figure 11-28 ROMCIDR1 bit assignments

Table 11-40 shows the ROMCIDR1 bit assignments.

Table 11-40 ROMCIDR1 bit assignments

Bits	Name	Function
[31:8]	-	Reserved, RES0.
[7:4]	CLASS	0x1 Component Class. For a ROM table.
[3:0]	PRMBL_1	0x0 Preamble.

The ROMCIDR1 can be accessed through the internal memory-mapped interface and the external debug interface, offset 0xFF4.

Component Identification Register 2

The ROMCIDR2 characteristics are:

Purpose Provides information to identify an external debug component.

Usage constraints This register is accessible as follows:

Off	DLK	OSLK	EDAD	SLK	Default
-	-	-	-	-	RO

Table 11-1 on page 11-5 describes the condition codes.

Configurations The ROMCIDR2 is in the Debug power domain.

Attributes See the register summary in Table 11-28 on page 11-41.

Figure 11-29 shows the ROMCIDR2 bit assignments.

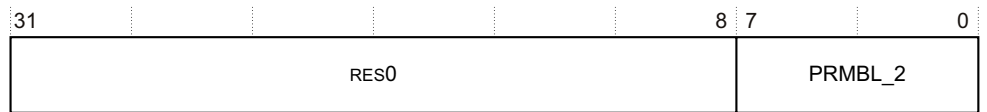

Figure 11-29 ROMCIDR2 bit assignments

Table 11-41 shows the ROMCIDR2 bit assignments.

Table 11-41 ROMCIDR2 bit assignments

Bits	Name	Function
[31:8]	-	Reserved, RES0.
[7:0]	PRMBL_2	0x05 Preamble byte 2.

The ROMCIDR2 can be accessed through the internal memory-mapped interface and the external debug interface, offset 0xFF8.

Component Identification Register 3

The ROMCIDR3 characteristics are:

Purpose Provides information to identify an external debug component.

Usage constraints This register is accessible as follows:

Off	DLK	OSLK	EDAD	SLK	Default
-	-	-	-	-	RO

Table 11-1 on page 11-5 describes the condition codes.

Configurations The ROMCIDR3 is in the Debug power domain.

Attributes See the register summary in Table 11-28 on page 11-41.

Figure 11-30 shows the ROMCIDR3 bit assignments.

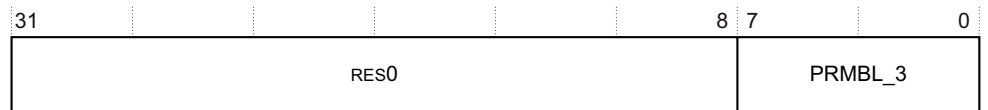

Figure 11-30 ROMCIDR3 bit assignments

Table 11-42 shows the ROMCIDR3 bit assignments.

Table 11-42 ROMCIDR3 bit assignments

Bits	Name	Function
[31:8]	-	Reserved, RES0.
[7:0]	PRMBL_3	0xB1 Preamble byte 3.

The ROMCIDR3 can be accessed through the internal memory-mapped interface and the external debug interface, offset 0xFFC.

Chapter 12

Performance Monitor Unit

This chapter describes the *Performance Monitor Unit* (PMU) and the registers that it uses. It contains the following sections:

- *About the PMU* on page 12-2.
- *PMU functional description* on page 12-3.
- *AArch64 PMU register summary* on page 12-5.
- *AArch64 PMU register descriptions* on page 12-7.
- *AArch32 PMU register summary* on page 12-14.
- *AArch32 PMU register descriptions* on page 12-16.
- *Memory-mapped register summary* on page 12-23.
- *Memory-mapped register descriptions* on page 12-26.
- *Events* on page 12-36.
- *Interrupts* on page 12-40.
- *Exporting PMU events* on page 12-41.

12.1 About the PMU

The Cortex-A53 processor includes performance monitors that implement the ARM PMUv3 architecture. These enable you to gather various statistics on the operation of the processor and its memory system during runtime. These provide useful information about the behavior of the processor that you can use when debugging or profiling code.

The PMU provides six counters. Each counter can count any of the events available in the processor. The absolute counts recorded might vary because of pipeline effects. This has negligible effect except in cases where the counters are enabled for a very short time.

12.2 PMU functional description

This section describes the functionality of the PMU in:

- [Event interface](#).
- [System register and APB interface](#).
- [Counters](#).
- [PMU register interfaces](#).
- [External register access permissions on page 12-4](#).

Figure 12-1 shows the various major blocks inside the PMU.

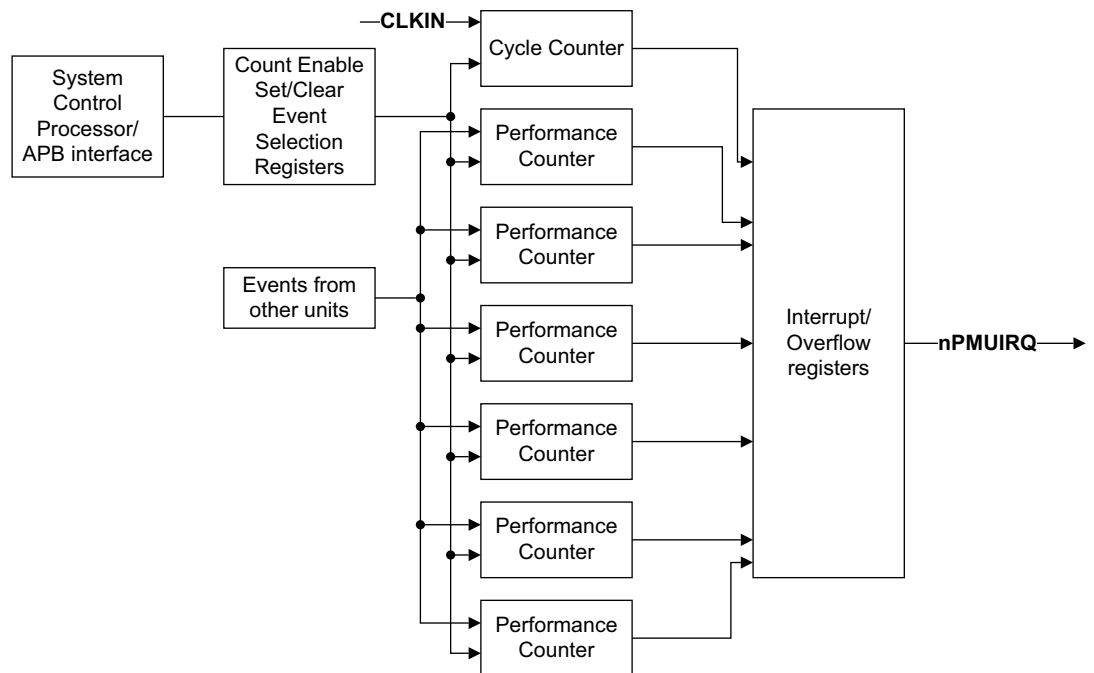

Figure 12-1 PMU block diagram

12.2.1 Event interface

Events from all other units from across the design are provided to the PMU.

12.2.2 System register and APB interface

You can program the PMU registers using the system registers or external APB interface.

12.2.3 Counters

The PMU has 32-bit counters that increment when they are enabled based on events and a 64-bit cycle counter.

12.2.4 PMU register interfaces

The Cortex-A53 processor supports access to the performance monitor registers from the internal system register interface and a memory-mapped interface. External access to the performance monitor registers is also provided with the APB slave port. See [External debug interface on page 11-37](#).

12.2.5 External register access permissions

External access permission to the PMU registers is subject to the conditions at the time of the access. [Table 12-1](#) describes the processor response to accesses through the external debug and memory-mapped interfaces.

Table 12-1 External register conditions

Name	Condition	Description
Off	EDPRSR.PU is 0	Processor power domain is completely off, or in a low-power state where the processor power domain registers cannot be accessed.
DLK	EDPRSR.DLK is 1	OS Double Lock is locked.
OSLK	OSLSR_EL1.OSLK is 1	OS Lock is locked.
EPMAD	AllowExternalPMUAccess() == FALSE	External performance monitors access is disabled. When an error is returned because of an EPMAD condition code, and this is the highest priority error condition, EDPRSR.SPMAD is set to 1. Otherwise SPMAD is unchanged.
SLK	Memory-mapped interface only	Software lock is locked. For the external debug interface, ignore this column.
Default	-	None of the conditions apply, normal access.

[Table 12-2](#) shows an example of external register condition codes for access to a performance monitor register. To determine the access permission for the register, scan the columns from left to right. Stop at the first column whose condition is true, the entry gives the register access permission and scanning stops.

Table 12-2 External register condition code example

Off	DLK	OSLK	EPMAD	SLK	Default
-	-	-	-	RO/WI	RO

12.3 AArch64 PMU register summary

The PMU counters and their associated control registers are accessible in the AArch64 Execution state with MRS and MSR instructions.

Table 12-3 gives a summary of the Cortex-A53 PMU registers in the AArch64 Execution state. For those registers not described in this chapter, see the *ARM® Architecture Reference Manual ARMv8, for ARMv8-A architecture profile*.

Table 12-3 PMU register summary in the AArch64 Execution state

Name	Type	Width	Description
PMCR_EL0	RW	32	<i>Performance Monitors Control Register on page 12-7</i>
PMCNTENSET_EL0	RW	32	Performance Monitors Count Enable Set Register
PMCNTENCLR_EL0	RW	32	Performance Monitors Count Enable Clear Register
PMOVSCLR_EL0	RW	32	Performance Monitors Overflow Flag Status Register
PMSWINC_EL0	WO	32	Performance Monitors Software Increment Register
PMSELR_EL0	RW	32	Performance Monitors Event Counter Selection Register
PMCEID0_EL0	RO	32	<i>Performance Monitors Common Event Identification Register 0 on page 12-9</i>
PMCEID1_EL0	RO	32	<i>Performance Monitors Common Event Identification Register 1 on page 12-12</i>
PMCCNTR_EL0	RW	64	Performance Monitors Cycle Count Register
PMXEVTYPER_EL0	RW	32	Performance Monitors Selected Event Type and Filter Register
PMCCFILTR_EL0	RW	32	Performance Monitors Cycle Count Filter Register
PMXEVCNTR0_EL0	RW	32	Performance Monitors Selected Event Count Register
PMUSERENR_EL0	RW	32	Performance Monitors User Enable Register
PMINTENSET_EL1	RW	32	Performance Monitors Interrupt Enable Set Register
PMINTENCLR_EL1	RW	32	Performance Monitors Interrupt Enable Clear Register
PMOVSSET_EL0	RW	32	Performance Monitors Overflow Flag Status Set Register
PMEVCNTR0_EL0	RW	32	Performance Monitors Event Count Registers
PMEVCNTR1_EL0	RW	32	
PMEVCNTR2_EL0	RW	32	
PMEVCNTR3_EL0	RW	32	
PMEVCNTR4_EL0	RW	32	
PMEVCNTR5_EL0	RW	32	

Table 12-3 PMU register summary in the AArch64 Execution state (continued)

Name	Type	Width	Description
PMEVTYPER0_EL0	RW	32	Performance Monitors Event Type Registers
PMEVTYPER1_EL0	RW	32	
PMXVTYPER2_EL0	RW	32	
PMEVTYPER3_EL0	RW	32	
PMEVTYPER4_EL0	RW	32	
PMEVTYPER5_EL0	RW	32	
PMCCFILTR_EL0	RW	32	Performance Monitors Cycle Count Filter Register

12.4 AArch64 PMU register descriptions

This section describes the Cortex-A53 processor PMU registers in the AArch64 Execution state. [Table 12-3 on page 12-5](#) provides cross-references to individual registers.

12.4.1 Performance Monitors Control Register

The PMCR_EL0 characteristics are:

Purpose Provides details of the Performance Monitors implementation, including the number of counters implemented, and configures and controls the counters.

Usage constraints This register is accessible as follows:

EL0	EL1 (NS)	EL1 (S)	EL2	EL3 (SCR.NS = 1)	EL3 (SCR.NS = 0)
RW	RW	RW	RW	RW	RW

This register is accessible at EL0 when PMUSERENR_EL0.EN is set to 1.

Configurations The PMCR_EL0 is architecturally mapped to the AArch32 PMCR register. See [Performance Monitors Control Register on page 12-16](#).

Attributes PMCR_EL0 is a 32-bit register.

[Figure 12-2](#) shows the PMCR_EL0 bit assignments.

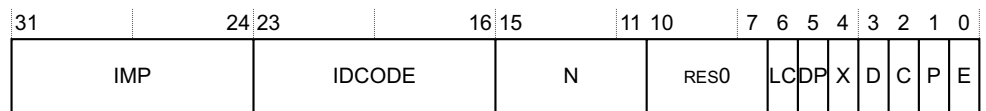

Figure 12-2 PMCR_EL0 bit assignments

[Table 12-4](#) shows the PMCR_EL0 bit assignments.

Table 12-4 PMCR_EL0 bit assignments

Bits	Name	Function
[31:24]	IMP	Implementer code: 0x41 ARM. This is a read-only field.
[23:16]	IDCODE	Identification code: 0x03 Cortex-A53. This is a read-only field.
[15:11]	N	Number of event counters. 0b00110 Six counters.
[10:7]	-	Reserved, RES0.
[6]	LC	Long cycle count enable. Determines which PMCCNTR_EL0 bit generates an overflow recorded in PMOVSr[31]. The possible values are: 0 Overflow on increment that changes PMCCNTR_EL0[31] from 1 to 0. 1 Overflow on increment that changes PMCCNTR_EL0[63] from 1 to 0.

Table 12-4 PMCR_EL0 bit assignments (continued)

Bits	Name	Function
[5]	DP	<p>Disable cycle counter, PMCCNTR_EL0 when event counting is prohibited:</p> <p>0 Cycle counter operates regardless of the non-invasive debug authentication settings. This is the reset value.</p> <p>1 Cycle counter is disabled if non-invasive debug is not permitted and enabled.</p> <p>This bit is read/write.</p>
[4]	X	<p>Export enable. This bit permits events to be exported to another debug device, such as a trace macrocell, over an event bus:</p> <p>0 Export of events is disabled. This is the reset value.</p> <p>1 Export of events is enabled.</p> <p>This bit is read/write and does not affect the generation of Performance Monitors interrupts on the nPMUIRQ pin.</p>
[3]	D	<p>Clock divider:</p> <p>0 When enabled, PMCCNTR_EL0 counts every clock cycle. This is the reset value.</p> <p>1 When enabled, PMCCNTR_EL0 counts every 64 clock cycles.</p> <p>This bit is read/write.</p>
[2]	C	<p>Clock counter reset. This bit is WO. The effects of writing to this bit are:</p> <p>0 No action. This is the reset value.</p> <p>1 Reset PMCCNTR_EL0 to 0.</p> <p>This bit is always RAZ.</p> <p>———— Note —————</p> <p>Resetting PMCCNTR does not clear the PMCCNTR_EL0 overflow bit to 0. See the <i>ARM® Architecture Reference Manual ARMv8, for ARMv8-A architecture profile</i>. for more information.</p>
[1]	P	<p>Event counter reset. This bit is WO. The effects of writing to this bit are:</p> <p>0 No action. This is the reset value.</p> <p>1 Reset all event counters, not including PMCCNTR_EL0, to zero.</p> <p>This bit is always RAZ.</p> <p>In Non-secure EL0 and EL1, a write of 1 to this bit does not reset event counters that MDCR_EL2.HPMN reserves for EL2 use.</p> <p>In EL2 and EL3, a write of 1 to this bit resets all the event counters.</p> <p>Resetting the event counters does not clear any overflow bits to 0.</p>
[0]	E	<p>Enable. The possible values of this bit are:</p> <p>0 All counters, including PMCCNTR_EL0, are disabled. This is the reset value.</p> <p>1 All counters are enabled.</p> <p>This bit is RW.</p> <p>In Non-secure EL0 and EL1, this bit does not affect the operation of event counters that MDCR_EL2.HPMN reserves for EL2 use.</p> <p>On Warm reset, the field resets to 0.</p>

To access the PMCR_EL0:

```
MRS <Xt>, PMCR_EL0 ; Read PMCR_EL0 into Xt
MSR PMCR_EL0, <Xt> ; Write Xt to PMCR_EL0
```

To access the PMCR in AArch32 Execution state, read or write the CP15 registers with:

```
MRC p15, 0, <Rt>, c9, c12, 0; Read Performance Monitor Control Register
MCR p15, 0, <Rt>, c9, c12, 0; Write Performance Monitor Control Register
```

The PMCR_EL0 can be accessed through the internal memory-mapped interface and the external debug interface, offset 0xE04.

12.4.2 Performance Monitors Common Event Identification Register 0

The PMCEID0_EL0 characteristics are:

Purpose Defines which common architectural and common microarchitectural feature events are implemented.

Usage constraints This register is accessible as follows:

EL0	EL1 (NS)	EL1 (S)	EL2	EL3 (SCR.NS = 1)	EL3 (SCR.NS = 0)
Config	RO	RO	RO	RO	RO

This register is accessible at EL0 when PMUSERENR_EL0.EN is set to 1.

Configurations The PMCEID0_EL0 is architecturally mapped to:

- The AArch32 register PMCEID0. See *Performance Monitors Common Event Identification Register 0* on page 12-18.
- The external register PMCEID0_EL0.

Attributes PMCEID0_EL0 is a 32-bit register.

Figure 12-3 shows the PMCEID0_EL0 bit assignments.

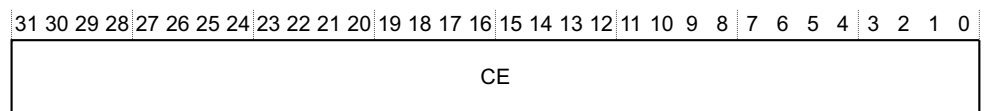

Figure 12-3 PMCEID0_EL0 bit assignments

Table 12-6 on page 12-10 shows the PMCEID0_EL0 bit assignments

Table 12-5 PMCEID0_EL0 bit assignments

Bits	Name	Function
[31:0]	CE[31:0]	Common architectural and microarchitectural feature events that can be counted by the PMU event counters. For each bit described in Table 12-6 on page 12-10, the event is implemented if the bit is set to 1, or not implemented if the bit is set to 0.

Table 12-6 PMU common events

Bit	Event number	Event mnemonic	Description
[31]	0x1F	L1D_CACHE_ALLOCATE	L1 Data cache allocate: 0 This event is not implemented.
[30]	0x1E	CHAIN	Chain. For odd-numbered counters, counts once for each overflow of the preceding even-numbered counter. For even-numbered counters, does not count: 1 This event is implemented.
[29]	0x1D	BUS_CYCLES	Bus cycle: 1 This event is implemented.
[28]	0x1C	TTBR_WRITE_RETIRED	TTBR write, architecturally executed, condition check pass - write to translation table base: 0 This event is not implemented.
[27]	0x1B	INST_SPEC	Instruction speculatively executed: 0 This event is not implemented.
[26]	0x1A	MEMORY_ERROR	Local memory error: 1 This event is implemented.
[25]	0x19	BUS_ACCESS	Bus access: 1 This event is implemented.
[24]	0x18	L2D_CACHE_WB	L2 Data cache Write-Back: 0 This event is not implemented if the Cortex-A53 processor has been configured without an L2 cache. 1 This event is implemented if the Cortex-A53 processor has been configured with an L2 cache.
[23]	0x17	L2D_CACHE_REFILL	L2 Data cache refill: 0 This event is not implemented if the Cortex-A53 processor has been configured without an L2 cache. 1 This event is implemented if the Cortex-A53 processor has been configured with an L2 cache.
[22]	0x16	L2D_CACHE	L2 Data cache access: 0 This event is not implemented if the Cortex-A53 processor has been configured without an L2 cache. 1 This event is implemented if the Cortex-A53 processor has been configured with an L2 cache.
[21]	0x15	L1D_CACHE_WB	L1 Data cache Write-Back: 1 This event is implemented.
[20]	0x14	L1I_CACHE	L1 Instruction cache access: 1 This event is implemented.
[19]	0x13	MEM_ACCESS	Data memory access: 1 This event is implemented.
[18]	0x12	BR_PRED	Predictable branch speculatively executed: 1 This event is implemented.
[17]	0x11	CPU_CYCLES	Cycle: 1 This event is implemented.

Table 12-6 PMU common events (continued)

Bit	Event number	Event mnemonic	Description
[16]	0x10	BR_MIS_PRED	Mispredicted or not predicted branch speculatively executed: 1 This event is implemented.
[15]	0x0F	UNALIGNED_LDST_RETIRED	Instruction architecturally executed, condition check pass - unaligned load or store: 1 This event is implemented.
[14]	0x0E	BR_RETURN_RETIRED	Instruction architecturally executed, condition check pass - procedure return: 0 This event is not implemented.
[13]	0x0D	BR_IMMED_RETIRED	Instruction architecturally executed - immediate branch: 1 This event is implemented.
[12]	0x0C	PC_WRITE_RETIRED	Instruction architecturally executed, condition check pass - software change of the PC: 1 This event is implemented.
[11]	0x0B	CID_WRITE_RETIRED	Instruction architecturally executed, condition check pass - write to CONTEXTIDR: 1 This event is implemented.
[10]	0x0A	EXC_RETURN	Instruction architecturally executed, condition check pass - exception return: 1 This event is implemented.
[9]	0x09	EXC_TAKEN	Exception taken: 1 This event is implemented.
[8]	0x08	INST_RETIRED	Instruction architecturally executed: 1 This event is implemented.
[7]	0x07	ST_RETIRED	Instruction architecturally executed, condition check pass - store: 1 This event is implemented.
[6]	0x06	LD_RETIRED	Instruction architecturally executed, condition check pass - load: 1 This event is implemented.
[5]	0x05	L1D_TLB_REFILL	L1 Data TLB refill: 1 This event is implemented.
[4]	0x04	L1D_CACHE	L1 Data cache access: 1 This event is implemented.
[3]	0x03	L1D_CACHE_REFILL	L1 Data cache refill: 1 This event is implemented.
[2]	0x02	L1I_TLB_REFILL	L1 Instruction TLB refill: 1 This event is implemented.
[1]	0x01	L1I_CACHE_REFILL	L1 Instruction cache refill: 1 This event is implemented.
[0]	0x00	SW_INCR	Instruction architecturally executed, condition check pass - software increment: 1 This event is implemented.

To access the PMCEID0_EL0 in AArch64 Execution state, read or write the register with:

MRS <Xt>, PMCEID0_EL0; Read Performance Monitor Common Event Identification Register 0

To access the PMCEID0 in AArch32 Execution state, read or write the CP15 register with:

MRC p15, 0, <Rt>, c9, c12, 6; Read Performance Monitor Common Event Identification Register 0

The PMCEID0_EL0 can be accessed through the internal memory-mapped interface and the external debug interface, offset 0xE20.

12.4.3 Performance Monitors Common Event Identification Register 1

The PMCEID1_EL0 characteristics are:

Purpose Defines which common architectural and common microarchitectural feature events are implemented.

Usage constraints This register is accessible as follows:

EL0	EL1 (NS)	EL1 (S)	EL2	EL3 (SCR.NS = 1)	EL3 (SCR.NS = 0)
Config	RO	RO	RO	RO	RO

This register is accessible at EL0 when PMUSERENR_EL0.EN is set to 1.

Configurations The PMCEID1_EL0 is architecturally mapped to:

- The AArch32 register PMCEID1. See *Performance Monitors Common Event Identification Register 1* on page 12-21.
- The external register PMCEID1_EL0.

Attributes PMCEID1_EL0 is a 32-bit register.

Figure 12-4 shows the PMCEID1_EL0 bit assignments.

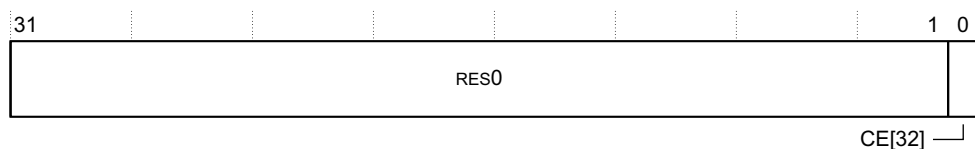

Figure 12-4 PMCEID1 bit assignments

Table 12-7 shows the PMCEID1_EL0 bit assignments.

Table 12-7 PMCEID1 bit assignments

Bits	Name	Function
[31:1]	-	
[32]	CE[32]	Common architectural and microarchitectural feature events that can be counted by the PMU event counters. For each bit described in Table 12-8 on page 12-13, the event is implemented if the bit is set to 1, or not implemented if the bit is set to 0.

Table 12-8 PMU common events

Bit	Event number	Event mnemonic		Description
[0]	0x20	L2D_CACHE_ALLOCATE	0	This event is not implemented.

To access the PMCEID1_EL0:

MRS <Xt>, PMCEID1_EL0; Read Performance Monitor Common Event Identification Register 0

The PMCEID1_EL0 can be accessed through the internal memory-mapped interface and the external debug interface, offset 0xE24.

12.5 AArch32 PMU register summary

The PMU counters and their associated control registers are accessible in the AArch32 Execution state from the internal CP15 system register interface with MCR and MRC instructions for 32-bit registers and MCRR and MRRC for 64-bit registers.

Table 12-9 gives a summary of the Cortex-A53 PMU registers in the AArch32 Execution state. For those registers not described in this chapter, see the *ARM® Architecture Reference Manual ARMv8, for ARMv8-A architecture profile*.

See the *Memory-mapped register summary* on page 12-23 for a complete list of registers that are accessible from the internal memory-mapped interface or the external debug interface.

Table 12-9 PMU register summary in the AArch32 Execution state

CRn	Op1	CRm	Op2	Name	Type	Width	Description
c9	0	c12	0	PMCR	RW	32	<i>Performance Monitors Control Register on page 12-16</i>
c9	0	c12	1	PMCNTENSET	RW	32	Performance Monitors Count Enable Set Register
c9	0	c12	2	PMCNTENCLR	RW	32	Performance Monitors Count Enable Clear Register
c9	0	c12	3	PMOVSr	RW	32	Performance Monitors Overflow Flag Status Register
c9	0	c12	4	PMSWINC	WO	32	Performance Monitors Software Increment Register
c9	0	c12	5	PMSELR	RW	32	Performance Monitors Event Counter Selection Register
c9	0	c12	6	PMCEID0	RO	32	<i>Performance Monitors Common Event Identification Register 0 on page 12-18</i>
c9	0	c12	7	PMCEID1	RO	32	<i>Performance Monitors Common Event Identification Register 1 on page 12-21</i>
c9	0	c13	0	PMCCNTR[31:0]	RW	32	Performance Monitors Cycle Count Register
-	0	c9	-	PMCCNTR[63:0]	RW	64	
c9	0	c13	1	PMXEVTYPER	RW	32	Performance Monitors Selected Event Type Register
				PMCCFILTR	RW	32	Performance Monitors Cycle Count Filter Register
c9	0	c13	2	PMXVCNTR	RW	32	Performance Monitors Selected Event Count Register
c9	0	c14	0	PMUSERENR	RW	32	Performance Monitors User Enable Register
c9	0	c14	1	PMINTENSET	RW	32	Performance Monitors Interrupt Enable Set Register
c9	0	c14	2	PMINTENCLR	RW	32	Performance Monitors Interrupt Enable Clear Register
c9	0	c14	3	PMOVSSET	RW	32	Performance Monitor Overflow Flag Status Set Register
c14	0	c8	0	PMEVCNTR0	RW	32	Performance Monitor Event Count Registers
c14	0	c8	1	PMEVCNTR1	RW	32	
c14	0	c8	2	PMEVCNTR2	RW	32	
c14	0	c8	3	PMEVCNTR3	RW	32	
c14	0	c8	4	PMEVCNTR4	RW	32	
c14	0	c8	5	PMEVCNTR5	RW	32	

Table 12-9 PMU register summary in the AArch32 Execution state (continued)

CRn	Op1	CRm	Op2	Name	Type	Width	Description
c14	0	c12	0	PMEVTYPER0	RW	32	Performance Monitors Event Type Registers
c14	0	c12	1	PMEVTYPER1	RW	32	
c14	0	c12	2	PMEVTYPER2	RW	32	
c14	0	c12	3	PMEVTYPER3	RW	32	
c14	0	c12	4	PMEVTYPER4	RW	32	
c14	0	c12	5	PMEVTYPER5	RW	32	
c14	0	c15	7	PMCCFILTR	RW	32	Performance Monitors Cycle Count Filter Register

12.6 AArch32 PMU register descriptions

This section describes the Cortex-A53 processor PMU registers in the AArch32 Execution state. [Table 12-9 on page 12-14](#) provides cross-references to individual registers.

12.6.1 Performance Monitors Control Register

The PMCR characteristics are:

Purpose Provides details of the Performance Monitors implementation, including the number of counters implemented, and configures and controls the counters.

Usage constraints This register is accessible as follows:

EL0 (NS)	EL0 (S)	EL1 (NS)	EL1 (S)	EL2	EL3 (SCR.NS = 1)	EL3 (SCR.NS = 0)
Config	Config	RW	RW	RW	RW	RW

This register is accessible at EL0 when PMUSERENR_EL0.EN is set to 1.

Configurations The PMCR is architecturally mapped to:

- The AArch64 PMCR_EL0 register. See [Performance Monitors Control Register on page 12-7](#).
- The external PMCR_EL0 register.

There is one copy of this register that is used in both Secure and Non-secure states.

Attributes PMCR is a 32-bit register.

[Figure 12-5](#) shows the PMCR bit assignments.

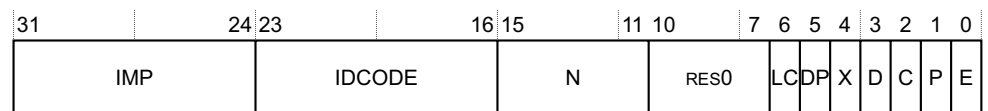

Figure 12-5 PMCR bit assignments

[Table 12-10](#) shows the PMCR bit assignments.

Table 12-10 PMCR bit assignments

Bits	Name	Function
[31:24]	IMP	Implementer code: 0x41 ARM. This is a read-only field.
[23:16]	IDCODE	Identification code: 0x03 Cortex-A53. This is a read-only field.
[15:11]	N	Number of event counters. 0b00110 Six counters.
[10:7]	-	Reserved, RES0.

Table 12-10 PMCR bit assignments (continued)

Bits	Name	Function
[6]	LC	<p>Long cycle count enable. Determines which PMCCNTR_EL0 bit generates an overflow recorded in PMOVSR[31]. The possible values are:</p> <p>0 Overflow on increment that changes PMCCNTR_EL0[31] from 1 to 0.</p> <p>1 Overflow on increment that changes PMCCNTR_EL0[63] from 1 to 0.</p>
[5]	DP	<p>Disable cycle counter, PMCCNTR_EL0 when event counting is prohibited:</p> <p>0 Cycle counter operates regardless of the non-invasive debug authentication settings. This is the reset value.</p> <p>1 Cycle counter is disabled if non-invasive debug is not permitted and enabled.</p> <p>This bit is read/write.</p>
[4]	X	<p>Export enable. This bit permits events to be exported to another debug device, such as a trace macrocell, over an event bus:</p> <p>0 Export of events is disabled. This is the reset value.</p> <p>1 Export of events is enabled.</p> <p>This bit is read/write and does not affect the generation of Performance Monitors interrupts on the nPMUIRQ pin.</p>
[3]	D	<p>Clock divider:</p> <p>0 When enabled, PMCCNTR_EL0 counts every clock cycle. This is the reset value.</p> <p>1 When enabled, PMCCNTR_EL0 counts every 64 clock cycles.</p> <p>This bit is read/write.</p>
[2]	C	<p>Clock counter reset. This bit is WO. The effects of writing to this bit are:</p> <p>0 No action. This is the reset value.</p> <p>1 Reset PMCCNTR_EL0 to 0.</p> <p>This bit is always RAZ.</p> <p style="text-align: center;">Note</p> <p>Resetting PMCCNTR does not clear the PMCCNTR_EL0 overflow bit to 0. See the <i>ARM® Architecture Reference Manual ARMv8, for ARMv8-A architecture profile</i> for more information.</p>
[1]	P	<p>Event counter reset. This bit is WO. The effects of writing to this bit are:</p> <p>0 No action. This is the reset value.</p> <p>1 Reset all event counters, not including PMCCNTR_EL0, to zero.</p> <p>This bit is always RAZ.</p> <p>In Non-secure EL0 and EL1, a write of 1 to this bit does not reset event counters that MDCR_EL2.HPMN reserves for EL2 use.</p> <p>In EL2 and EL3, a write of 1 to this bit resets all the event counters.</p> <p>Resetting the event counters does not clear any overflow bits to 0.</p>
[0]	E	<p>Enable. The possible values of this bit are:</p> <p>0 All counters, including PMCCNTR_EL0, are disabled. This is the reset value.</p> <p>1 All counters are enabled.</p> <p>This bit is RW.</p> <p>In Non-secure EL0 and EL1, this bit does not affect the operation of event counters that MDCR_EL2.HPMN reserves for EL2 use.</p> <p>On Warm reset, the field resets to 0.</p>

To access the PMCR:

MRC p15, 4, <Rt>, c12, c0, 0 ; Read PMCR into Rt
MCR p15, 4, <Rt>, c12, c0, 0 ; Write Rt to PMCR

The PMCR can be accessed through the internal memory-mapped interface and the external debug interface, offset 0xE04.

12.6.2 Performance Monitors Common Event Identification Register 0

The PMCEID0 characteristics are:

Purpose Defines which common architectural and common microarchitectural feature events are implemented.

Usage constraints This register is accessible as follows:

EL0 (NS)	EL0 (S)	EL1 (NS)	EL1 (S)	EL2	EL3 (SCR.NS = 1)	EL3 (SCR.NS = 0)
Config	Config	RO	RO	RO	RO	RO

This register is accessible at EL0 when PMUSERENR_EL0.EN is set to 1.

Configurations The PMCEID0 is architecturally mapped to:

- The AArch64 register PMCEID0_EL0. See [Performance Monitors Common Event Identification Register 0](#) on page 12-9.
- The external register PMCEID0_EL0.

There is one copy of this register that is used in both Secure and Non-secure states.

Attributes PMCEID0 is a 32-bit register.

Figure 12-6 shows the PMCEID0 bit assignments.

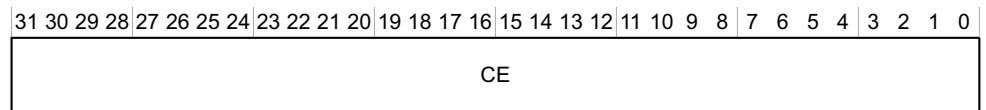

Figure 12-6 PMCEID0 bit assignments

Table 12-11 shows the PMCEID0 bit assignments with event implemented or not implemented when the associated bit is set to 1 or 0. See the *ARM® Architecture Reference Manual ARMv8, for ARMv8-A architecture profile* for more information about these events.

Table 12-11 PMCEID0 bit assignments

Bits	Name	Function
[31:0]	CE[31:0]	Common architectural and microarchitectural feature events that can be counted by the PMU event counters. For each bit described in Table 12-12 on page 12-19 , the event is implemented if the bit is set to 1, or not implemented if the bit is set to 0.

Table 12-12 PMU events

Bit	Event number	Event mnemonic	Description
[31]	0x1F	L1D_CACHE_ALLOCATE	L1 Data cache allocate: 0 This event is not implemented.
[30]	0x1E	CHAIN	Chain. For odd-numbered counters, counts once for each overflow of the preceding even-numbered counter. For even-numbered counters, does not count: 1 This event is implemented.
[29]	0x1D	BUS_CYCLES	Bus cycle: 1 This event is implemented.
[28]	0x1C	TTBR_WRITE_RETIRED	TTBR write, architecturally executed, condition check pass - write to translation table base: 0 This event is not implemented.
[27]	0x1B	INST_SPEC	Instruction speculatively executed: 0 This event is not implemented.
[26]	0x1A	MEMORY_ERROR	Local memory error: 1 This event is implemented.
[25]	0x19	BUS_ACCESS	Bus access: 1 This event is implemented.
[24]	0x18	L2D_CACHE_WB	L2 Data cache Write-Back: 0 This event is not implemented if the Cortex-A53 processor has been configured without an L2 cache. 1 This event is implemented if the Cortex-A53 processor has been configured with an L2 cache.
[23]	0x17	L2D_CACHE_REFILL	L2 Data cache refill: 0 This event is not implemented if the Cortex-A53 processor has been configured without an L2 cache. 1 This event is implemented if the Cortex-A53 processor has been configured with an L2 cache.
[22]	0x16	L2D_CACHE	L2 Data cache access: 0 This event is not implemented if the Cortex-A53 processor has been configured without an L2 cache. 1 This event is implemented if the Cortex-A53 processor has been configured with an L2 cache.
[21]	0x15	L1D_CACHE_WB	L1 Data cache Write-Back: 1 This event is implemented.
[20]	0x14	L1I_CACHE	L1 Instruction cache access: 1 This event is implemented.
[19]	0x13	MEM_ACCESS	Data memory access: 1 This event is implemented.
[18]	0x12	BR_PRED	Predictable branch speculatively executed: 1 This event is implemented.
[17]	0x11	CPU_CYCLES	Cycle: 1 This event is implemented.

Table 12-12 PMU events (continued)

Bit	Event number	Event mnemonic	Description
[16]	0x10	BR_MIS_PRED	Mispredicted or not predicted branch speculatively executed: 1 This event is implemented.
[15]	0x0F	UNALIGNED_LDST_RETIRED	Instruction architecturally executed, condition check pass - unaligned load or store: 1 This event is implemented.
[14]	0x0E	BR_RETURN_RETIRED	Instruction architecturally executed, condition check pass - procedure return: 0 This event is not implemented.
[13]	0x0D	BR_IMMED_RETIRED	Instruction architecturally executed - immediate branch: 1 This event is implemented.
[12]	0x0C	PC_WRITE_RETIRED	Instruction architecturally executed, condition check pass - software change of the PC: 1 This event is implemented.
[11]	0x0B	CID_WRITE_RETIRED	Instruction architecturally executed, condition check pass - write to CONTEXTIDR: 1 This event is implemented.
[10]	0x0A	EXC_RETURN	Instruction architecturally executed, condition check pass - exception return: 1 This event is implemented.
[9]	0x09	EXC_TAKEN	Exception taken: 1 This event is implemented.
[8]	0x08	INST_RETIRED	Instruction architecturally executed: 1 This event is implemented.
[7]	0x07	ST_RETIRED	Instruction architecturally executed, condition check pass - store: 1 This event is implemented.
[6]	0x06	LD_RETIRED	Instruction architecturally executed, condition check pass - load: 1 This event is implemented.
[5]	0x05	L1D_TLB_REFILL	L1 Data TLB refill: 1 This event is implemented.
[4]	0x04	L1D_CACHE	L1 Data cache access: 1 This event is implemented.
[3]	0x03	L1D_CACHE_REFILL	L1 Data cache refill: 1 This event is implemented.
[2]	0x02	L1I_TLB_REFILL	L1 Instruction TLB refill: 1 This event is implemented.
[1]	0x01	L1I_CACHE_REFILL	L1 Instruction cache refill: 1 This event is implemented.
[0]	0x00	SW_INCR	Instruction architecturally executed, condition check pass - software increment: 1 This event is implemented.

To access the PMCEID0:

MRC p15,0,<Rt>,c9,c12,6 ; Read PMCEID0 into Rt

The PMCEID0 can be accessed through the internal memory-mapped interface and the external debug interface, offset 0xE20.

12.6.3 Performance Monitors Common Event Identification Register 1

The PMCEID1 characteristics are:

Purpose Defines which common architectural and common microarchitectural feature events are implemented.

Usage constraints This register is accessible as follows:

EL0 (NS)	EL0 (S)	EL1 (NS)	EL1 (S)	EL2	EL3 (SCR.NS = 1)	EL3 (SCR.NS = 0)
Config	Config	RO	RO	RO	RO	RO

This register is accessible at EL0 when PMUSERENR_EL0.EN is set to 1

Configurations The PMCEID1 is architecturally mapped to:

- The AArch32 register PMCEID1_EL0. See *Performance Monitors Common Event Identification Register 1* on page 12-12.
- The external register PMCEID1_EL0.

There is one copy of this register that is used in both Secure and Non-secure states.

Attributes PMCEID1 is a 32-bit register.

Figure 12-7 shows the PMCEID1 bit assignments

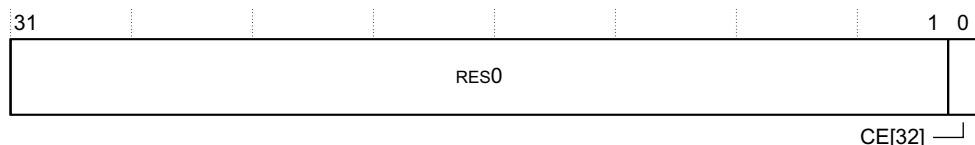

Figure 12-7 PMCEID1 bit assignments

Table 12-13 shows the PMCEID1 bit assignments.

Table 12-13 PMCEID1 bit assignments

Bits	Name	Function
[31:1]	-	-
[32]	CE[32]	Common architectural and microarchitectural feature events that can be counted by the PMU event counters. For each bit described in Table 12-14, the event is implemented if the bit is set to 1, or not implemented if the bit is set to 0.

Table 12-14 PMU common events

Bit	Event number	Event mnemonic	Description
[0]	0x20	L2D_CACHE_ALLOCATE	0 This event is not implemented.

To access the PMCEID1:

MRC p15,0,<Rt>,c9,c12,7 ; Read PMCEID1 into Rt

The PMCEID1 can be accessed through the internal memory-mapped interface and the external debug interface, offset 0xE24.

12.7 Memory-mapped register summary

Table 12-15 shows the PMU registers that are accessible through the internal memory-mapped interface and the external debug interface. For those registers not described in this chapter, see the *ARM® Architecture Reference Manual ARMv8, for ARMv8-A architecture profile*.

Table 12-15 Memory-mapped PMU register summary

Offset	Name	Type	Description
0x000	PMEVCNTR0_EL0	RW	Performance Monitor Event Count Register 0
0x004	-	-	Reserved
0x008	PMEVCNTR1_EL0	RW	Performance Monitor Event Count Register 1
0x00C	-	-	Reserved
0x010	PMEVCNTR2_EL0	RW	Performance Monitor Event Count Register 2
0x014	-	-	Reserved
0x018	PMEVCNTR3_EL0	RW	Performance Monitor Event Count Register 3
0x01C	-	-	Reserved
0x020	PMEVCNTR4_EL0	RW	Performance Monitor Event Count Register 4
0x024	-	-	Reserved
0x028	PMEVCNTR5_EL0	RW	Performance Monitor Event Count Register 5
0x02C-0xF4	-	-	Reserved
0x0F8	PMCCNTR_EL0[31:0]	RW	Performance Monitor Cycle Count Register
0x0FC	PMCCNTR_EL0[63:32]	RW	
0x100-0x3FC	-	-	Reserved
0x400	PMEVTYPER0_EL0	RW	Performance Monitor Event Type Register
0x404	PMEVTYPER1_EL0	RW	
0x408	PMEVTYPER2_EL0	RW	
0x40C	PMEVTYPER3_EL0	RW	
0x410	PMEVTYPER4_EL0	RW	
0x414	PMEVTYPER5_EL0	RW	
0x418-0x478	-	-	Reserved
0x47C	PMCCFILTR_EL0	RW	Performance Monitor Cycle Count Filter Register
0x480-0xBFC	-	-	Reserved
0xC00	PMCNTENSET_EL0	RW	Performance Monitor Count Enable Set Register
0xC04-0xC1C	-	-	Reserved
0xC20	PMCNTENCLR_EL0	RW	Performance Monitor Count Enable Clear Register
0xC24-0xC3C	-	-	Reserved
0xC40	PMINTENSET_EL1	RW	Performance Monitor Interrupt Enable Set Register

Table 12-15 Memory-mapped PMU register summary (continued)

Offset	Name	Type	Description
0xC44-0xC5C	-	-	Reserved
0xC60	PMINTENCLR_EL1	RW	Performance Monitor Interrupt Enable Clear Register
0xC64-0xC7C	-	-	Reserved
0xC80	PMOVSLR_EL0	RW	Performance Monitor Overflow Flag Status Register
0xC84-0xC9C	-	-	Reserved
0xCA0	PMSWINC_EL0	WO	Performance Monitor Software Increment Register
0xCA4-0xCBC	-	-	Reserved
0xCC0	PMOVSSET_EL0	RW	Performance Monitor Overflow Flag Status Set Register
0xCC4-0xDFC	-	-	Reserved
0xE00	PMCFGR	RO	<i>Performance Monitor Configuration Register on page 12-26</i>
0xE04	PMCR_EL0 ^a	RW	Performance Monitors Control Register
0xE08-0xE1C	-	-	Reserved
0xE20	PMCEID0_EL0	RO	<i>Performance Monitors Common Event Identification Register 0 on page 12-9</i>
0xE24	PMCEID1_EL0	RO	Performance Monitor Common Event Identification Register 1
0xE28-0xFA4	-	-	Reserved
0xFA8	PMDEVAFF0	RO	Performance Monitors Device Affinity Register 0, see <i>Multiprocessor Affinity Register on page 4-15</i>
0xFAC	PMDEVAFF1	RO	Performance Monitors Device Affinity Register 1, RES0
0xFB0	PMLAR	WO	Performance Monitor Lock Access Register
0xFB4	PMLSR	RO	Performance Monitor Lock Status Register
0xFB8	PMAUTHSTATUS	RO	Performance Monitor Authentication Status Register
0xFBC	PMDEVARCH		Performance Monitor Device Architecture Register
0xFC0-0xFC8	-	-	Reserved
0xFCC	PMDEVTYPE	RO	Performance Monitor Device Type Register
0xFD0	PMPIDR4	RO	<i>Peripheral Identification Register 4 on page 12-30</i>
0xFD4	PMPIDR5	RO	<i>Peripheral Identification Register 5-7 on page 12-31</i>
0xFD8	PMPIDR6	RO	
0xFDC	PMPIDR7	RO	
0xFE0	PMPIDR0	RO	<i>Peripheral Identification Register 0 on page 12-27</i>
0xFE4	PMPIDR1	RO	<i>Peripheral Identification Register 1 on page 12-28</i>
0xFE8	PMPIDR2	RO	<i>Peripheral Identification Register 2 on page 12-29</i>
0xFEC	PMPIDR3	RO	<i>Peripheral Identification Register 3 on page 12-30</i>
0xFF0	PMCIDR0	RO	<i>Component Identification Register 0 on page 12-32</i>

Table 12-15 Memory-mapped PMU register summary (continued)

Offset	Name	Type	Description
0xFF4	PMCIDR1	RO	<i>Component Identification Register 1 on page 12-32</i>
0xFF8	PMCIDR2	RO	<i>Component Identification Register 2 on page 12-33</i>
0xFFC	PMCIDR3	RO	<i>Component Identification Register 3 on page 12-34</i>

- a. This register is distinct from the PMCR_EL0 system register. It does not have the same value.

12.8 Memory-mapped register descriptions

This section describes the Cortex-A53 processor PMU registers accessible through the memory-mapped and debug interfaces. [Table 12-15 on page 12-23](#) provides cross-references to individual registers.

12.8.1 Performance Monitor Configuration Register

The PMCFGR characteristics are:

Purpose Contains PMU specific configuration data.

Usage constraints The accessibility to the PMCFGR by condition code is:

Off	DLK	OSLK	EPAD	SLK	Default
Error	Error	Error	Error	RO	RO

[Table 12-1 on page 12-4](#) describes the condition codes.

Configurations The PMCFGR is in the processor power domain.

Attributes See the register summary in [Table 12-15 on page 12-23](#).

[Figure 12-8](#) shows the PMCFGR bit assignments.

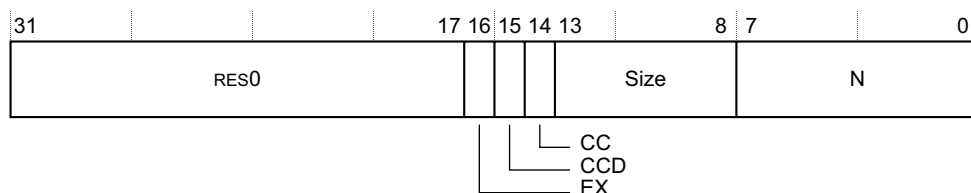

Figure 12-8 PMCFGR bit assignments

[Table 12-16](#) shows the PMCFGR bit assignments.

Table 12-16 PMCFGR bit assignments

Bits	Name	Function
[31:17]	-	Reserved, RES0.
[16]	EX	Export supported. The value is: 1 Export is supported. PMCR_EL0.EX is read/write.
[15]	CCD	Cycle counter has pre-scale. The value is: 1 PMCR_EL0.D is read/write.
[14]	CC	Dedicated cycle counter supported. The value is: 1 Dedicated cycle counter is supported.
[13:8]	Size	Counter size. The value is: 0b111111 64-bit counters.
[7:0]	N	Number of event counters. The value is: 0x06 Six counters.

The PMCFGR can be accessed through the internal memory-mapped interface and the external debug interface, offset 0xE00.

12.8.2 Peripheral Identification Registers

The Peripheral Identification Registers provide standard information required for all components that conform to the ARM PMUv3 architecture. There is a set of eight registers, listed in register number order in [Table 12-17](#).

Table 12-17 Summary of the Peripheral Identification Registers

Register	Value	Offset
Peripheral ID4	0x04	0xFD0
Peripheral ID5	0x00	0xFD4
Peripheral ID6	0x00	0xFD8
Peripheral ID7	0x00	0xFDC
Peripheral ID0	0xD3	0xFE0
Peripheral ID1	0xB9	0xFE4
Peripheral ID2	0x2B	0xFE8
Peripheral ID3	0x00	0xFEC

Only bits[7:0] of each Peripheral ID Register are used, with bits[31:8] reserved. Together, the eight Peripheral ID Registers define a single 64-bit Peripheral ID.

The Peripheral ID registers are:

- [Peripheral Identification Register 0](#).
- [Peripheral Identification Register 1](#) on page 12-28.
- [Peripheral Identification Register 2](#) on page 12-29.
- [Peripheral Identification Register 3](#) on page 12-30.
- [Peripheral Identification Register 4](#) on page 12-30.
- [Peripheral Identification Register 5-7](#) on page 12-31.

Peripheral Identification Register 0

The PMPIDR0 characteristics are:

Purpose Provides information to identify a Performance Monitor component.

Usage constraints The PMPIDR0 can be accessed through the internal memory-mapped interface and the external debug interface.

The accessibility to the PMPIDR0 by condition code is:

Off	DLK	OSLK	EPAD	SLK	Default
-	-	-	-	RO	RO

[Table 12-1](#) on page 12-4 describes the condition codes.

Configurations The PMPIDR0 is in the Debug power domain.

Attributes See the register summary in [Table 12-15 on page 12-23](#).

[Figure 12-9](#) shows the PMPIDR0 bit assignments.

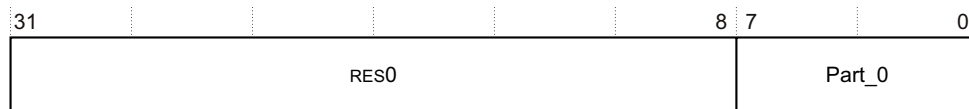

Figure 12-9 PMPIDR0 bit assignments

[Table 12-18](#) shows the PMPIDR0 bit assignments.

Table 12-18 PMPIDR0 bit assignments

Bits	Name	Function
[31:8]	-	Reserved, RES0.
[7:0]	Part_0	0xD3 Least significant byte of the performance monitor part number.

The PMPIDR0 can be accessed through the internal memory-mapped interface and the external debug interface, offset 0xFE0.

Peripheral Identification Register 1

The PMPIDR1 characteristics are:

Purpose Provides information to identify a Performance Monitor component.

Usage constraints The PMPIDR1 can be accessed through the internal memory-mapped interface and the external debug interface.

The accessibility to the PMPIDR1 by condition code is:

Off	DLK	OSLK	EPMAD	SLK	Default
-	-	-	-	RO	RO

[Table 12-1 on page 12-4](#) describes the condition codes.

Configurations The PMPIDR1 is in the Debug power domain.

Attributes See the register summary in [Table 12-15 on page 12-23](#).

[Figure 12-10](#) shows the PMPIDR1 bit assignments.

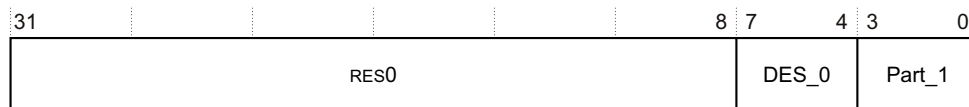

Figure 12-10 PMPIDR1 bit assignments

Table 12-19 shows the PMPIDR1 bit assignments.

Table 12-19 PMPIDR1 bit assignments

Bits	Name	Function
[31:8]	-	Reserved, RES0.
[7:4]	DES_0	0xB ARM Limited. This is the least significant nibble of JEP106 ID code.
[3:0]	Part_1	0x9 Most significant nibble of the performance monitor part number.

The PMPIDR1 can be accessed through the internal memory-mapped interface and the external debug interface, offset 0xFE4.

Peripheral Identification Register 2

The PMPIDR2 characteristics are:

Purpose Provides information to identify a Performance Monitor component.

Usage constraints The accessibility to the PMPIDR2 by condition code is:

Off	DLK	OSLK	EPAD	SLK	Default
-	-	-	-	RO	RO

Table 12-1 on page 12-4 describes the condition codes.

The PMPIDR2 can be accessed through the internal memory-mapped interface and the external debug interface.

Configurations The PMPIDR2 is in the Debug power domain.

Attributes See the register summary in Table 12-15 on page 12-23.

Figure 12-11 shows the PMPIDR2 bit assignments.

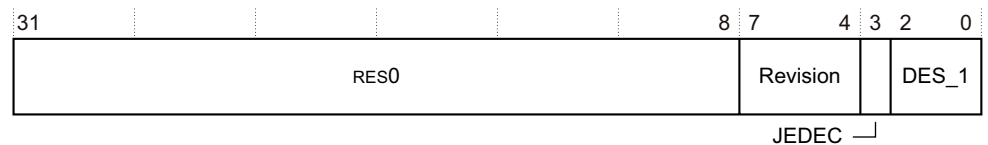

Figure 12-11 PMPIDR2 bit assignments

Table 12-20 shows the PMPIDR2 bit assignments.

Table 12-20 PMPIDR2 bit assignments

Bits	Name	Function
[31:8]	-	Reserved, RES0.
[7:4]	Revision	0x2 r0p2.
[3]	JEDEC	0b1 RAO. Indicates a JEP106 identity code is used.
[2:0]	DES_1	0b011 ARM Limited. This is the most significant nibble of JEP106 ID code.

The PMPIDR2 can be accessed through the internal memory-mapped interface and the external debug interface, offset 0xFE8.

Peripheral Identification Register 3

The PMPIDR3 characteristics are:

Purpose Provides information to identify a Performance Monitor component.

Usage constraints The PMPIDR3 can be accessed through the internal memory-mapped interface and the external debug interface.

The accessibility to the PMPIDR3 by condition code is:

Off	DLK	OSLK	EPMA	SLK	Default
-	-	-	-	RO	RO

[Table 12-1 on page 12-4](#) describes the condition codes.

Configurations The PMPIDR3 is in the Debug power domain.

Attributes See the register summary in [Table 12-15 on page 12-23](#).

[Figure 12-12](#) shows the PMPIDR3 bit assignments.

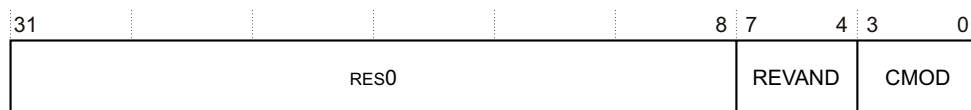

Figure 12-12 PMPIDR3 bit assignments

[Table 12-21](#) shows the PMPIDR3 bit assignments.

Table 12-21 PMPIDR3 bit assignments

Bits	Name	Function
[31:8]	-	Reserved, RES0.
[7:4]	REVAND	0x0 Part minor revision.
[3:0]	CMOD	0x0 Customer modified.

The PMPIDR3 can be accessed through the internal memory-mapped interface and the external debug interface, offset 0xFEC.

Peripheral Identification Register 4

The PMPIDR4 characteristics are:

Purpose Provides information to identify a Performance Monitor component.

Usage constraints The PMPIDR4 can be accessed through the internal memory-mapped interface and the external debug interface.

The accessibility to the PMPIDR4 by condition code is:

Off	DLK	OSLK	EPAD	SLK	Default
-	-	-	-	RO	RO

Table 12-1 on page 12-4 describes the condition codes.

Configurations The PMPIDR4 is in the Debug power domain.

Attributes See the register summary in Table 12-15 on page 12-23.

Figure 12-13 shows the PMPIDR4 bit assignments.

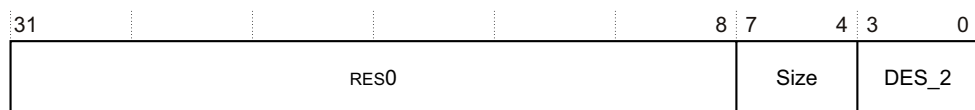

Figure 12-13 PMPIDR4 bit assignments

Table 12-22 shows the PMPIDR4 bit assignments.

Table 12-22 PMPIDR4 bit assignments

Bits	Name	Function
[31:8]	-	Reserved, RES0.
[7:4]	Size	0x0 Size of the component. Log2 the number of 4KB pages from the start of the component to the end of the component ID registers.
[3:0]	DES_2	0x4 ARM Limited. This is the least significant nibble JEP106 continuation code.

The PMPIDR4 can be accessed through the internal memory-mapped interface and the external debug interface, offset 0xFD0.

Peripheral Identification Register 5-7

No information is held in the Peripheral ID5, Peripheral ID6 and Peripheral ID7 Registers. They are reserved for future use and are RES0.

12.8.3 Component Identification Registers

There are four read-only Component Identification Registers, Component ID0 through Component ID3. Table 12-23 shows these registers.

Table 12-23 Summary of the Component Identification Registers

Register	Value	Offset
Component ID0	0x0D	0xFF0
Component ID1	0x90	0xFF4
Component ID2	0x05	0xFF8
Component ID3	0xB1	0xFFC

The Component Identification Registers identify Performance Monitor as ARM PMUv3 architecture. The Component ID registers are:

- [Component Identification Register 0](#).
- [Component Identification Register 1](#).
- [Component Identification Register 2 on page 12-33](#).
- [Component Identification Register 3 on page 12-34](#).

Component Identification Register 0

The PMCIDR0 characteristics are:

Purpose Provides information to identify a Performance Monitor component.

Usage constraints The PMCIDR0 can be accessed through the internal memory-mapped interface and the external debug interface.

The accessibility to the PMCIDR0 by condition code is:

Off	DLK	OSLK	EPMA	SLK	Default
-	-	-	-	RO	RO

[Table 12-1 on page 12-4](#) describes the condition codes.

Configurations The PMCIDR0 is in the Debug power domain.

Attributes See the register summary in [Table 12-15 on page 12-23](#).

[Figure 12-14](#) shows the PMCIDR0 bit assignments.

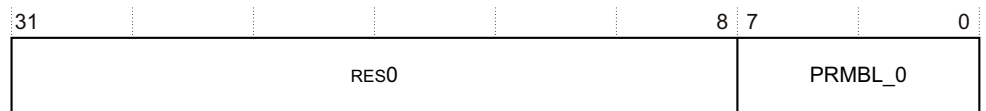

Figure 12-14 PMCIDR0 bit assignments

[Table 12-24](#) shows the PMCIDR0 bit assignments.

Table 12-24 PMCIDR0 bit assignments

Bits	Name	Function
[31:8]	-	Reserved, RES0.
[7:0]	Size	0x00 Preamble byte 0.

The PMCIDR0 can be accessed through the internal memory-mapped interface and the external debug interface, offset 0xFF0.

Component Identification Register 1

The PMCIDR1 characteristics are:

Purpose Provides information to identify a Performance Monitor component.

Usage constraints The PMCIDR1 can be accessed through the internal memory-mapped interface and the external debug interface.

The accessibility to the PMCIDR1 by condition code is:

Off	DLK	OSLK	EPAD	SLK	Default
-	-	-	-	RO	RO

Table 12-1 on page 12-4 describes the condition codes.

Configurations The PMCIDR1 is in the Debug power domain.

Attributes See the register summary in Table 12-15 on page 12-23.

Figure 12-15 shows the PMCIDR1 bit assignments.

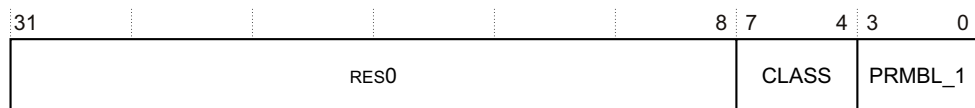

Figure 12-15 PMCIDR1 bit assignments

Table 12-25 shows the PMCIDR1 bit assignments.

Table 12-25 PMCIDR1 bit assignments

Bits	Name	Function
[31:8]	-	Reserved, RES0.
[7:4]	CLASS	0x9 Debug component.
[3:0]	PRMBL_1	0x0 Preamble byte 1.

The PMCIDR1 can be accessed through the internal memory-mapped interface and the external debug interface, offset 0xFF4.

Component Identification Register 2

The PMCIDR2 characteristics are:

Purpose Provides information to identify a Performance Monitor component.

Usage constraints The PMCIDR2 can be accessed through the internal memory-mapped interface and the external debug interface.

The accessibility to the PMCIDR2 by condition code is:

Off	DLK	OSLK	EPAD	SLK	Default
-	-	-	-	RO	RO

Table 12-1 on page 12-4 describes the condition codes.

Configurations The PMCIDR2 is in the Debug power domain.

Attributes See the register summary in Table 12-15 on page 12-23.

Figure 12-16 on page 12-34 shows the PMCIDR2 bit assignments.

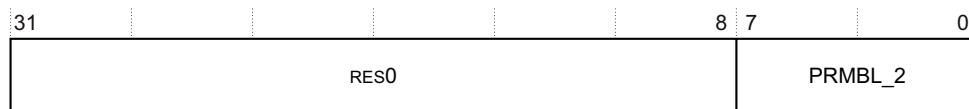

Figure 12-16 PMCIDR2 bit assignments

Table 12-26 shows the PMCIDR2 bit assignments.

Table 12-26 PMCIDR2 bit assignments

Bits	Name	Function
[31:8]	-	Reserved, RES0.
[7:0]	PRMBL_2	0x05 Preamble byte 2.

The PMCIDR2 can be accessed through the internal memory-mapped interface and the external debug interface, offset 0xFF8.

Component Identification Register 3

The PMCIDR3 characteristics are:

Purpose Provides information to identify a Performance Monitor component.

Usage constraints The PMCIDR3 can be accessed through the internal memory-mapped interface and the external debug interface.

The accessibility to the PMCIDR3 by condition code is:

Off	DLK	OSLK	EPAD	SLK	Default
-	-	-	-	RO	RO

Table 12-1 on page 12-4 describes the condition codes.

Configurations The PMCIDR3 is in the Debug power domain.

Attributes See the register summary in Table 12-15 on page 12-23.

Figure 12-17 shows the PMCIDR3 bit assignments.

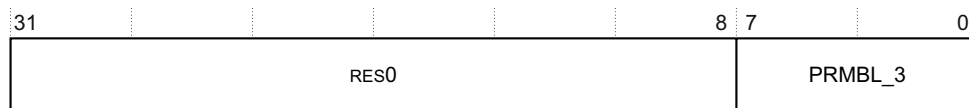

Figure 12-17 PMCIDR3 bit assignments

Table 12-27 shows the PMCIDR3 bit assignments.

Table 12-27 PMCIDR3 bit assignments

Bits	Name	Function
[31:8]	-	Reserved, RES0.
[7:0]	PRMBL_3	0xB1 Preamble byte 3.

The PMCIDR3 can be accessed through the internal memory-mapped interface and the external debug interface, offset 0xFFC.

12.9 Events

Table 12-28 shows the events that are generated and the numbers that the PMU uses to reference the events. The table also shows the bit position of each event on the event bus. Event reference numbers that are not listed are reserved.

Table 12-28 PMU events

Event number	Event mnemonic	PMU event bus (to external)	PMU event bus (to trace)	Event name
0x00	SW_INCR	-	-	Software increment. The register is incremented only on writes to the Software Increment Register.
0x01	L1I_CACHE_REFILL	[0]	[0]	L1 Instruction cache refill.
0x02	L1I_TLB_REFILL	[1]	[1]	L1 Instruction TLB refill.
0x03	L1D_CACHE_REFILL	[2]	[2]	L1 Data cache refill.
0x04	L1D_CACHE	[3]	[3]	L1 Data cache access.
0x05	L1D_TLB_REFILL	[4]	[4]	L1 Data TLB refill.
0x06	LD_RETIRED	[5]	[5]	Instruction architecturally executed, condition check pass - load.
0x07	ST_RETIRED	[6]	[6]	Instruction architecturally executed, condition check pass - store.
0x08	INST_RETIRED	[7]	[7]	Instruction architecturally executed.
0x09	EXC_TAKEN	[9]	[9]	Exception taken.
0x0A	EXC_RETURN	[10]	[10]	Exception return.
0x0B	CID_WRITE_RETIRED	[11]	[11]	Change to Context ID retired.
0x0C	PC_WRITE_RETIRED	[12]	[12]	Instruction architecturally executed, condition check pass - write to CONTEXTIDR.
0x0D	BR_IMMED_RETIRED	[13]	[13]	Instruction architecturally executed, condition check pass - software change of the PC.
0x0F	UNALIGNED_LDST_RETIRED	[14]	[14]	Instruction architecturally executed, condition check pass - procedure return.
0x10	BR_MIS_PRED	[15]	[15]	Mispredicted or not predicted branch speculatively executed.
0x11	CPU_CYCLES	-	-	Cycle.
0x12	BR_PRED	[16]	[16]	Predictable branch speculatively executed.
0x13	MEM_ACCESS	[17]	[17]	L1 Data cache access.
0x14	L1I_CACHE	[18]	[18]	L1 Instruction cache access.
0x15	L1D_CACHE_WB	[19]	[19]	L1 Data cache Write-Back.
0x16	L2D_CACHE	[20]	[20]	L2 Data cache access.

Table 12-28 PMU events (continued)

Event number	Event mnemonic	PMU event bus (to external)	PMU event bus (to trace)	Event name
0x17	L2D_CACHE_REFILL	[21]	[21]	L2 Data cache refill.
0x18	L2D_CACHE_WB	[22]	[22]	L2 Data cache Write-Back.
0x19	BUS_ACCESS	-	-	Bus access.
0x1A	MEMORY_ERROR	-	-	Local memory error.
0x1D	BUS_CYCLES	-	-	Bus cycle.
0x1E	CHAIN	-	-	Odd performance counter chain mode.
0x60	BUS_ACCESS_LD	-	-	Bus access - Read.
0x61	BUS_ACCESS_ST	-	-	Bus access - Write.
0x7A	BR_INDIRECT_SPEC	-	-	Branch speculatively executed - Indirect branch.
0x86	EXC_IRQ	-	-	Exception taken, IRQ.
0x87	EXC_FIQ	-	-	Exception taken, FIQ.
0xC0	-	-	-	External memory request.
0xC1	-	-	-	Non-cacheable external memory request.
0xC2	-	-	-	Linefill because of prefetch.
0xC3	-	-	-	Instruction Cache Throttle occurred.
0xC4	-	-	-	Entering read allocate mode.
0xC5	-	-	-	Read allocate mode.
0xC6	-	-	-	Pre-decode error.
0xC7	-	-	-	Data Write operation that stalls the pipeline because the store buffer is full.
0xC8	-	-	-	SCU Snooped data from another CPU for this CPU.
0xC9	-	-	-	Conditional branch executed.
0xCA	-	-	-	Indirect branch mispredicted.
0xCB	-	-	-	Indirect branch mispredicted because of address miscompare.
0xCC	-	-	-	Conditional branch mispredicted.
0xD0	-	[23]	[23]	L1 Instruction Cache (data or tag) memory error.
0xD1	-	[24]	[24]	L1 Data Cache (data, tag or dirty) memory error, correctable or non-correctable.
0xD2	-	[25]	[25]	TLB memory error.

Table 12-28 PMU events (continued)

Event number	Event mnemonic	PMU event bus (to external)	PMU event bus (to trace)	Event name
0xE0	-	-	-	Attributable Performance Impact Event. Counts every cycle that the DPU IQ is empty and that is not because of a recent micro-TLB miss, instruction cache miss or pre-decode error.
0xE1	-	-	-	Attributable Performance Impact Event. Counts every cycle the DPU IQ is empty and there is an instruction cache miss being processed.
0xE2	-	-	-	Attributable Performance Impact Event. Counts every cycle the DPU IQ is empty and there is an instruction micro-TLB miss being processed.
0xE3	-	-	-	Attributable Performance Impact Event. Counts every cycle the DPU IQ is empty and there is a pre-decode error being processed.
0xE4	-	-	-	Attributable Performance Impact Event. Counts every cycle there is an interlock that is not because of an Advanced SIMD or Floating-point instruction, and not because of a load/store instruction waiting for data to calculate the address in the AGU. Stall cycles because of a stall in Wr, typically awaiting load data, are excluded.
0xE5	-	-	-	Attributable Performance Impact Event. Counts every cycle there is an interlock that is because of a load/store instruction waiting for data to calculate the address in the AGU. Stall cycles because of a stall in Wr, typically awaiting load data, are excluded.
0xE6	-	-	-	Attributable Performance Impact Event. Counts every cycle there is an interlock that is because of an Advanced SIMD or Floating-point instruction. Stall cycles because of a stall in the Wr stage, typically awaiting load data, are excluded.
0xE7	-	-	-	Attributable Performance Impact Event Counts every cycle there is a stall in the Wr stage because of a load miss.

Table 12-28 PMU events (continued)

Event number	Event mnemonic	PMU event bus (to external)	PMU event bus (to trace)	Event name
0xE8	-	-	-	Attributable Performance Impact Event. Counts every cycle there is a stall in the Wr stage because of a store.
-	-	[8]	[8]	Two instructions architecturally executed. Counts every cycle in which two instructions are architecturally retired. Event 0x08, INTR_RETIRED, always counts when this event counts.
-	-	[26]	[26]	L2 (data or tag) memory error, correctable or non-correctable.
-	-	[27]	[27]	SCU snoop filter memory error, correctable or non-correctable.
-	-	[28]	-	Advanced SIMD and Floating-point retention active.
-	-	[29]	-	CPU retention active.

12.10 Interrupts

The Cortex-A53 processor asserts the **nPMUIRQ** signal when an interrupt is generated by the PMU. You can route this signal to an external interrupt controller for prioritization and masking. This is the only mechanism that signals this interrupt to the processor.

This interrupt is also driven as a trigger input to the CTI. See [Chapter 14 Cross Trigger](#) for more information.

12.11 Exporting PMU events

This section describes exporting of PMU events in:

- [External hardware](#).
- [Debug trace hardware](#).

12.11.1 External hardware

In addition to the counters in the processor, some of the events that [Table 12-28 on page 12-36](#) describes are exported on the **PMUEVENT** bus and can be connected to external hardware.

12.11.2 Debug trace hardware

Some of the events that [Table 12-28 on page 12-36](#) describes are exported to the ETM trace unit, or to the *Cross Trigger Interface (CTI)*, to enable the events to be monitored. See [Chapter 13 Embedded Trace Macrocell](#) and [Chapter 14 Cross Trigger](#) for more information.

Chapter 13

Embedded Trace Macrocell

This chapter describes the *Embedded Trace Macrocell* (ETM) for the Cortex-A53 processor. It contains the following sections:

- *About the ETM* on page 13-2.
- *ETM trace unit generation options and resources* on page 13-3.
- *ETM trace unit functional description* on page 13-5.
- *Reset* on page 13-7.
- *Modes of operation and execution* on page 13-8.
- *ETM trace unit register interfaces* on page 13-9.
- *ETM register summary* on page 13-10.
- *ETM register descriptions* on page 13-13.
- *Interaction with debug and performance monitoring unit* on page 13-76.

13.1 About the ETM

The ETM trace unit is a module that performs real-time instruction flow tracing based on the *Embedded Trace Macrocell* (ETM) architecture ETMv4. ETM is a CoreSight component, and is an integral part of the ARM Real-time Debug solution, DS-5 Development Studio. See the CoreSight documentation in [Additional reading on page ix](#) for more information.

13.2 ETM trace unit generation options and resources

Table 13-1 shows the trace generation options implemented in the Cortex-A53 ETM trace unit.

Table 13-1 ETM trace unit generation options implemented

Description	Configuration
Instruction address size in bytes	8
Data address size in bytes	0
Data value size in bytes	0
Virtual Machine ID size in bytes	1
Context ID size in bytes	4
Support for conditional instruction tracing	Not implemented
Support for tracing of data	Not implemented
Support for tracing of load and store instructions as P0 elements	Not implemented
Support for cycle counting in the instruction trace	Implemented
Support for branch broadcast tracing	Implemented
Exception Levels implemented in Non-secure state	EL2, EL1, EL0
Exception Levels implemented in Secure state	EL3, EL1, EL0
Number of events supported in the trace	4
Return stack support	Implemented
Tracing of SError exception support	Implemented
Instruction trace cycle counting minimum threshold	1
Size of Trace ID	7 bits
Synchronization period support	Read-write
Global timestamp size	64 bits
Number of cores available for tracing	1
ATB trigger support	Implemented
Low power behavior override	Implemented
Stall control support	Implemented
Support for no overflows in the trace	Not implemented

Table 13-2 shows the resources implemented in the Cortex-A53 ETM trace unit.

Table 13-2 ETM trace unit resources implemented

Description	Configuration
Number of resource selection pairs implemented	8
Number of external input selectors implemented	4
Number of external inputs implemented	30, 4 CTI + 26 PMU
Number of counters implemented	2
Reduced function counter implemented	Not implemented
Number of sequencer states implemented	4
Number of Virtual Machine ID comparators implemented	1
Number of Context ID comparators implemented	1
Number of address comparator pairs implemented	4
Number of single-shot comparator controls	1
Number of processor comparator inputs implemented	0
Data address comparisons implemented	Not implemented
Number of data value comparators implemented	0

13.3 ETM trace unit functional description

This section describes the ETM trace unit. It contains the following sections:

- *Processor interface.*
- *Trace generation.*
- *Filtering and triggering resources.*
- *FIFO.*
- *Trace out on page 13-6.*
- *Syncbridge on page 13-6.*

Figure 13-1 shows the main functional blocks of the ETM trace unit.

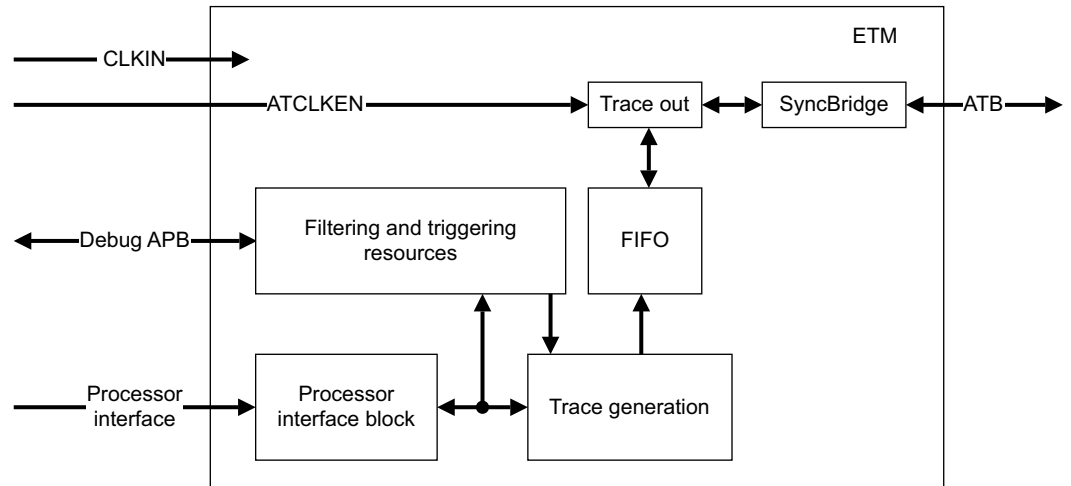

Figure 13-1 ETM functional blocks

13.3.1 Processor interface

This block monitors the behavior of the processor and generates P0 elements that are essentially executed instructions and exceptions traced in program order.

13.3.2 Trace generation

The trace generation block generates various trace packets based on P0 elements.

13.3.3 Filtering and triggering resources

You can limit the amount of trace data generated by the ETM, through the process of filtering. For example, generating trace only in a certain address range. More complicated logic analyzer style filtering options are also available.

The ETM trace unit can also generate a trigger that is a signal to the trace capture device to stop capturing trace.

13.3.4 FIFO

The trace generated by the ETM trace unit is in a highly-compressed form. The FIFO enables trace bursts to be flattened out. When the FIFO becomes full, the FIFO signals an overflow. The trace generation logic does not generate any new trace until the FIFO is emptied. This causes a gap in the trace when viewed in the debugger.

13.3.5 Trace out

Trace from FIFO is output on the synchronous AMBA ATB interface.

13.3.6 Syncbridge

The ATB interface from the trace out block goes through an ATB synchronous bridge.

13.4 Reset

The reset for ETM trace unit is the same as a cold reset for the processor. The ETM trace unit is not reset when warm reset is applied to the processor so that tracing through warm processor reset is possible.

If the ETM trace unit is reset, tracing stops until the ETM trace unit is reprogrammed and re-enabled. However, if the processor is reset using warm reset, the last few instructions provided by the processor before the reset might not be traced.

13.5 Modes of operation and execution

The following sections describes how to control ETM trace unit programming.

13.5.1 Controlling ETM trace unit programming

When programming the ETM trace unit registers, you must enable all the changes at the same time. For example, if the counter is reprogrammed, it might start to count based on incorrect events, before the trigger condition has been correctly set up.

You must use the ETM trace unit main enable in the TRCPRGCTLR to disable all trace operations during programming. See [Programming Control Register on page 13-13](#). [Figure 13-2](#) shows the procedure to follow.

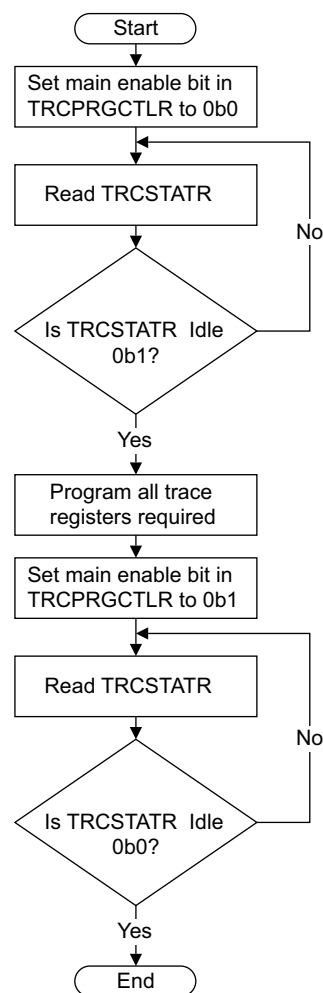

Figure 13-2 Programming ETM trace unit registers

The Cortex-A53 processor does not have to be in the debug state while you program the ETM trace unit registers.

13.5.2 Programming and reading ETM trace unit registers

You program and read the ETM trace unit registers using the Debug APB interface. This provides a direct method of programming the ETM trace unit.

13.6 ETM trace unit register interfaces

The Cortex-A53 processor supports only memory-mapped interface to trace registers. For more information see [External debug interface on page 11-37](#).

13.6.1 Access permissions

See the *ARM® ETM™ Architecture Specification, ETMv4* for information on the behaviors on register accesses for different trace unit states and the different access mechanisms.

13.7 ETM register summary

This section summarizes the ETM trace unit registers. For full descriptions of the ETM trace unit registers, see:

- [ETM register descriptions on page 13-13](#), for the IMPLEMENTATION DEFINED registers and the ARM® ETM™ Architecture Specification, ETMv4, for the other registers.

———— **Note** —————

In [Table 13-3](#), access type is described as follows:

RW	Read and write.
RO	Read only.
WO	Write only.

[Table 13-3](#) lists all of the ETM trace unit registers.

All ETM trace unit registers are 32 bits wide. The description of each register includes its offset from a base address. The base address is defined by the system integrator when placing the ETM trace unit in the Debug-APB memory map.

Table 13-3 ETM trace unit register summary

Name	Type	Description
-	-	Reserved
TRCPRGCTLR	RW	Programming Control Register on page 13-13
TRCSTATR	RO	Status Register on page 13-13
TRCCONFIGR	RW	Trace Configuration Register on page 13-14
TRCAUXCTLR	RW	Auxiliary Control Register on page 13-16
TRCEVENTCTL0R	RW	Event Control 0 Register on page 13-18
TRCEVENTCTL1R	RW	Event Control 1 Register on page 13-19
TRCSTALLCTLR	RW	Stall Control Register on page 13-20
TRCTSCTLR	RW	Global Timestamp Control Register on page 13-21
TRCSYNCPR	RW	Synchronization Period Register on page 13-22
TRCCCCTLR	RW	Cycle Count Control Register on page 13-23
TRCBBCTLR	RW	Branch Broadcast Control Register on page 13-15
TRCTRACEIDR	RW	Trace ID Register on page 13-23
TRCVICTLR	RW	ViewInst Main Control Register on page 13-24
TRCVIIECTLR	RW	ViewInst Include-Exclude Control Register on page 13-26
TRCVISSCTLR	RW	ViewInst Start-Stop Control Register on page 13-27
TRCSEQEVR0	RW	Sequencer State Transition Control Registers 0-2 on page 13-27
TRCSEQEVR1	RW	Sequencer State Transition Control Registers 0-2 on page 13-27
TRCSEQEVR2	RW	Sequencer State Transition Control Registers 0-2 on page 13-27
TRCSEQRSTEV	RW	Sequencer Reset Control Register on page 13-28

Table 13-3 ETM trace unit register summary (continued)

Name	Type	Description
TRCSEQSTR	RW	<i>Sequencer State Register on page 13-29</i>
TRCEXTINSELR	RW	<i>External Input Select Register on page 13-30</i>
TRCCNTRLDVR0	RW	<i>Counter Reload Value Registers 0-1 on page 13-31</i>
TRCCNTRLDVR1	RW	<i>Counter Reload Value Registers 0-1 on page 13-31</i>
TRCCNTCTLR0	RW	<i>Counter Control Register 0 on page 13-31</i>
TRCCNTCTLR1	RW	<i>Counter Control Register 1 on page 13-32</i>
TRCCNTVR0	RW	<i>Counter Value Registers 0-1 on page 13-33</i>
TRCCNTVR1	RW	<i>Counter Value Registers 0-1 on page 13-33</i>
TRCIDR8	RO	<i>ID Register 8 on page 13-34</i>
TRCIDR9	RO	<i>ID Register 9 on page 13-35</i>
TRCIDR10	RO	<i>ID Register 10 on page 13-35</i>
TRCIDR11	RO	<i>ID Register 11 on page 13-36</i>
TRCIDR12	RO	<i>ID Register 12 on page 13-36</i>
TRCIDR13	RO	<i>ID Register 13 on page 13-37</i>
TCRIMSPEC0	RW	<i>Implementation Specific Register 0 on page 13-38</i>
TRCIDR0	RO	<i>ID Register 0 on page 13-38</i>
TRCIDR1	RO	<i>ID Register 1 on page 13-40</i>
TRCIDR2	RO	<i>ID Register 2 on page 13-40</i>
TRCIDR3	RO	<i>ID Register 3 on page 13-41</i>
TRCIDR4	RO	<i>ID Register 4 on page 13-43</i>
TRCIDR5	RO	<i>ID Register 5 on page 13-44</i>
TRCRSCTLRn	RW	<i>Resource Selection Control Registers 2-16 on page 13-45, n is 2, 15</i>
TRCSSCCR0	RW	<i>Single-Shot Comparator Control Register 0 on page 13-46</i>
TRCSSCSR0	RW, RO	<i>Single-Shot Comparator Status Register 0 on page 13-47</i>
TRCOSLAR	WO	<i>OS Lock Access Register on page 13-48</i>
TRCOSLSR	RO	<i>OS Lock Status Register on page 13-48</i>
TRCPDCR	RW	<i>Power Down Control Register on page 13-49</i>
TRCPDSR	RO	<i>Power Down Status Register on page 13-50</i>
TRCACVRn	RW	<i>Address Comparator Value Registers 0-7 on page 13-51</i>
TRCACATRn	RW	<i>Address Comparator Access Type Registers 0-7 on page 13-52</i>
TRCCIDCVR0	RW	<i>Context ID Comparator Value Register 0 on page 13-54</i>
TRCVMICV0	RW	<i>VMID Comparator Value Register 0 on page 13-54</i>
TRCCIDCCTLR0	RW	<i>Context ID Comparator Control Register 0 on page 13-55</i>

Table 13-3 ETM trace unit register summary (continued)

Name	Type	Description
TRCITATBIDR	RW	<i>Integration ATB Identification Register on page 13-56</i>
TRCITIDATAR	WO	<i>Integration Instruction ATB Data Register on page 13-56</i>
TRCITIATBINR	RO	<i>Integration Instruction ATB In Register on page 13-58</i>
TRCITIATBOUTr	WO	<i>Integration Instruction ATB Out Register on page 13-59</i>
TRCITCTRL	RW	<i>Integration Mode Control Register on page 13-59</i>
TRCCLAIMSET	RW	<i>Claim Tag Set Register on page 13-60</i>
TRCCLAIMCLR	RW	<i>Claim Tag Clear Register on page 13-61</i>
TRCDEVAFF0	RO	<i>Device Affinity Register 0 on page 13-62</i>
TRCDEVAFF1	RO	<i>Device Affinity Register 1 on page 13-63</i>
TRCLAR	WO	<i>Software Lock Access Register on page 13-64</i>
TRCLSR	RO	<i>Software Lock Status Register on page 13-64</i>
TRCAUTHSTATUS	RO	<i>Authentication Status Register on page 13-65</i>
TRCDEVARCH	RO	<i>Device Architecture Register on page 13-66</i>
TRCDEVID	RO	<i>Device ID Register on page 13-67</i>
TRCDEVTYPE	RO	<i>Device Type Register on page 13-67</i>
TRCPIDR4	RO	<i>Peripheral Identification Register 4 on page 13-71</i>
TRCPIDR5	RO	<i>Peripheral Identification Register 5-7 on page 13-72</i>
TRCPIDR6	RO	
TRCPIDR7	RO	
TRCPIDR0	RO	<i>Peripheral Identification Register 0 on page 13-69</i>
TRCPIDR1	RO	<i>Peripheral Identification Register 1 on page 13-69</i>
TRCPIDR2	RO	<i>Peripheral Identification Register 2 on page 13-70</i>
TRCPIDR3	RO	<i>Peripheral Identification Register 3 on page 13-71</i>
TRCCIDR0	RO	<i>Component Identification Register 0 on page 13-72</i>
TRCCIDR1	RO	<i>Component Identification Register 1 on page 13-73</i>
TRCCIDR2	RO	<i>Component Identification Register 2 on page 13-74</i>
TRCCIDR3	RO	<i>Component Identification Register 3 on page 13-74</i>

13.8 ETM register descriptions

This section describes the implementation-specific ETM trace unit registers in the Cortex-A53 processor. [Table 13-3 on page 13-10](#) provides cross-references to individual registers.

The *ARM® ETM™ Architecture Specification, ETMv4* describes the other ETM trace unit registers.

13.8.1 Programming Control Register

The TRCPRGCTLR characteristics are:

- Purpose** Enables the ETM trace unit.
- Usage constraints** See [Controlling ETM trace unit programming on page 13-8](#).
- Configurations** Available in all configurations.
- Attributes** See the register summary in [Table 13-3 on page 13-10](#).

[Figure 13-3](#) shows the TRCPRGCTLR bit assignments.

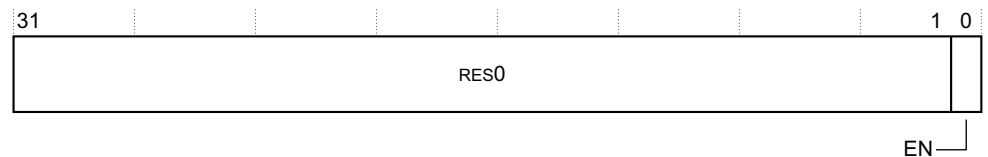

Figure 13-3 TRCPRGCTLR bit assignments

[Table 13-4](#) shows the TRCPRGCTLR bit assignments.

Table 13-4 TRCPRGCTLR bit assignments

Bits	Name	Function
[31:1]	-	Reserved, RES0.
[0]	EN	Trace program enable: <ul style="list-style-type: none"> 0 The ETM trace unit interface in the processor is disabled, and clocks are enabled only when necessary to process APB accesses, or drain any already generated trace. This is the reset value. 1 The ETM trace unit interface in the processor is enabled, and clocks are enabled. Writes to most trace registers are ignored

The TRCPRGCTLR can be accessed through the internal memory-mapped interface and the external debug interface, offset 0x004.

13.8.2 Status Register

The TRCSTATR characteristics are:

- Purpose** Indicates the ETM trace unit status.
- Usage constraints** There are no usage constraints.
- Configurations** Available in all configurations.
- Attributes** See the register summary in [Table 13-3 on page 13-10](#).

[Figure 13-4 on page 13-14](#) shows the TRCSTATR bit assignments.

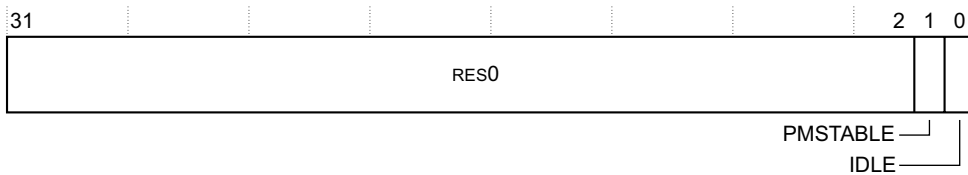

Figure 13-4 TRCSTATR bit assignments

Table 13-5 shows the TRCSTATR bit assignments.

Table 13-5 TRCSTATR bit assignments

Bits	Name	Function
[31:2]	-	Reserved, RES0.
[1]	PMSTABLE	Indicates whether the ETM trace unit registers are stable and can be read: 0 The programmers model is not stable. 1 The programmers model is stable.
[0]	IDLE	Idle status: 0 The ETM trace unit is not idle. 1 The ETM trace unit is idle.

The TRCSTATR can be accessed through the internal memory-mapped interface and the external debug interface, offset 0x00C.

13.8.3 Trace Configuration Register

The TRCCONFIGR characteristics are:

- Purpose** Controls the tracing options.
- Usage constraints**
 - This register must always be programmed as part of trace unit initialization.
 - Only accepts writes when the trace unit is disabled.
- Configurations** Available in all configurations.
- Attributes** TRCCONFIGR is a 32-bit RW trace register.
See the register summary in [Table 13-3 on page 13-10](#).

Figure 13-5 shows the TRCCONFIGR bit assignments.

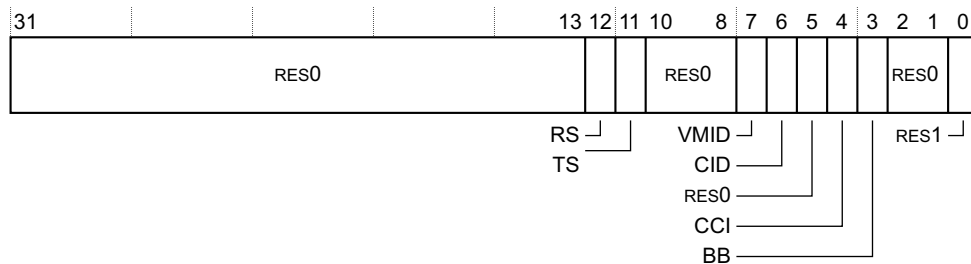

Figure 13-5 TRCCONFIGR bit assignments

Table 13-6 shows the TRCCONFIGR bit assignments.

Table 13-6 TRCCONFIGR bit assignments

Bits	Name	Function
[31:13]	-	Reserved, RES0.
[12]	RS	Enables the return stack. The possible values are: 0 Disables the return stack. 1 Enables the return stack.
[11]	TS	Enables global timestamp tracing. The possible values are: 0 Disables global timestamp tracing. 1 Enables global timestamp tracing.
[10:8]	-	Reserved, RES0.
[7]	VMID	Enables VMID tracing. The possible values are: 0 Disables VMID tracing. 1 Enables VMID tracing.
[6]	CID	Enables context ID tracing. The possible values are: 0 Disables context ID tracing. 1 Enables context ID tracing.
[5]	-	Reserved, RES0.
[4]	CCI	Enables cycle counting instruction trace. The possible values are: 0 Disables cycle counting instruction trace. 1 Enables cycle counting instruction trace.
[3]	BB	Enables branch broadcast mode. The possible values are: 0 Disables branch broadcast mode. 1 Enables branch broadcast mode.
[2:1]	-	Reserved, RES0.
[0]	-	Reserved, RES1.

The TRCCONFIGR can be accessed through the internal memory-mapped interface and the external debug interface, offset 0x010.

13.8.4 Branch Broadcast Control Register

The TRCBBCTLR characteristics are:

Purpose	Controls how branch broadcasting behaves, and enables branch broadcasting to be enabled for certain memory regions.
Usage constraints	<ul style="list-style-type: none"> • Only accepts writes when the trace unit is disabled. • Must be programmed if TRCCONFIGR.BB == 1.
Configurations	Available in all configurations.
Attributes	See the register summary in Table 13-3 on page 13-10 .

[Figure 13-6 on page 13-16](#) shows the TRCBBCTLR bit assignments.

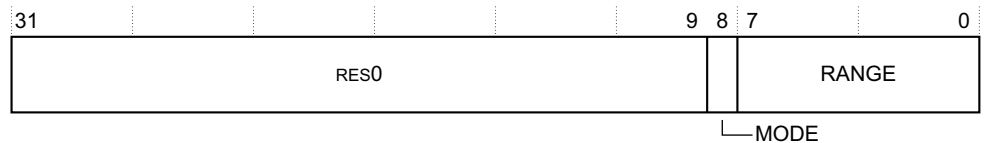

Figure 13-6 TRCBBCTLR bit assignments

Table 13-7 shows the TRCBBCTLR bit assignments.

Table 13-7 TRCBBCTLR bit assignments

Bits	Name	Function
[31:9]	-	Reserved, RES0.
[8]	MODE	Mode bit: 0 Exclude mode. Branch broadcasting is not enabled in the address range that RANGE defines. If RANGE==0 then branch broadcasting is enabled for the entire memory map. 1 Include mode. Branch broadcasting is enabled in the address range that RANGE defines. If RANGE==0 then the behavior of the trace unit is constrained UNPREDICTABLE. That is, the trace unit might or might not consider any instructions to be in a branch broadcast region.
[7:0]	RANGE	Address range field. Selects which address range comparator pairs are in use with branch broadcasting. Each bit represents an address range comparator pair, so bit[n] controls the selection of address range comparator pair n. If bit[n] is: 0 The address range that address range comparator pair n defines, is not selected. 1 The address range that address range comparator pair n defines, is selected.

The TRCBBCTLR can be accessed through the internal memory-mapped interface and the external debug interface, offset 0x03C.

13.8.5 Auxiliary Control Register

The TRCAUXCTLR characteristics are:

Purpose The function of this register is to provide IMPLEMENTATION DEFINED configuration and control options.

Usage constraints There are no usage constraints.

Configurations Available in all configurations.

Attributes See the register summary in [Table 13-3 on page 13-10](#).

[Figure 13-7 on page 13-17](#) shows the TRCAUXCTLR bit assignments.

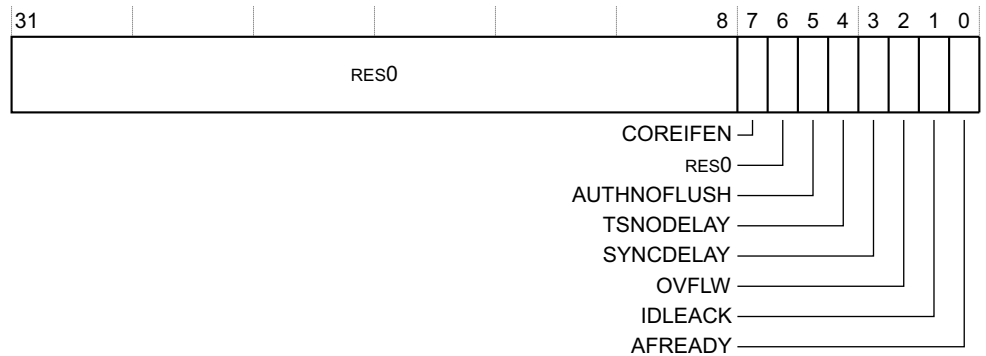

Figure 13-7 TRCAUXCTLR bit assignments

Table 13-8 shows the TRCAUXCTLR bit assignments.

Table 13-8 TRCAUXCTLR bit assignments

Bits	Name	Function
[31:8]	-	Reserved, RES0.
[7]	COREIFEN	Keep core interface enabled regardless of trace enable register state. The possible values are: 0 Core interface enabled is set by trace enable register state. 1 Enable core interface, regardless of trace enable register state.
[6]	-	Reserved, RES0.
[5]	AUTHNOFLUSH	Do not flush trace on de-assertion of authentication inputs. The possible values are: 0 ETM trace unit FIFO is flushed and ETM trace unit enters idle state when DBGEN or NIDEN is LOW. 1 ETM trace unit FIFO is not flushed and ETM trace unit does not enter idle state when DBGEN or NIDEN is LOW. When this bit is set to 1, the trace unit behavior deviates from architecturally-specified behavior.
[4]	TSNODELAY	Do not delay timestamp insertion based on FIFO depth. The possible values are: 0 Timestamp packets are inserted into FIFO only when trace activity is LOW. 1 Timestamp packets are inserted into FIFO irrespective of trace activity.
[3]	SYNCDELAY	Delay periodic synchronization if FIFO is more than half-full. The possible values are: 0 SYNC packets are inserted into FIFO only when trace activity is low. 1 SYNC packets are inserted into FIFO irrespective of trace activity.

Table 13-8 TRCAUXCTLR bit assignments (continued)

Bits	Name	Function
[2]	OVFLW	Force an overflow if synchronization is not completed when second synchronization becomes due. The possible values are: 0 No FIFO overflow when SYNC packets are delayed. 1 Forces FIFO overflow when SYNC packets are delayed. When this bit is set to 1, the trace unit behavior deviates from architecturally-specified behavior.
[1]	IDLEACK	Force idle-drain acknowledge high, CPU does not wait for trace to drain before entering WFX state. The possible values are: 0 ETM trace unit idle acknowledge is asserted only when the ETM trace unit is in idle state. 1 ETM trace unit idle acknowledge is asserted irrespective of the ETM trace unit idle state. When this bit is set to 1, trace unit behavior deviates from architecturally-specified behavior.
[0]	AFREADY	Always respond to AFREADY immediately. Does not have any interaction with FIFO draining, even in WFI state. The possible values are: 0 ETM trace unit AFREADYM output is asserted only when the ETM trace unit is in idle state or when all the trace bytes in FIFO before a flush request are output. 1 ETM trace unit AFREADYM output is always asserted HIGH. When this bit is set to 1, trace unit behavior deviates from architecturally-specified behavior.

The TRCAUXCTLR can be accessed through the internal memory-mapped interface and the external debug interface, offset 0x018.

13.8.6 Event Control 0 Register

The TRCEVENTCTL0R characteristics are:

- Purpose** Controls the tracing of events in the trace stream. The events also drive the external outputs from the ETM trace unit. The events are selected from the Resource Selectors.
- Usage constraints**
 - You must always program this register as part of trace unit initialization.
 - Accepts writes only when the trace unit is disabled.
- Configurations** Available in all configurations.
- Attributes** See the register summary in [Table 13-3 on page 13-10](#).

[Figure 13-8](#) shows the TRCEVENTCTL0R bit assignments.

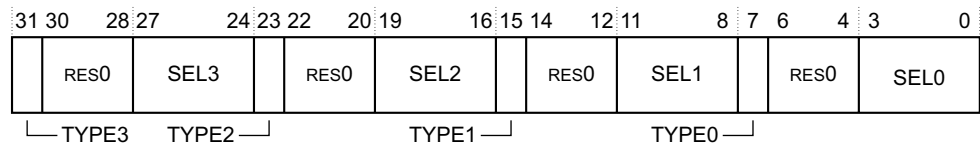

Figure 13-8 TRCEVENTCTL0R bit assignments

Table 13-9 shows the TRCEVENTCTL0R bit assignments.

Table 13-9 TRCEVENTCTL0R bit assignments

Bits	Name	Function
[31]	TYPE3	Selects the resource type for trace event 3: 0 Single selected resource. 1 Boolean combined resource pair.
[30:28]	-	Reserved, RES0.
[27:24]	SEL3	Selects the resource number, based on the value of TYPE3: When TYPE3 is 0, selects a single selected resource from 0-15 defined by bits[3:0]. When TYPE3 is 1, selects a Boolean combined resource pair from 0-7 defined by bits[2:0].
[23]	TYPE2	Selects the resource type for trace event 2: 0 Single selected resource. 1 Boolean combined resource pair.
[22:20]	-	Reserved, RES0.
[19:16]	SEL2	Selects the resource number, based on the value of TYPE2: When TYPE2 is 0, selects a single selected resource from 0-15 defined by bits[3:0]. When TYPE2 is 1, selects a Boolean combined resource pair from 0-7 defined by bits[2:0].
[15]	TYPE1	Selects the resource type for trace event 1: 0 Single selected resource. 1 Boolean combined resource pair.
[14:12]	-	Reserved, RES0.
[11:8]	SEL1	Selects the resource number, based on the value of TYPE1: When TYPE1 is 0, selects a single selected resource from 0-15 defined by bits[3:0]. When TYPE1 is 1, selects a Boolean combined resource pair from 0-7 defined by bits[2:0].
[7]	TYPE0	Selects the resource type for trace event 0: 0 Single selected resource. 1 Boolean combined resource pair.
[6:4]	-	Reserved, RES0.
[3:0]	SEL0	Selects the resource number, based on the value of TYPE0: When TYPE0 is 0, selects a single selected resource from 0-15 defined by bits[3:0]. When TYPE0 is 1, selects a Boolean combined resource pair from 0-7 defined by bits[2:0].

The TRCEVENTCTL0R can be accessed through the internal memory-mapped interface and the external debug interface, offset 0x020.

13.8.7 Event Control 1 Register

The TRCEVENTCTL1R characteristics are:

Purpose	Controls the behavior of the events that TRCEVENTCTL0R selects
Usage constraints	<ul style="list-style-type: none"> You must always program this register as part of trace unit initialization. Accepts writes only when the trace unit is disabled.
Configurations	Available in all configurations.

Attributes TRCEVENTCTL1R is a 32-bit RW trace register.
See the register summary in [Table 13-3 on page 13-10](#).

[Figure 13-9](#) shows the TRCEVENTCTL1R bit assignments.

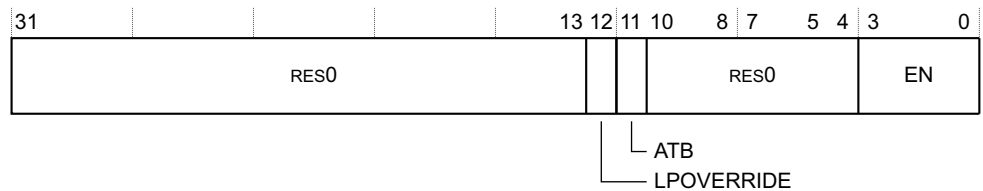

Figure 13-9 TRCEVENTCTL1R bit assignments

[Table 13-10](#) shows the TRCEVENTCTL1R bit assignments.

Table 13-10 TRCEVENTCTL1R bit assignments

Bits	Name	Function
[31:13]	-	Reserved, RES0.
[12]	LPOVERRIDE	Low power state behavior override: 0 Low power state behavior unaffected. 1 Low power state behavior overridden. The resources and Event trace generation are unaffected by entry to a low power state.
[11]	ATB	ATB trigger enable: 0 ATB trigger disabled. 1 ATB trigger enabled.
[10:4]	-	Reserved, RES0.
[3:0]	EN	One bit per event, to enable generation of an event element in the instruction trace stream when the selected event occurs: 0 Event does not cause an event element. 1 Event causes an event element.

The TRCEVENTCTL1R can be accessed through the internal memory-mapped interface and the external debug interface, offset 0x024.

13.8.8 Stall Control Register

The TRCSTALLCTLR characteristics are:

Purpose Enables the ETM trace unit to stall the Cortex-A53 processor if the ETM trace unit FIFO overflows.

Usage constraints

- You must always program this register as part of trace unit initialization.
- Accepts writes only when the trace unit is disabled.

Configurations Available in all configurations.

Attributes See the register summary in [Table 13-3 on page 13-10](#).

[Figure 13-10 on page 13-21](#) shows the TRCSTALLCTLR bit assignments.

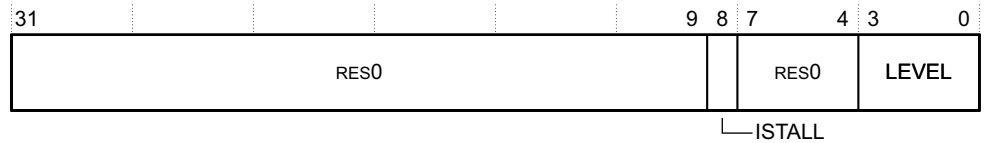

Figure 13-10 TRCSTALLCTLR bit assignments

Table 13-11 shows the TRCSTALLCTLR bit assignments.

Table 13-11 TRCSTALLCTLR bit assignments

Bits	Name	Function
[31:9]	-	Reserved, RES0.
[8]	ISTALL	Instruction stall bit. Controls if the trace unit can stall the processor when the instruction trace buffer space is less than LEVEL: 0 The trace unit does not stall the processor. 1 The trace unit can stall the processor.
[7:4]	-	Reserved, RES0.
[3:2]	LEVEL	Threshold level field. The field can support 4 monotonic levels from 0b00 to 0b11, where: 0b00 Zero invasion. This setting has a greater risk of an ETM trace unit FIFO overflow. 0b11 Maximum invasion occurs but there is less risk of a FIFO overflow.
[1:0]	-	Reserved, RES0.

The TRCSTALLCTLR can be accessed through the internal memory-mapped interface and the external debug interface, offset 0x02c.

13.8.9 Global Timestamp Control Register

The TRCTSCTLR characteristics are:

Purpose Controls the insertion of global timestamps in the trace streams. When the selected event is triggered, the trace unit inserts a global timestamp into the trace streams. The event is selected from one of the Resource Selectors.

Usage constraints

- Accepts writes only when the trace unit is disabled.
- Must be programmed if TRCCONFIGR.TS==1.

Configurations Available in all configurations.

Attributes TRCTSCTLR is a 32-bit RW trace register.
The register is set to an UNKNOWN value on a trace unit reset. See also [Table 13-3 on page 13-10](#).

Figure 13-11 shows the TRCTSCTLR bit assignments:

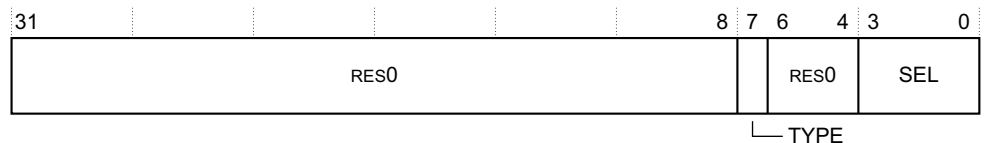

Figure 13-11 TRCTSCTLR bit assignments

Table 13-12 shows the TRCTSCTLR bit assignments:

Table 13-12 TRCTSCTLR bit assignments

Bits	Name	Function
[31:8]	-	Reserved, RES0
[7]	TYPE	Single or combined resource selector
[6:4]	-	Reserved
[3:1]	SEL	Identifies the resource selector to use

The TRCTSCTLR can be accessed through the internal memory-mapped interface and the external debug interface, offset 0x030.

13.8.10 Synchronization Period Register

The TRCSYNCPD characteristics are:

Purpose Controls how often periodic trace synchronization requests occur.

Usage constraints

- You must always program this register as part of trace unit initialization.
- Accepts writes only when the trace unit is disabled.

Configurations Available in all configurations.

Attributes See the register summary in [Table 13-3 on page 13-10](#).

[Figure 13-12](#) shows the TRCSYNCPD bit assignments.

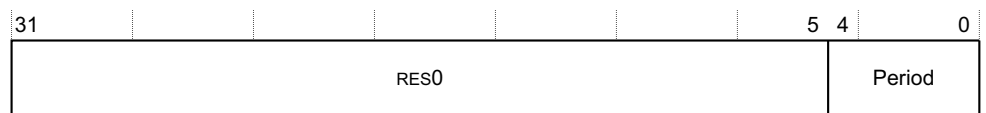

Figure 13-12 TRCSYNCPD bit assignments

[Table 13-13](#) shows the TRCSYNCPD bit assignments.

Table 13-13 TRCSYNCPD bit assignments

Bits	Name	Function
[31:5]	-	Reserved, RES0.
[4:0]	PERIOD	<p>Defines the number of bytes of trace between synchronization requests as a total of the number of bytes generated by both the instruction and data streams. The number of bytes is 2^N where N is the value of this field:</p> <ul style="list-style-type: none"> A value of zero disables these periodic synchronization requests, but does not disable other synchronization requests. The minimum value that can be programmed, other than zero, is 8, providing a minimum synchronization period of 256 bytes. The maximum value is 20, providing a maximum synchronization period of 2^{20} bytes.

The TRCSYNCPD can be accessed through the internal memory-mapped interface and the external debug interface, offset 0x034.

13.8.11 Cycle Count Control Register

The TRCCCCTLR characteristics are:

- Purpose** Sets the threshold value for cycle counting.
- Usage constraints**
 - Accepts writes only when the trace unit is disabled.
 - Must be programmed if TRCCONFIGR.CCI==1.
 - Minimum value that can be programmed is defined in TRCIDR3.CCITMIN.
- Configurations** Available in all configurations.
- Attributes** See the register summary in [Table 13-3 on page 13-10](#).

Figure 13-13 shows the TRCCCCTLR bit assignments.

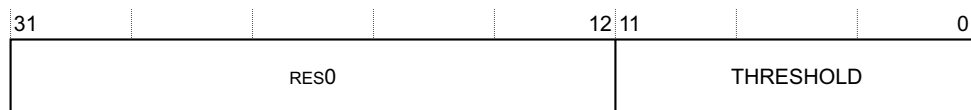

Figure 13-13 TRCCCCTLR bit assignments

Table 13-14 shows the TRCCCCTLR bit assignments.

Table 13-14 TRCCCCTLR bit assignments

Bits	Name	Function
[31:12]	-	Reserved, RES0.
[11:0]	THRESHOLD	Instruction trace cycle count threshold.

The TRCCCCTLR can be accessed through the internal memory-mapped interface and the external debug interface, offset 0x038.

13.8.12 Trace ID Register

The TRCTRACEIDR characteristics are:

- Purpose** Sets the trace ID for instruction trace.
- Usage constraints**
 - You must always program this register as part of trace unit initialization.
 - Accepts writes only when the trace unit is disabled.
- Configurations** Available in all configurations.
- Attributes** TRCTRACEIDR is a 32-bit RW trace register. See the register summary in [Table 13-3 on page 13-10](#).

Figure 13-14 shows the TRCTRACEIDR bit assignments.



Figure 13-14 TRCTRACEIDR bit Assignments

Table 13-15 shows the TRCTRACEIDR bit assignments.

Table 13-15 TRCTRACEIDR bit assignments

Bits	Name	Function
[31:7]	-	Reserved, RES0.
[6:0]	TRACEID	Trace ID value. When only instruction tracing is enabled, this provides the trace ID.

The TRCTRACEIDR can be accessed through the internal memory-mapped interface and the external debug interface, offset 0x040.

13.8.13 ViewInst Main Control Register

The TRCVICTLR characteristics are:

- Purpose** Controls instruction trace filtering.
- Usage constraints**
 - Accepts writes only when the trace unit is disabled.
 - Returns stable data only when TRCSTATR.PMSTABLE==1.
 - Must be programmed, particularly to set the value of the SSSTATUS bit, that sets the state of the start-stop logic.
- Configurations** Available in all configurations.
- Attributes** See the register summary in Table 13-3 on page 13-10.

Figure 13-15 shows the TRCVICTLR bit assignments.

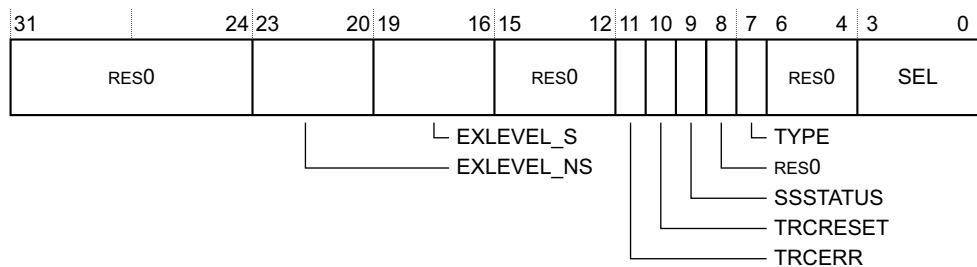

Figure 13-15 TRCVICTLR bit assignments

Table 13-16 shows the TRCVICTLR bit assignments.

Table 13-16 TRCVICTLR bit assignments

Bits	Name	Function
[31:24]	-	Reserved, RES0.
[23:20]	EXLEVEL_NS	In Non-secure state, each bit controls whether instruction tracing is enabled for the corresponding exception level: 0 Trace unit generates instruction trace, in Non-secure state, for exception level <i>n</i> . 1 Trace unit does not generate instruction trace, in Non-secure state, for exception level <i>n</i> . <hr/> <p style="text-align: center;">Note</p> The exception levels are: Bit[20] Exception level 0. Bit[21] Exception level 1. Bit[22] Exception level 2. Bit[23] RAZ/WI. Instruction tracing is not implemented for exception level 3.
[19:16]	EXLEVEL_S	In Secure state, each bit controls whether instruction tracing is enabled for the corresponding exception level: 0 Trace unit generates instruction trace, in Secure state, for exception level <i>n</i> . 1 Trace unit does not generate instruction trace, in Secure state, for exception level <i>n</i> . <hr/> <p style="text-align: center;">Note</p> The exception levels are: Bit[16] Exception level 0. Bit[17] Exception level 1. Bit[18] RAZ/WI. Instruction tracing is not implemented for exception level 2. Bit[19] Exception level 3.
[15:12]	-	Reserved, RES0.
[11]	TRCERR	Selects whether a system error exception must always be traced: 0 System error exception is traced only if the instruction or exception immediately before the system error exception is traced. 1 System error exception is always traced regardless of the value of ViewInst.
[10]	TRCRESET	Selects whether a reset exception must always be traced: 0 Reset exception is traced only if the instruction or exception immediately before the reset exception is traced. 1 Reset exception is always traced regardless of the value of ViewInst.
[9]	SSSTATUS	Indicates the current status of the start/stop logic: 0 Start/stop logic is in the stopped state. 1 Start/stop logic is in the started state.
[8]	-	Reserved, RES0.

Table 13-16 TRCVICTLR bit assignments (continued)

Bits	Name	Function
[7]	TYPE	Selects the resource type for the viewinst event: 0 Single selected resource. 1 Boolean combined resource pair.
[6:4]	-	Reserved, RES0.
[3:0]	SEL	Selects the resource number to use for the viewinst event, based on the value of TYPE: When TYPE is 0, selects a single selected resource from 0-15 defined by bits[3:0]. When TYPE is 1, selects a Boolean combined resource pair from 0-7 defined by bits[2:0].

The TRCVICTLR can be accessed through the internal memory-mapped interface and the external debug interface, offset 0x080.

13.8.14 ViewInst Include-Exclude Control Register

The TRCVIIECTLR characteristics are:

Purpose Defines the address range comparators that control the ViewInst Include/Exclude control.

Usage constraints

- You must always program this register as part of trace unit initialization.
- Accepts writes only when the trace unit is disabled.

Configurations Available in all configurations.

Attributes See the register summary in [Table 13-3 on page 13-10](#).

[Figure 13-16](#) shows the TRCVIIECTLR bit assignments.

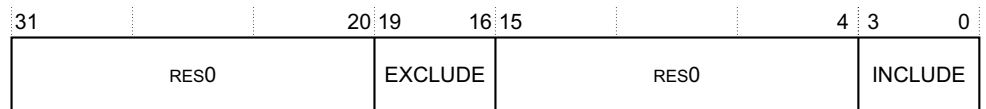
**Figure 13-16 TRCVIIECTLR bit assignments**

[Table 13-17](#) shows the TRCVIIECTLR bit assignments.

Table 13-17 TRCVIIECTLR bit assignments

Bits	Name	Function
[31:20]	-	Reserved, RES0.
[19:16]	EXCLUDE	Defines the address range comparators for ViewInst exclude control. One bit is provided for each implemented Address Range Comparator.
[15:4]	-	Reserved, RES0.
[3:0]	INCLUDE	Defines the address range comparators for ViewInst include control. Selecting no include comparators indicates that all instructions must be included. The exclude control indicates which ranges must be excluded. One bit is provided for each implemented Address Range Comparator.

The TRCVIIECTLR can be accessed through the internal memory-mapped interface and the external debug interface, offset 0x084.

13.8.15 ViewInst Start-Stop Control Register

The TRCVISSCTLR characteristics are:

Purpose	Defines the single address comparators that control the ViewInst Start/Stop logic.
Usage constraints	<ul style="list-style-type: none"> You must always program this register as part of trace unit initialization. Accepts writes only when the trace unit is disabled.
Configurations	Available in all configurations.
Attributes	See the register summary in Table 13-3 on page 13-10 .

[Figure 13-17](#) shows the TRCVISSCTLR bit assignments.

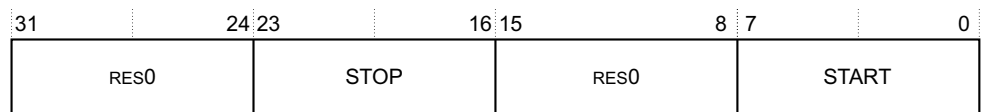

Figure 13-17 TRCVISSCTLR bit assignments

[Table 13-18](#) shows the TRCVISSCTLR bit assignments.

Table 13-18 TRCVISSCTLR bit assignments

Bits	Name	Function
[31:24]	-	Reserved, RES0.
[23:16]	STOP	Defines the single address comparators to stop trace with the ViewInst Start/Stop control. One bit is provided for each implemented single address comparator.
[15:8]	-	Reserved, RES0.
[7:0]	START	Defines the single address comparators to start trace with the ViewInst Start/Stop control. One bit is provided for each implemented single address comparator.

The TRCVISSCTLR can be accessed through the internal memory-mapped interface and the external debug interface, offset 0x088.

13.8.16 Sequencer State Transition Control Registers 0-2

The TRCSEQEVRn characteristics are:

Purpose	Defines the sequencer transitions that progress to the next state or backwards to the previous state. The ETM trace unit implements a sequencer state machine with up to four states.
Usage constraints	<ul style="list-style-type: none"> Accepts writes only when the trace unit is disabled. Returns stable data only when TRCSTATR.PMSTABLE==1. Software must use this register to set the initial state of the sequencer before the sequencer is used.
Configurations	Available in all configurations.

Attributes See the register summary in [Table 13-3 on page 13-10](#).

[Figure 13-18](#) shows the TRCSEQEVRn bit assignments.

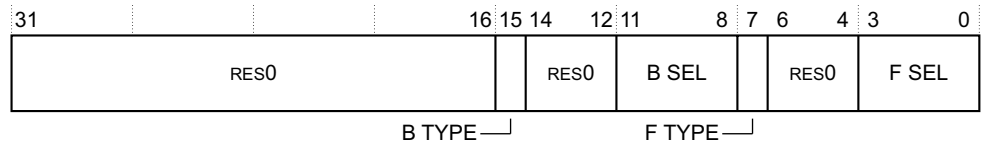

Figure 13-18 TRCSEQEVRn bit assignments

[Table 13-19](#) shows the TRCSEQEVRn bit assignments.

Table 13-19 TRCSEQEVRn bit assignments

Bits	Name	Function
[31:16]	-	Reserved, RES0.
[15]	B TYPE	Selects the resource type to move backwards to this state from the next state: 0 Single selected resource. 1 Boolean combined resource pair.
[14:12]	-	Reserved, RES0
[11:8]	B SEL	Selects the resource number, based on the value of B TYPE: When B TYPE is 0, selects a single selected resource from 0-15 defined by bits[3:0]. When B TYPE is 1, selects a Boolean combined resource pair from 0-7 defined by bits[2:0].
[7]	F TYPE	Selects the resource type to move forwards from this state to the next state: 0 Single selected resource. 1 Boolean combined resource pair.
[6:4]	-	Reserved, RES0.
[3:0]	F SEL	Selects the resource number, based on the value of F TYPE: When F TYPE is 0, selects a single selected resource from 0-15 defined by bits[3:0]. When F TYPE is 1, selects a Boolean combined resource pair from 0-7 defined by bits[2:0].

The TRCSEQEVRn registers can be accessed through the internal memory-mapped interface and the external debug interface, offsets:

TRCSEQEVR0 0x100.

TRCSEQEVR1 0x104.

TRCSEQEVR2 0x108.

13.8.17 Sequencer Reset Control Register

The TRCSEQRSTEVr characteristics are:

Purpose Resets the sequencer to state 0.

Usage constraints

- Accepts writes only when the trace unit is disabled.
- If the sequencer is used, you must program all sequencer state transitions with a valid event.

Configurations Available in all configurations.

Attributes See the register summary in [Table 13-3 on page 13-10](#).

Figure 13-19 shows the TRCSEQRSTEVR bit assignments.

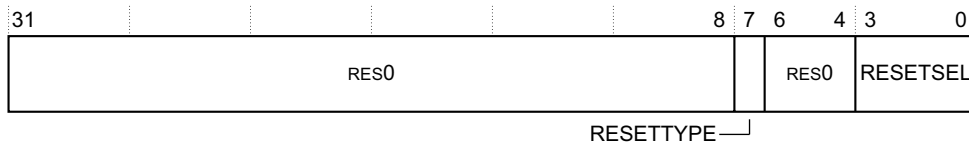

Figure 13-19 TRCSEQRSTEVR bit assignments

Table 13-20 shows the TRCSEQRSTEVR bit assignments.

Table 13-20 TRCSEQRSTEVR bit assignments

Bits	Name	Function
[31:8]	-	Reserved, RES0.
[7]	RESETTYPE	Selects the resource type to move back to state 0: 0 Single selected resource. 1 Boolean combined resource pair.
[6:4]	-	Reserved, RES0.
[3:0]	RESETSEL	Selects the resource number, based on the value of RESETTYPE: When RESETTYPE is 0, selects a single selected resource from 0-15 defined by bits[3:0]. When RESETTYPE is 1, selects a Boolean combined resource pair from 0-7 defined by bits[2:0].

The TRCSEQRSTEVR can be accessed through the internal memory-mapped interface and the external debug interface, offset 0x118.

13.8.18 Sequencer State Register

The TRCSEQSTR characteristics are:

- Purpose** Holds the value of the current state of the sequencer.
- Usage constraints**
 - Accepts writes only when the trace unit is disabled.
 - Returns stable data only when TRCSTATR.PMSTABLE==1.
 - Software must use this register to set the initial state of the sequencer before the sequencer is used.
- Configurations** Available in all configurations.
- Attributes** See the register summary in Table 13-3 on page 13-10.

Figure 13-20 shows the TRCSEQSTR bit assignments.

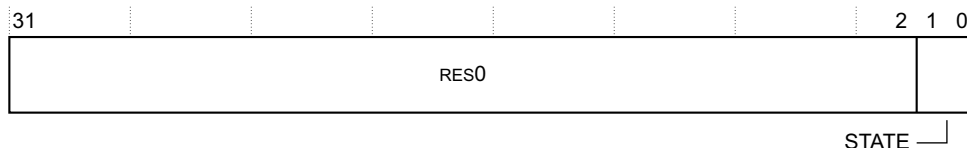

Figure 13-20 TRCSEQSTR bit assignments

Table 13-21 shows the TRCSEQSTR bit assignments.

Table 13-21 TRCSEQSTR bit assignments

Bits	Name	Function
[31:2]	-	Reserved, RES0.
[1:0]	STATE	Current sequencer state: b00 State 0. b01 State 1. b10 State 2. b11 State 3.

The TRCSEQSTR can be accessed through the internal memory-mapped interface and the external debug interface, offset 0x11c.

13.8.19 External Input Select Register

The TRCEXTINSELR characteristics are:

Purpose Controls the selectors that choose an external input as a resource in the ETM trace unit. You can use the Resource Selectors to access these external input resources.

Usage constraints Accepts writes only when the trace unit is disabled.

Configurations Available in all configurations.

Attributes See the register summary in Table 13-3 on page 13-10.

Figure 13-21 shows the TRCEXTINSELR bit assignments.

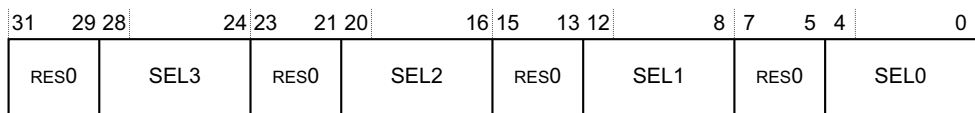

Figure 13-21 TRCEXTINSELR bit assignments

Table 13-22 shows the TRCEXTINSELR bit assignments.

Table 13-22 TRCEXTINSELR bit assignments

Bits	Name	Function
[31:29]	-	Reserved, RES0.
[28:24]	SEL3	Selects an event from the external input bus for External Input Resource 3.
[23:21]	-	Reserved, RES0.
[20:16]	SEL2	Selects an event from the external input bus for External Input Resource 2.
[15:13]	-	Reserved, RES0.
[12:8]	SEL1	Selects an event from the external input bus for External Input Resource 1.
[7:5]	-	Reserved, RES0.
[4:0]	SEL0	Selects an event from the external input bus for External Input Resource 0.

Table 13-24 shows the TRCCNTCTLR0 bit assignments.

Table 13-24 TRCCNTCTLR0 bit assignments

Bits	Name	Function
[31:17]	-	Reserved, RES0.
[16]	RLDSELF	Defines whether the counter reloads when it reaches zero: 0 The counter does not reload when it reaches zero. The counter only reloads based on RLDTYPE and RLDSEL. 1 The counter reloads when it reaches zero and the resource selected by CNTTYPE and CNTSEL is also active. The counter also reloads based on RLDTYPE and RLDSEL.
[15]	RLDTYPE	Selects the resource type for the reload: 0 Single selected resource. 1 Boolean combined resource pair.
[14:12]	-	Reserved, RES0.
[11:8]	RLDSEL	Selects the resource number, based on the value of RLDTYPE: When RLDTYPE is 0, selects a single selected resource from 0-15 defined by bits[3:0]. When RLDTYPE is 1, selects a Boolean combined resource pair from 0-7 defined by bits[2:0].
[7]	CNTTYPE	Selects the resource type for the counter: 0 Single selected resource. 1 Boolean combined resource pair.
[6:4]	-	Reserved, RES0.
[3:0]	CNTSEL	Selects the resource number, based on the value of CNTTYPE: When CNTTYPE is 0, selects a single selected resource from 0-15 defined by bits[3:0]. When CNTTYPE is 1, selects a Boolean combined resource pair from 0-7 defined by bits[2:0].

The TRCCNTCTLR0 can be accessed through the internal memory-mapped interface and the external debug interface, offset 0x150.

13.8.22 Counter Control Register 1

The TRCCNTCTLR1 characteristics are:

- Purpose** Controls the counter.
- Usage constraints** Accepts writes only when the trace unit is disabled.
- Configurations** Available in all configurations.
- Attributes** See the register summary in [Table 13-3 on page 13-10](#).

Figure 13-24 shows the TRCCNTCTLR1 bit assignments.

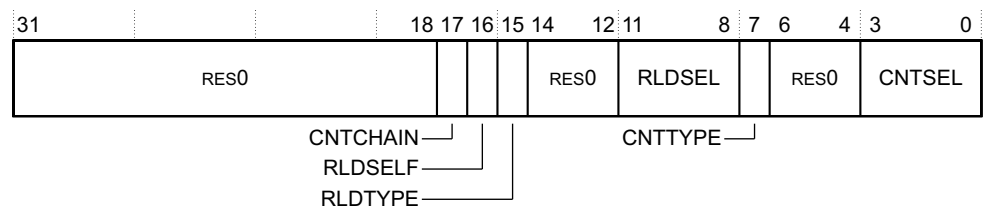

Figure 13-24 TRCCNTCTLR1 bit assignments

Table 13-25 shows the TRCCNTCTLR1 bit assignments.

Table 13-25 TRCCNTCTLR1 bit assignments

Bits	Name	Function
[31:18]	-	Reserved, RES0.
[17]	CNTCHAIN	Defines whether the counter decrements when the counter reloads. This enables two counters to be used in combination to provide a larger counter: 0 The counter operates independently from the counter. The counter only decrements based on CNTTYPE and CNTSEL. 1 The counter decrements when the counter reloads. The counter also decrements when the resource selected by CNTTYPE and CNTSEL is active.
[16]	RLDSELF	Defines whether the counter reloads when it reaches zero: 0 The counter does not reload when it reaches zero. The counter only reloads based on RLDTYPE and RLDSEL. 1 The counter reloads when it is zero and the resource selected by CNTTYPE and CNTSEL is also active. The counter also reloads based on RLDTYPE and RLDSEL.
[15]	RLDTYPE	Selects the resource type for the reload: 0 Single selected resource. 1 Boolean combined resource pair.
[14:12]	-	Reserved, RES0.
[11:8]	RLDSEL	Selects the resource number, based on the value of RLDTYPE: When RLDTYPE is 0, selects a single selected resource from 0-15 defined by bits[3:0]. When RLDTYPE is 1, selects a Boolean combined resource pair from 0-7 defined by bits[2:0].
[7]	CNTTYPE	Selects the resource type for the counter: 0 Single selected resource. 1 Boolean combined resource pair.
[6:4]	-	Reserved, RES0.
[3:0]	CNTSEL	Selects the resource number, based on the value of CNTTYPE: When CNTTYPE is 0, selects a single selected resource from 0-15 defined by bits[3:0]. When CNTTYPE is 1, selects a Boolean combined resource pair from 0-7 defined by bits[2:0].

The TRCCNTCTLR1 can be accessed through the internal memory-mapped interface and the external debug interface, offset 0x154.

13.8.23 Counter Value Registers 0-1

The TRCCNTVRn characteristics are:

Purpose	Contains the current counter value.
Usage constraints	<ul style="list-style-type: none"> • Can be written only when the ETM trace unit is disabled. • The count value is stable only when TRCSTATR.PMSTABLE==1. • If software uses counter <n>, then it must write to this register to set the initial counter value.
Configurations	Available in all configurations.
Attributes	See the register summary in Table 13-3 on page 13-10 .

Figure 13-25 shows the TRCCNTVRn bit assignments.

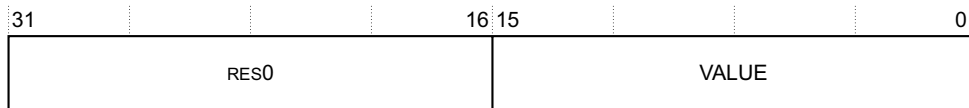

Figure 13-25 TRCCNTVRn bit assignments

Table 13-26 shows the TRCCNTVRn bit assignments.

Table 13-26 TRCCNTVRn bit assignments

Bits	Value	Function
[31:16]	-	Reserved, RES0.
[15:0]	VALUE	Contains the current counter value.

The TRCCNTVRn registers can be accessed through the internal memory-mapped interface and the external debug interface, offsets:

TRCCNTVR0 0x160.

TRCCNTVR1 0x164.

13.8.24 ID Register 8

The TRCIDR8 characteristics are:

Purpose Returns the maximum speculation depth of the instruction trace stream.

Usage constraints There are no usage constraints.

Configurations Available in all configurations.

Attributes See the register summary in Table 13-3 on page 13-10.

Figure 13-26 shows the TRCIDR8 bit assignments.



Figure 13-26 TRCIDR8 bit assignments

Table 13-27 shows the TRCIDR8 bit assignments.

Table 13-27 TRCIDR8 bit assignments

Bits	Name	Function
[31:0]	MAXSPEC	The maximum number of P0 elements in the trace stream that can be speculative at any time. 0 Maximum speculation depth of the instruction trace stream.

The TRCIDR8 can be accessed through the internal memory-mapped interface and the external debug interface, offset 0x180.

13.8.25 ID Register 9

The TRCIDR9 characteristics are:

- Purpose** Returns the number of P0 right-hand keys that the trace unit can use.
- Usage constraints** There are no usage constraints.
- Configurations** Available in all configurations.
- Attributes** See the register summary in [Table 13-3 on page 13-10](#).

[Figure 13-27](#) shows the TRCIDR9 bit assignments.

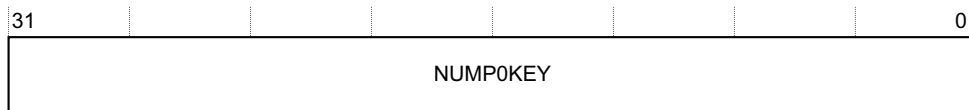

Figure 13-27 TRCIDR9 bit assignments

[Table 13-28](#) shows the TRCIDR9 bit assignments.

Table 13-28 TRCIDR9 bit assignments

Bits	Name	Function
[31:0]	NUMP0KEY	The number of P0 right-hand keys that the trace unit can use. 0 Number of P0 right-hand keys.

The TRCIDR9 can be accessed through the internal memory-mapped interface and the external debug interface, offset 0x184.

13.8.26 ID Register 10

The TRCIDR10 characteristics are:

- Purpose** Returns the number of P1 right-hand keys that the trace unit can use.
- Usage constraints** There are no usage constraints.
- Configurations** Available in all configurations.
- Attributes** See the register summary in [Table 13-3 on page 13-10](#).

[Figure 13-28](#) shows the TRCIDR10 bit assignments.

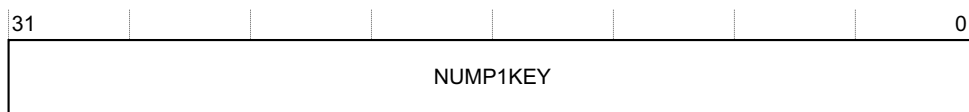

Figure 13-28 TRCIDR10 bit assignments

Table 13-29 shows the TRCIDR10 bit assignments.

Table 13-29 TRCIDR10 bit assignments

Bits	Name	Function
[31:0]	NUMP1KEY	The number of P1 right-hand keys that the trace unit can use. 0 Number of P1 right-hand keys.

The TRCIDR10 can be accessed through the internal memory-mapped interface and the external debug interface, offset 0x188.

13.8.27 ID Register 11

The TRCIDR11 characteristics are:

Purpose	Returns the number of special P1 right-hand keys that the trace unit can use.
Usage constraints	There are no usage constraints.
Configurations	Available in all configurations.
Attributes	See the register summary in Table 13-3 on page 13-10 .

Figure 13-29 shows the TRCIDR11 bit assignments.

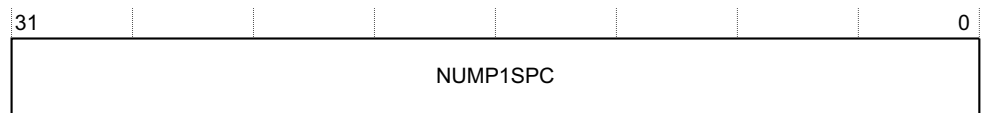

Figure 13-29 TRCIDR11 bit assignments

Table 13-30 shows the TRCIDR11 bit assignments.

Table 13-30 TRCIDR11 bit assignments

Bits	Name	Function
[31:0]	NUMP1SPC	The number of special P1 right-hand keys that the trace unit can use. 0 Number of special P1 right-hand keys.

The TRCIDR11 can be accessed through the internal memory-mapped interface and the external debug interface, offset 0x18C.

13.8.28 ID Register 12

The TRCIDR12 characteristics are:

Purpose	Returns the number of conditional instruction right-hand keys that the trace unit can use.
Usage constraints	There are no usage constraints.
Configurations	Available in all configurations.
Attributes	See the register summary in Table 13-3 on page 13-10 .

Figure 13-30 on page 13-37 shows the TRCIDR12 bit assignments.

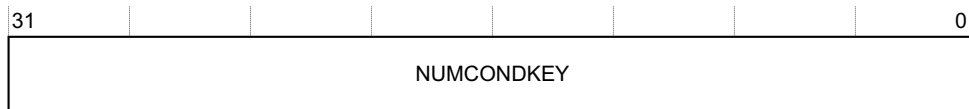

Figure 13-30 TRCIDR12 bit assignments

Table 13-31 shows the TRCIDR12 bit assignments.

Table 13-31 TRCID12 bit assignments

Bits	Name	Function
[31:0]	NUMCONDKEY	The number of conditional instruction right-hand keys that the trace unit can use, including normal and special keys. 0 Number of conditional instruction right-hand keys.

The TRCIDR12 can be accessed through the internal memory-mapped interface and the external debug interface, offset 0x190.

13.8.29 ID Register 13

The TRCIDR13 characteristics are:

- Purpose** Returns the number of special conditional instruction right-hand keys that the trace unit can use.
- Usage constraints** There are no usage constraints.
- Configurations** Available in all configurations.
- Attributes** See the register summary in [Table 13-3 on page 13-10](#).

Figure 13-31 shows the TRCIDR13 bit assignments.

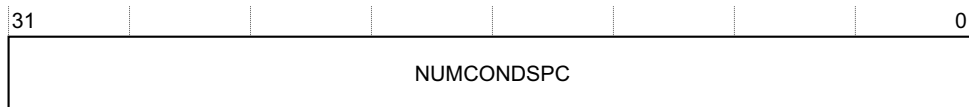

Figure 13-31 TRCIDR13 bit assignments

Table 13-32 shows the TRCIDR13 bit assignments.

Table 13-32 TRCID13 bit assignments

Bits	Name	Function
[31:0]	NUMCONDSPC	The number of special conditional instruction right-hand keys that the trace unit can use, including normal and special keys. 0 Number of special conditional instruction right-hand keys.

The TRCIDR13 can be accessed through the internal memory-mapped interface and the external debug interface, offset 0x194.

13.8.30 Implementation Specific Register 0

The TRCIMSPEC0 characteristics are:

- Purpose** Shows the presence of any implementation specific features, and enables any features that are provided.
- Usage constraints** There are no usage constraints.
- Configurations** Available in all configurations.
- Attributes** See the register summary in [Table 13-3 on page 13-10](#).

[Figure 13-32](#) shows the TRCIMSPEC0 bit assignments.

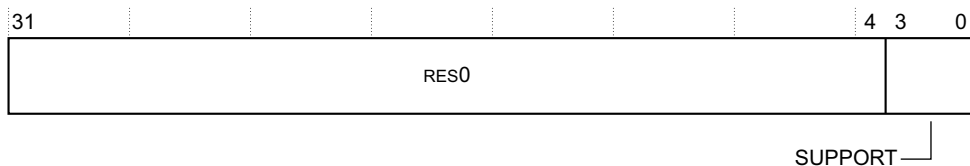

Figure 13-32 TRCIMSPEC0 bit assignments

[Table 13-33](#) shows the TRCIMSPEC0 bit assignments.

Table 13-33 TRCIMSPEC0 bit assignments

Bits	Name	Function
[31:4]	-	Reserved, RES0.
[3:0]	SUPPORT	0 No implementation specific extensions are supported.

The TRCIMSPEC0 can be accessed through the internal memory-mapped interface and the external debug interface, offset 0x1C0.

13.8.31 ID Register 0

The TRCIDR0 characteristics are:

- Purpose** Returns the tracing capabilities of the ETM trace unit.
- Usage constraints** There are no usage constraints.
- Configurations** Available in all configurations.
- Attributes** See the register summary in [Table 13-3 on page 13-10](#).

[Figure 13-33 on page 13-39](#) shows the TRCIDR0 bit assignments.

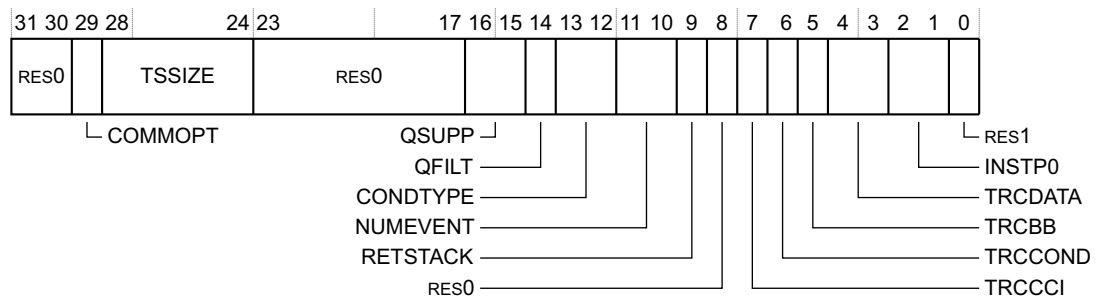

Figure 13-33 TRCIDR0 bit assignments

Table 13-34 shows the TRCIDR0 bit assignments.

Table 13-34 TRCIDR0 bit assignments

Bits	Name	Function
[31:30]	-	Reserved, RES0.
[29]	COMMOPT	Indicates the meaning of the commit field in some packets: 1 Commit mode 1.
[28:24]	TSSIZE	Global timestamp size field: 0b01000 Implementation supports a maximum global timestamp of 64 bits.
[23:17]	-	Reserved, RES0.
[16:15]	QSUPP	Indicates Q element support: b00 Q elements not supported.
[14]	QFILT	Indicates Q element filtering support: b0 Q element filtering not supported.
[13:12]	CONDTYPE	Indicates how conditional results are traced: b00 Conditional trace not supported.
[11:10]	NUMEVENT	Number of events supported in the trace, minus 1: b11 Four events supported.
[9]	RETSTACK	Return stack support: 1 Return stack implemented.
[8]	-	Reserved, RES0.
[7]	TRCCCI	Support for cycle counting in the instruction trace: 1 Cycle counting in the instruction trace is implemented.
[6]	TRCCOND	Support for conditional instruction tracing: 0 Conditional instruction tracing is not supported.
[5]	TRCB B	Support for branch broadcast tracing: 1 Branch broadcast tracing is implemented.
[4:3]	TRC DATA	Conditional tracing field: 0b00 Tracing of data addresses and data values is not implemented.
[2:1]	INSTP0	P0 tracing support field: 0b00 Tracing of load and store instructions as P0 elements is not supported.
[0]	-	Reserved, RES1.

The TRCIDR0 can be accessed through the internal memory-mapped interface and the external debug interface, offset 0x1E0.

13.8.32 ID Register 1

The TRCIDR1 characteristics are:

Purpose	Returns the base architecture of the trace unit.
Usage constraints	There are no usage constraints.
Configurations	Available in all configurations.
Attributes	See the register summary in Table 13-3 on page 13-10 .

[Figure 13-34](#) shows the TRCIDR1 bit assignments.

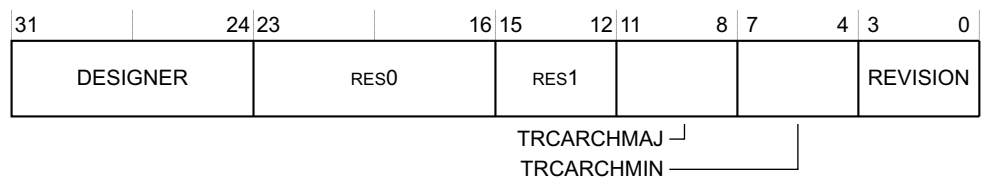

Figure 13-34 TRCIDR1 bit assignments

[Table 13-35](#) shows the TRCIDR1 bit assignments.

Table 13-35 TRCIDR1 bit assignments

Bits	Name	Function
[31:24]	DESIGNER	Indicates which company designed the trace unit: 0x41 ARM.
[23:16]	-	Reserved, RES0.
[15:12]	-	Reserved, RES1.
[11:8]	TRCARCHMAJ	Major trace unit architecture version number: 0b0100 ETMv4.
[7:4]	TRCARCHMIN	Minor trace unit architecture version number: 0b0000 Minor revision 0.
[3:0]	REVISION	Implementation revision number: 0b0010 r0p2.

The TRCIDR1 can be accessed through the internal memory-mapped interface and the external debug interface, offset 0x1E4.

13.8.33 ID Register 2

The TRCIDR2 characteristics are:

Purpose	Returns the maximum size of the following parameters in the trace unit: <ul style="list-style-type: none"> • Cycle counter. • Data value. • Data address. • VMID.
----------------	---

- Context ID.
- Instruction address.

Usage constraints There are no usage constraints.

Configurations Available in all configurations.

Attributes See the register summary in [Table 13-3 on page 13-10](#).

[Figure 13-35](#) shows the TRCIDR2 bit assignments.

31	29	28	25	24	20	19	15	14	10	9	5	4	0
RES0			CCSIZE		DVSIZE		DASIZE		VMIDSIZE		CIDSIZE		IASIZE

Figure 13-35 TRCIDR2 bit assignments

[Table 13-36](#) shows the TRCIDR2 bit assignments.

Table 13-36 TRCIDR2 bit assignments

Bits	Name	Function
[31:29]	-	Reserved, RES0.
[28:25]	CCSIZE	Size of the cycle counter in bits minus 12: 0x0 The cycle counter is 12 bits in length.
[24:20]	DVSIZE	Data value size in bytes: 0x0 Data value tracing is not implemented.
[19:15]	DASIZE	Data address size in bytes: 0x0 Data address tracing is not implemented.
[14:10]	VMIDSIZE	Virtual Machine ID size: 0x1 Virtual Machine ID is 8 bits.
[9:5]	CIDSIZE	Context ID size in bytes: 0x4 Maximum of 32-bit Context ID size.
[4:0]	IASIZE	Instruction address size in bytes: 0x8 Maximum of 64-bit address size.

The TRCIDR2 can be accessed through the internal memory-mapped interface and the external debug interface, offset 0x1E8.

13.8.34 ID Register 3

The TRCIDR3 characteristics are:

Purpose

Indicates:

- Whether TRCVICTLR is supported.
- The number of cores available for tracing.
- If an exception level supports instruction tracing.
- The minimum threshold value for instruction trace cycle counting.
- Whether the synchronization period is fixed.

- Whether TRCSTALLCTLR is supported and if so whether it supports trace overflow prevention and supports stall control of the processor.

Usage constraints There are no usage constraints.

Configurations Available in all configurations.

Attributes See the register summary in [Table 13-3 on page 13-10](#).

Figure 13-36 shows the TRCIDR3 bit assignments.

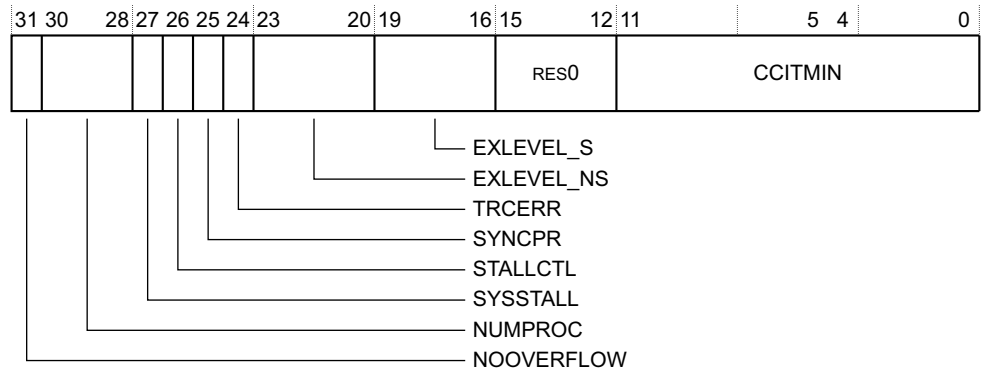

Figure 13-36 TRCIDR3 bit assignments

Table 13-37 shows the TRCIDR3 bit assignments.

Table 13-37 TRCIDR3 bit assignments

Bits	Name	Function
[31]	NOOVERFLOW	Indicates whether TRCSTALLCTLR.NOOVERFLOW is implemented: 0 TRCSTALLCTLR.NOOVERFLOW is not implemented.
[30:28]	NUMPROC	Indicates the number of cores available for tracing: 0b000 The trace unit can trace one processor, ETM trace unit sharing not supported.
[27]	SYSSTALL	Indicates whether stall control is implemented: 1 The system supports processor stall control.
[26]	STALLCTL	Indicates whether TRCSTALLCTLR is implemented: 1 TRCSTALLCTLR is implemented. This field is used in conjunction with SYSSTALL.
[25]	SYNCPR	Indicates whether there is a fixed synchronization period: 0 TRCSYNCPR is read-write so software can change the synchronization period.
[24]	TRCERR	Indicates whether TRCVICTLR.TRCERR is implemented: 1 TRCVICTLR.TRCERR is implemented.
[23:20]	EXLEVEL_NS	Each bit controls whether instruction tracing in Non-secure state is implemented for the corresponding exception level: 0b0111 Instruction tracing is implemented for Non-secure EL0, EL1 and EL2 exception levels.

Table 13-37 TRCIDR3 bit assignments (continued)

Bits	Name	Function
[19:16]	EXLEVEL_S	Each bit controls whether instruction tracing in Secure state is implemented for the corresponding exception level: 0b1011 Instruction tracing is implemented for Secure EL0, EL1 and EL3 exception levels.
[15:12]	-	Reserved, RES0.
[11:0]	CCITMIN	The minimum value that can be programmed in TRCCCCTLR.THRESHOLD: 0x004 Instruction trace cycle counting minimum threshold is 4.

The TRCIDR3 can be accessed through the internal memory-mapped interface and the external debug interface, offset 0x1EC.

13.8.35 ID Register 4

The TRCIDR4 characteristics are:

- Purpose** Indicates the resources available in the ETM trace unit.
- Usage constraints** There are no usage constraints.
- Configurations** Available in all configurations.
- Attributes** See the register summary in [Table 13-3 on page 13-10](#).

[Figure 13-37](#) shows the TRCIDR4 bit assignments.

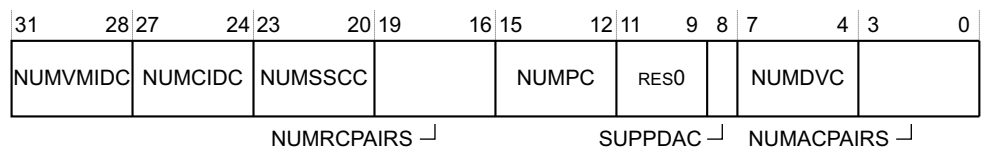

Figure 13-37 TRCIDR4 bit assignments

[Table 13-38](#) shows the TRCIDR4 bit assignments.

Table 13-38 TRCIDR4 bit assignments

Bits	Name	Function
[31:28]	NUMVMIDC	Indicates the number of VMID comparators available for tracing: 0x1 One VMID comparator is available.
[27:24]	NUMCIDC	Indicates the number of CID comparators available for tracing: 0x1 One Context ID comparator is available.
[23:20]	NUMSSCC	Indicates the number of single-shot comparator controls available for tracing: 0x1 One single-shot comparator control is available.
[19:16]	NUMRPAIR	Indicates the number of resource selection pairs available for tracing: 0x7 Eight resource selection pairs are available.
[15:12]	NUMPC	Indicates the number of processor comparator inputs available for tracing: 0x0 Processor comparator inputs are not implemented.
[11:9]	-	Reserved, RES0.

Table 13-38 TRCIDR4 bit assignments (continued)

Bits	Name	Function
[8]	SUPPDAC	Indicates whether the implementation supports data address comparisons: This value is: 0 Data address comparisons are not implemented.
[7:4]	NUMDVC	Indicates the number of data value comparators available for tracing: 0x0 Data value comparators not implemented.
[3:0]	NUMACPPAIRS	Indicates the number of address comparator pairs available for tracing: 0x4 Four address comparator pairs are implemented.

The TRCIDR4 can be accessed through the internal memory-mapped interface and the external debug interface, offset 0x1F0.

13.8.36 ID Register 5

The TRCIDR5 characteristics are:

- Purpose** Returns how many resources the trace unit supports.
- Usage constraints** There are no usage constraints.
- Configurations** Available in all configurations.
- Attributes** See the register summary in [Table 13-3 on page 13-10](#).

[Figure 13-38](#) shows the TRCIDR5 bit assignments.

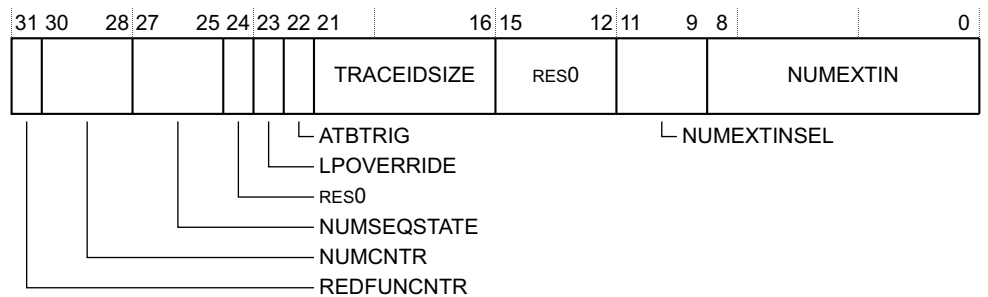

Figure 13-38 TRCIDR5 bit assignments

[Table 13-39](#) shows the TRCIDR5 bit assignments.

Table 13-39 TRCIDR5 bit assignments

Bits	Name	Function
[31]	REDFUNCNTR	Reduced Function Counter implemented: 0 Reduced Function Counter not implemented.
[30:28]	NUMCCNTR	Number of counters implemented: b010 Two counters implemented.
[27:25]	NUMSEQSTATE	Number of sequencer states implemented: b100 Four sequencer states implemented.
[24]	-	Reserved, RES0.

Table 13-39 TRCIDR5 bit assignments (continued)

Bits	Name	Function
[23]	LPOVERRIDE	Low power state override support: 1 Low power state override support implemented.
[22]	ATBTRIG	ATB trigger support: 1 ATB trigger support implemented.
[21:16]	TRACEIDSIZE	Number of bits of trace ID: 0x07 Seven-bit trace ID implemented.
[15:12]	-	Reserved, RES0.
[11:9]	NUMEXTINSEL	Number of external input selectors implemented: b100 Four external input selectors implemented.
[8:0]	NUMEXTIN	Number of external inputs implemented: 0x1E 30 external inputs implemented.

The TRCIDR5 can be accessed through the internal memory-mapped interface and the external debug interface, offset 0x1F4.

13.8.37 Resource Selection Control Registers 2-16

The TRCRSCTLRn characteristics are:

- Purpose** Controls the trace resources.
There are eight resource pairs, the first pair is predefined as {0,1,pair=0} and having reserved select registers. This leaves seven pairs to be implemented as programmable selectors.
- Usage constraints** Accepts writes only when the trace unit is disabled.
- Configurations** Available in all configurations.
- Attributes** See the register summary in [Table 13-3 on page 13-10](#).

[Figure 13-39](#) shows the TRCRSCTLRn bit assignments.

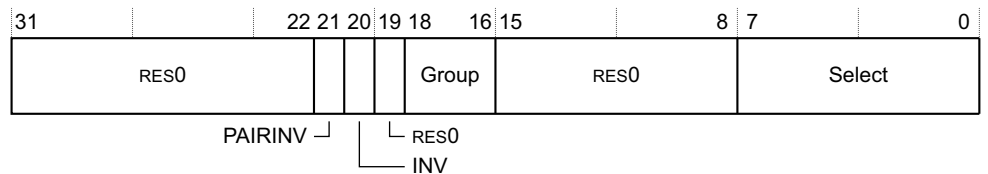

Figure 13-39 TRCRSCTLRn bit assignments

Table 13-40 shows the TRCRSCTLRn bit assignments.

Table 13-40 TRCSCTLRn bit assignments

Bits	Name	Function
[31:22]	-	Reserved, RES0.
[21]	PAIRINV	Inverts the result of a combined pair of resources. This bit is implemented only on the lower register for a pair of resource selectors.
[20]	INV	Inverts the selected resources: 0 Resource is not inverted. 1 Resource is inverted.
[19]	-	Reserved, RES0.
[18:16]	GROUP	Selects a group of resources. See the <i>ARM® ETM™ Architecture Specification, ETMv4</i> for more information.
[15:8]	-	Reserved, RES0.
[7:0]	SELECT	Selects one or more resources from the required group. One bit is provided for each resource from the group.

The TRCRSCTLRn can be accessed through the internal memory-mapped interface and the external debug interface, offset 0x208-023C.

13.8.38 Single-Shot Comparator Control Register 0

The TRCSSCCR0 characteristics are:

- Purpose** Controls the single-shot comparator.
- Usage constraints** Accepts writes only when the trace unit is disabled.
- Configurations** Available in all configurations.
- Attributes** See the register summary in [Table 13-3 on page 13-10](#).

Figure 13-40 shows the TRCSSCCR0 bit assignments.

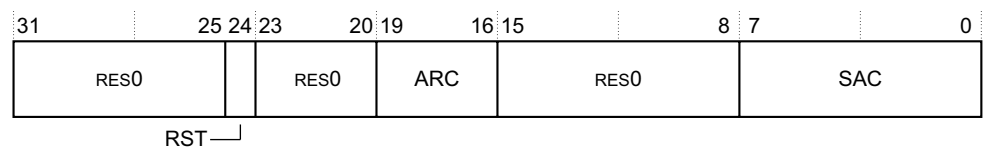

Figure 13-40 TRCSSCCR0 bit assignments

Table 13-41 shows the TRCSSCCR0 bit assignments.

Table 13-41 TRCSSCCR0 bit assignments

Bits	Name	Function
[31:25]	-	Reserved, RES0.
[24]	RST	Enables the single-shot comparator resource to be reset when it occurs, to enable another comparator match to be detected: 1 Reset enabled. Multiple matches can occur.
[23:20]	-	Reserved, RES0.

Table 13-41 TRCSSCCR0 bit assignments (continued)

Bits	Name	Function
[19:16]	ARC	Selects one or more address range comparators for single-shot control. One bit is provided for each implemented address range comparator.
[15:8]	-	Reserved, RES0.
[7:0]	SAC	Selects one or more single address comparators for single-shot control. One bit is provided for each implemented single address comparator.

The TRCSSCCR0 can be accessed through the internal memory-mapped interface and the external debug interface, offset 0x280.

13.8.39 Single-Shot Comparator Status Register 0

The TRCSSCSR0 characteristics are:

- Purpose** Indicates the status of the single-shot comparator:
 - TRCSSCSR0 is sensitive to instruction addresses.
- Usage constraints**
 - Accepts writes only when the trace unit is disabled.
 - The STATUS bit value is stable only when TRCSTATR.PMSTABLE==1.
- Configurations** Available in all configurations.
- Attributes** See the register summary in [Table 13-3 on page 13-10](#).

[Figure 13-41](#) shows the TRCSSCSR0 bit assignments.

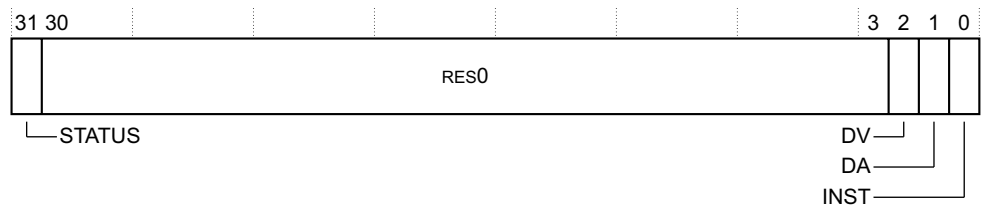

Figure 13-41 TRCSSCSR0 bit assignments

[Table 13-42](#) shows the TRCSSCSR0 bit assignments.

Table 13-42 TRCSSCSR0 bit assignments

Bits	Name	Function
[31]	STATUS	Single-shot status. This indicates whether any of the selected comparators have matched: 0 Match has not occurred. 1 Match has occurred at least once. When programming the ETM trace unit, if TRCSSCCRn.RST is b0, the STATUS bit must be explicitly written to 0 to enable this single-shot comparator control.
[30:3]	-	Reserved, RES0.

Table 13-42 TRCSSCSR0 bit assignments (continued)

Bits	Name	Function
[2]	DV	Data value comparator support: 0 Single-shot data value comparisons not supported.
[1]	DA	Data address comparator support: 0 Single-shot data address comparisons not supported.
[0]	INST	Instruction address comparator support: 1 Single-shot instruction address comparisons supported.

The TRCSSCSR0 can be accessed through the internal memory-mapped interface and the external debug interface, offset 0x2A0.

13.8.40 OS Lock Access Register

The TRCOSLAR characteristics are:

- Purpose** Sets and clears the OS Lock, to lock out external debugger accesses to the ETM trace unit registers.
- Usage constraints** There are no usage constraints.
- Configurations** Available in all configurations.
- Attributes** See the register summary in [Table 13-3 on page 13-10](#).

[Figure 13-42](#) shows the TRCOSLAR bit assignments.

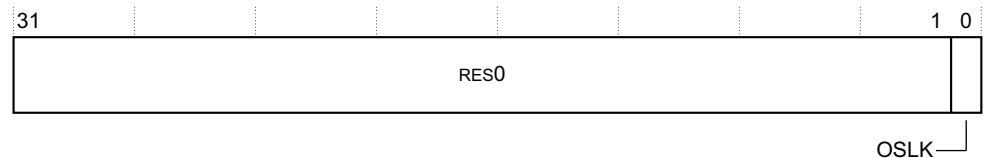

Figure 13-42 TRCOSLAR bit assignments

[Table 13-43](#) shows the TRCOSLAR bit assignments.

Table 13-43 TRCOSLAR bit assignments

Bits	Name	Function
[31:1]	-	TRCRSCTLRN
[0]	OSLK	OS Lock key value: 0 Unlock the OS Lock. 1 Lock the OS Lock.

The TRCOSLAR can be accessed through the internal memory-mapped interface and the external debug interface, offset 0x300.

13.8.41 OS Lock Status Register

The TRCOSLSR characteristics are:

- Purpose** Returns the status of the OS Lock.

Usage constraints There are no usage constraints.

Configurations Available in all configurations.

Attributes See the register summary in [Table 13-3 on page 13-10](#).

[Figure 13-43](#) shows the TRCOSLSR bit assignments.

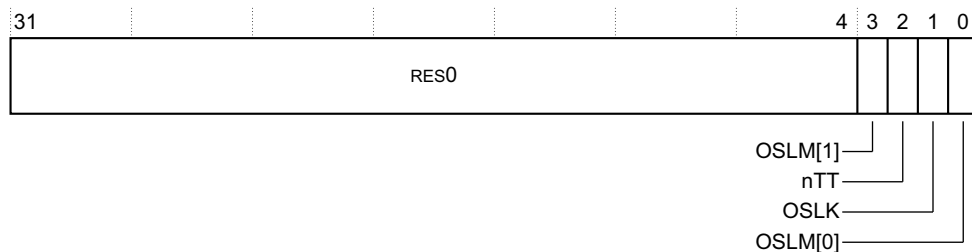

Figure 13-43 TRCOSLSR bit assignments

[Table 13-44](#) shows the TRCOSLSR bit assignments.

Table 13-44 TRCOSLSR bit assignments

Bits	Name	Function
[31:4]	-	TRCRSCTLRN
[3]	OSLM[1]	OS Lock model [1] bit. This bit is combined with OSLM[0] to form a two-bit field that indicates the OS Lock model is implemented. The value of this field is always 0b10, indicating that the OS Lock is implemented.
[2]	nTT	This bit is RAZ, that indicates that software must perform a 32-bit write to update the TRCOSLAR.
[1]	OSLK	OS Lock status bit: 0 OS Lock is unlocked. 1 OS Lock is locked.
[0]	OSLM[0]	OS Lock model [0] bit. This bit is combined with OSLM[1] to form a two-bit field that indicates the OS Lock model is implemented. The value of this field is always 0b10, indicating that the OS Lock is implemented.

The TRCOSLSR can be accessed through the internal memory-mapped interface and the external debug interface, offset 0x304.

13.8.42 Power Down Control Register

The TRCPDCR characteristics are:

Purpose Request to the system power controller to keep the ETM trace unit powered up.

Usage constraints There are no usage constraints.

Configurations Available in all configurations.

Attributes See the register summary in [Table 13-3 on page 13-10](#).

[Figure 13-44 on page 13-50](#) shows the TRCPDCR bit assignments.

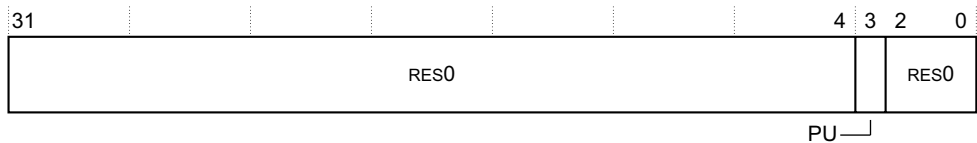

Figure 13-44 TRCPDCR bit assignments

Table 13-45 shows the TRCPDCR bit assignments.

Table 13-45 TRCPDCR bit assignments

Bits	Name	Function
[31:4]	-	Reserved, RES0.
[3]	PU	Powerup request, to request that power to the ETM trace unit and access to the trace registers is maintained: 0 Power not requested. 1 Power requested. This bit is reset to 0 on a trace unit reset.
[2:0]	-	Reserved, RES0.

The TRCPDCR can be accessed through the internal memory-mapped interface and the external debug interface, offset 0x310.

13.8.43 Power Down Status Register

The TRCPDSR characteristics are:

- Purpose** Indicates the power down status of the ETM trace unit.
- Usage constraints** There are no usage constraints.
- Configurations** Available in all configurations.
- Attributes** See the register summary in Table 13-3 on page 13-10.

Figure 13-45 shows the TRCPDSR bit assignments.

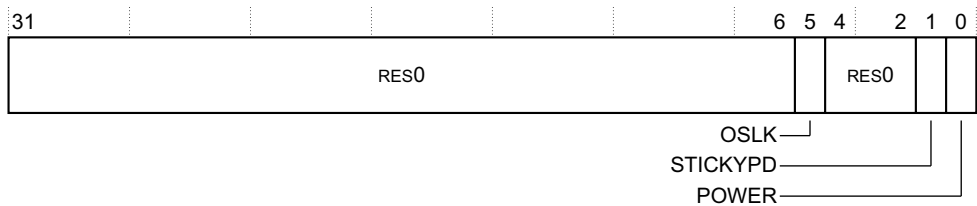

Figure 13-45 TRCPDSR bit assignments

Table 13-46 shows the TRCPDSR bit assignments.

Table 13-46 TRCPDSR bit assignments

Bits	Name	Function
[31:6]	-	Reserved, RES0.
[5]	OSLK	OS lock status. 0 The OS Lock is unlocked. 1 The OS Lock is locked.
[4:2]	-	Reserved, RES0.
[1]	STICKYPD	Sticky power down state. 0 Trace register power has not been removed since the TRCPDSR was last read. 1 Trace register power has been removed since the TRCPDSR was last read. This bit is set to 1 when power to the ETM trace unit registers is removed, to indicate that programming state has been lost. It is cleared after a read of the TRCPDSR.
[0]	POWER	Indicates the ETM trace unit is powered: 0 ETM trace unit is not powered. The trace registers are not accessible and they all return an error response. 1 ETM trace unit is powered. All registers are accessible. If a system implementation allows the ETM trace unit to be powered off independently of the debug power domain, the system must handle accesses to the ETM trace unit appropriately.

The TRCPDSR can be accessed through the internal memory-mapped interface and the external debug interface, offset 0x314.

13.8.44 Address Comparator Value Registers 0-7

The TRCACVRn characteristics are:

- Purpose** Indicates the address for the address comparators.
- Usage constraints** Accepts writes only when the trace unit is disabled.
- Configurations** Available in all configurations.
- Attributes** See the register summary in [Table 13-3 on page 13-10](#).

Figure 13-46 shows the TRCACVRn bit assignments.



Figure 13-46 TRCACVRn bit assignments

Table 13-47 shows the TRCACVRn bit assignments.

Table 13-47 TRCACVRn bit assignments

Bits	Name	Function
[63:0]	ADDRESS	The address value to compare against.

Table 13-48 shows the TRCACATR n bit assignments.

Table 13-48 TRCACATR n bit assignments

Bits	Name	Function
[63:16]	-	Reserved, RES0.
[15:12]	EXLEVEL_NS	<p>Each bit controls whether a comparison can occur in Non-secure state for the corresponding exception level. The possible values are:</p> <p>0 The trace unit can perform a comparison, in Non-secure state, for exception level n.</p> <p>1 The trace unit does not perform a comparison, in Non-secure state, for exception level n.</p> <p>———— Note —————</p> <p>The exception levels are:</p> <p>Bit[12] Exception level 0.</p> <p>Bit[13] Exception level 1.</p> <p>Bit[14] Exception level 2.</p> <p>Bit[15] Always RES0.</p>
[11:8]	EXLEVEL_S	<p>Each bit controls whether a comparison can occur in Secure state for the corresponding exception level. The possible values are:</p> <p>0 The trace unit can perform a comparison, in Secure state, for exception level n.</p> <p>1 The trace unit does not perform a comparison, in Secure state, for exception level n.</p> <p>———— Note —————</p> <p>The exception levels are:</p> <p>Bit[8] Exception level 0.</p> <p>Bit[9] Exception level 1.</p> <p>Bit[10] Always RES0.</p> <p>Bit[11] Exception level 3.</p>
[7:4]	-	Reserved, RES0.
[3:2]	Context type	<p>Controls whether the trace unit performs a Context ID comparison, a VMID comparison, or both comparisons:</p> <p>0b00 The trace unit does not perform a Context ID comparison.</p> <p>0b01 The trace unit performs a Context ID comparison using the Context ID comparator that the CONTEXT field specifies, and signals a match if both the Context ID comparator matches and the address comparator match.</p> <p>0b10 The trace unit performs a VMID comparison using the VMID comparator that the CONTEXT field specifies, and signals a match if both the VMID comparator and the address comparator match.</p> <p>0b11 The trace unit performs a Context ID comparison and a VMID comparison using the comparators that the CONTEXT field specifies, and signals a match if the Context ID comparator matches, the VMID comparator matches, and the address comparator matches.</p>
[1:0]	Type	<p>The type of comparison:</p> <p>b00 Instruction address, RES0.</p>

The TRCACATR n can be accessed through the internal memory-mapped interface and the external debug interface, offset 0x480-0x4B8.

13.8.46 Context ID Comparator Value Register 0

The TRCCIDCVR0 characteristics are:

- Purpose** Contains a Context ID value.
- Usage constraints** Accepts writes only when the trace unit is disabled.
- Configurations** Available in all configurations.
- Attributes** See the register summary in [Table 13-3 on page 13-10](#).

[Figure 13-48](#) shows the TRCCIDCVR0 bit assignments.

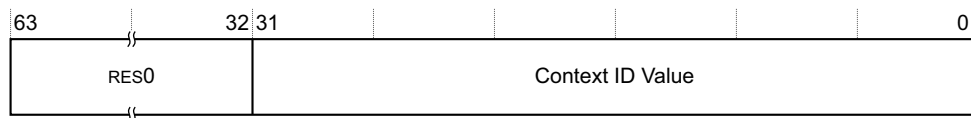

Figure 13-48 TRCCIDCVR0 bit assignments

[Table 13-49](#) shows the TRCCIDCVR0 bit assignments.

Table 13-49 TRCCIDCVR0 bit assignments

Bits	Name	Function
[63:32]	-	Reserved, RES0.
[31:0]	VALUE	The data value to compare against

The TRCCIDCVR0 can be accessed through the internal memory-mapped interface and the external debug interface, offset 0x600.

13.8.47 VMID Comparator Value Register 0

The TRCVMIDCVR0 characteristics are:

- Purpose** Contains a VMID value.
- Usage constraints** Accepts writes only when the trace unit is disabled.
- Configurations** Available in all configurations.
- Attributes** See the register summary in [Table 13-3 on page 13-10](#).

[Figure 13-49](#) shows the TRCVMIDCVR0 bit assignments.

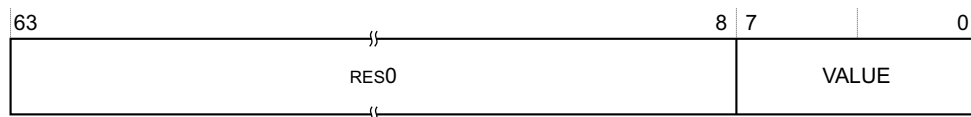

Figure 13-49 TRCVMIDCVR0 bit assignments

Table 13-50 shows the TRCVMICVVR0 bit assignments.

Table 13-50 TRCVMICVVR0 bit assignments

Bits	Name	Function
[63:8]	-	Reserved, RES0
[7:0]	VALUE	The VMID value

The TRCVMICVVR0 can be accessed through the internal memory-mapped interface and the external debug interface, offset 0x640.

13.8.48 Context ID Comparator Control Register 0

The TRCCIDCCTLR0 characteristics are:

- Purpose** Controls the mask value for the context ID comparators.
- Usage constraints**
- Accepts writes only when the trace unit is disabled.
 - If software uses the TRCCIDCVRn registers, where n=0 to 3, then it must program this register.
 - If software sets a mask bit to 1 then it must program the relevant byte in TRCCIDCVRn to 0x00.
- Configurations** Available in all configurations.
- Attributes** See the register summary in Table 13-3 on page 13-10.

Figure 13-50 shows the TRCCIDCCTLR0 bit assignments.

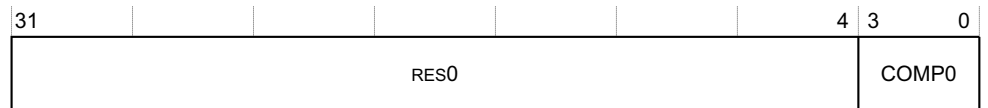

Figure 13-50 TRCCIDCCTLR0 bit assignments

Table 13-51 shows the TRCCIDCCTLR0 bit assignments.

Table 13-51 TRCCIDCCTLR0 bit assignments

Bits	Name	Function
[31:4]	-	Reserved, RES0.
[3:0]	COMP0	Controls the mask value that the trace unit applies to TRCCIDCVR0. Each bit in this field corresponds to a byte in TRCCIDCVR0. When a bit is: 0 The trace unit includes the relevant byte in TRCCIDCVR0 when it performs the Context ID comparison. 1 The trace unit ignores the relevant byte in TRCCIDCVR0 when it performs the Context ID comparison.

The TRCCIDCCTLR0 can be accessed through the internal memory-mapped interface and the external debug interface, offset 0x680.

13.8.49 Integration ATB Identification Register

The TRCITATBIDR characteristics are:

- Purpose** Sets the state of output pins shown in [Table 13-52](#).
- Usage constraints**
- Available when bit[0] of TRCITCTRL is set to 1.
 - The value of the register sets the signals on the output pins when the register is written.
- Configurations** Available in all configurations.
- Attributes** See the register summary in [Table 13-3 on page 13-10](#).

[Figure 13-51](#) shows the TRCITATBIDR bit assignments.

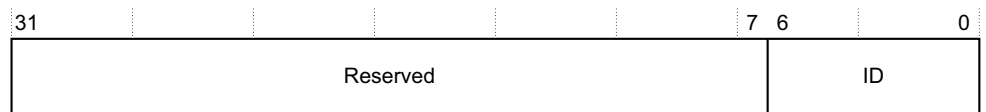

Figure 13-51 TRCITATBIDR bit assignments

[Table 13-52](#) shows the TRCITATBIDR bit assignments.

Table 13-52 TRCITATBIDR bit assignments

Bits	Name	Function
[31:7]	-	Reserved. Read undefined.
[6:0]	ID	Drives the ATIDMn[6:0] output pins ^a .

- a. When a bit is set to 0, the corresponding output pin is LOW. When a bit is set to 1, the corresponding output pin is HIGH. The TRCITATBIDR bit values correspond to the physical state of the output pins.

The TRCITATBIDR can be accessed through the internal memory-mapped interface and the external debug interface, offset 0xEE4.

13.8.50 Integration Instruction ATB Data Register

The TRCITIDATAR characteristics are:

- Purpose** Sets the state of the **ATDATAMn** output pins shown in [Table 13-53 on page 13-57](#).
- Usage constraints**
- Available when bit[0] of TRCITCTRL is set to 1.
 - The value of the register sets the signals on the output pins when the register is written.
- Configurations** Available in all configurations.
- Attributes** See the register summary in [Table 13-3 on page 13-10](#).

[Figure 13-52 on page 13-57](#) shows the TRCITIDATAR bit assignments.

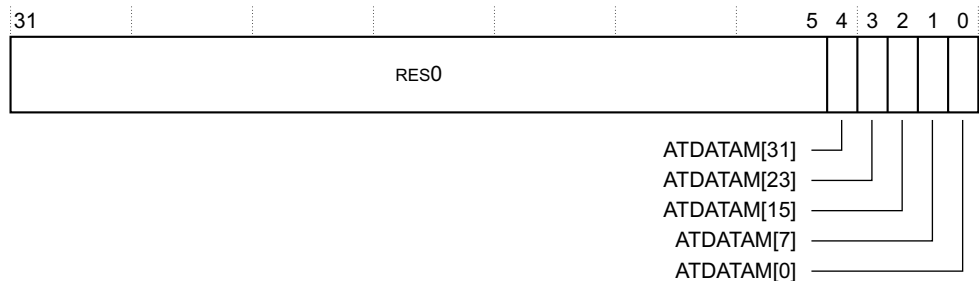

Figure 13-52 TRCITIDATAR bit assignments

Table 13-53 shows the TRCITIDATAR bit assignments.

Table 13-53 TRCITIDATAR bit assignments

Bits	Name	Function
[31:5]	-	Reserved, RES0
[4]	ATDATAM[31]	Drives the ATDATAM[31] output ^a
[3]	ATDATAM[23]	Drives the ATDATAM[23] output ^a
[2]	ATDATAM[15]	Drives the ATDATAM[15] output ^a
[1]	ATDATAM[7]	Drives the ATDATAM[7] output ^a
[0]	ATDATAM[0]	Drives the ATDATAM[0] output ^a

a. When a bit is set to 0, the corresponding output pin is LOW. When a bit is set to 1, the corresponding output pin is HIGH. The TRCITDDATAR bit values correspond to the physical state of the output pins.

The TRCITIDATAR can be accessed through the internal memory-mapped interface and the external debug interface, offset 0xEEC.

13.8.51 Integration Instruction ATB In Register

The TRCITIATBINR characteristics are:

- Purpose** Reads the state of the input pins shown in [Table 13-54](#).
- Usage constraints**
 - Available when bit[0] of TRCITCTRL is set to 1.
 - The values of the register bits depend on the signals on the input pins when the register is read.
- Configurations** Available in all configurations.
- Attributes** See the register summaries in [Table 13-3 on page 13-10](#).

[Figure 13-53](#) shows the TRCITIATBINR bit assignments.

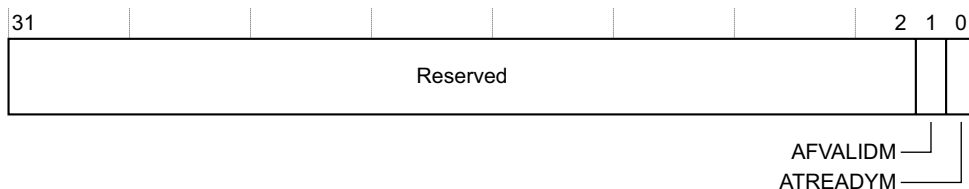

Figure 13-53 TRCITIATBINR bit assignments

[Table 13-54](#) shows the TRCITIATBINR bit assignments.

Table 13-54 TRCITIATBINR bit assignments

Bits	Name	Function
[31:2]	-	Reserved. Read undefined.
[1]	AFVALIDM	Returns the value of the AFVALIDM _n input pin ^a .
[0]	ATREADYM	Returns the value of the ATREADYM _n input pin ^a .

- a. When an input pin is LOW, the corresponding register bit is 0.
When an input pin is HIGH, the corresponding register bit is 1.
The TRCITIATBINR bit values always correspond to the physical state of the input pins.

The TRCITIATBINR can be accessed through the internal memory-mapped interface and the external debug interface, offset 0xEF4.

13.8.52 Integration Instruction ATB Out Register

The TRCITIATBOUTr characteristics are:

- Purpose** Sets the state of the output pins shown in [Table 13-55](#).
- Usage constraints**
- Available when bit[0] of TRCITCTRL is set to 1.
 - The value of the register sets the signals on the output pins when the register is written.
- Configurations** Available in all configurations.
- Attributes** See the register summaries in [Table 13-3 on page 13-10](#).

[Figure 13-54](#) shows the TRCITIATBOUTr bit assignments.



Figure 13-54 TRCITIATBOUTr bit assignments

[Table 13-55](#) shows the TRCITIATBOUTr bit assignments.

Table 13-55 TRCITIATBOUTr bit assignments

Bits	Name	Function
[31:10]	-	Reserved. Read undefined.
[9:8]	BYTES	Drives the ATBYTESMn[1:0] output pins ^a .
[7:2]	-	Reserved. Read undefined.
[1]	AFREADY	Drives the AFREADYMn output pin ^a .
[0]	ATVALID	Drives the ATVALIDMn output pin ^a .

- a. When a bit is set to 0, the corresponding output pin is LOW.
When a bit is set to 1, the corresponding output pin is HIGH.
The TRCITIATBOUTr bit values always correspond to the physical state of the output pins.

The TRCITIATBOUTr can be accessed through the internal memory-mapped interface and the external debug interface, offset 0xEFC.

13.8.53 Integration Mode Control Register

The TRCITCTRL characteristics are:

- Purpose** Enables topology detection or integration testing, by putting the ETM trace unit into integration mode.
- Usage constraints** ARM recommends that you perform a debug reset after using integration mode.
- Configurations** Available in all configurations.

Attributes See the register summary in [Table 13-3 on page 13-10](#).

[Figure 13-55](#) shows the TRCITCTRL bit assignments.

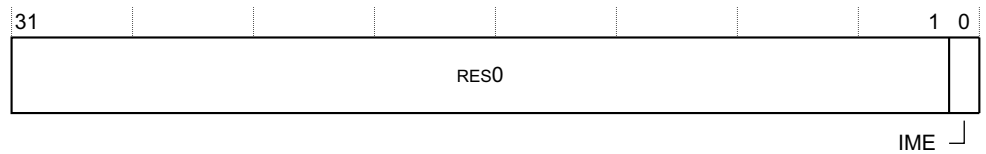

Figure 13-55 TRCITCTRL bit assignments

[Table 13-56](#) shows the TRCITCTRL bit assignments.

Table 13-56 TRCITCTRL bit assignments

Bits	Name	Function
[31:1]	-	Reserved, RES0.
[0]	IME	Integration mode enable bit. The possible values are: 0 The trace unit is not in integration mode. 1 The trace unit is in integration mode. This mode enables: <ul style="list-style-type: none"> A debug agent to perform topology detection. SoC test software to perform integration testing.

The TRCITCTRL can be accessed through the internal memory-mapped interface and the external debug interface, offset 0xF00.

13.8.54 Claim Tag Set Register

The TRCCLAIMSET characteristics are:

Purpose Sets bits in the claim tag and determines the number of claim tag bits implemented.

Usage constraints There are no usage constraints.

Configurations Available in all configurations.

Attributes See the register summary in [Table 13-3 on page 13-10](#).

[Figure 13-56](#) shows the TRCCLAIMSET bit assignments.

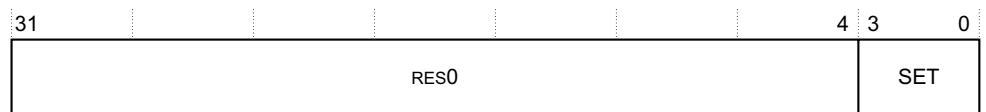

Figure 13-56 TRCCLAIMSET bit assignments

Table 13-57 shows the TRCCLAIMSET bit assignments.

Table 13-57 TRCCLAIMSET bit assignments

Bits	Name	Function
[31:4]	-	Reserved, RES0.
[3:0]	SET	On reads, for each bit: 0 Claim tag bit is not implemented. 1 Claim tag bit is implemented. On writes, for each bit: 0 Has no effect. 1 Sets the relevant bit of the claim tag.

The TRCCLAIMSET can be accessed through the internal memory-mapped interface and the external debug interface, offset 0xFA0.

13.8.55 Claim Tag Clear Register

The TRCCLAIMCLR characteristics are:

Purpose Clears bits in the claim tag and determines the current value of the claim tag.

Usage constraints There are no usage constraints.

Configurations Available in all configurations.

Attributes See the register summary in Table 13-3 on page 13-10.

Figure 13-57 shows the TRCCLAIMCLR bit assignments.

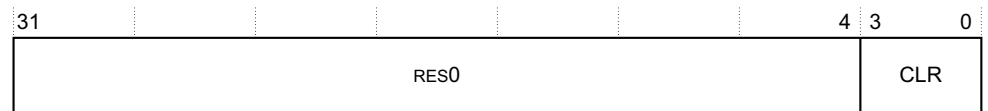

Figure 13-57 TRCCLAIMCLR bit assignments

Table 13-58 shows the TRCCLAIMCLR bit assignments.

Table 13-58 TRCCLAIMCLR bit assignments

Bits	Name	Function
[31:4]	-	Reserved, RES0.
[3:0]	CLR	On reads, for each bit: 0 Claim tag bit is not set. 1 Claim tag bit is set. On writes, for each bit: 0 Has no effect. 1 Clears the relevant bit of the claim tag.

The TRCCLAIMCLR can be accessed through the internal memory-mapped interface and the external debug interface, offset 0xFA4.

13.8.56 Device Affinity Register 0

The TRCDEVAFF0 characteristics are:

Purpose Provides an additional core identification mechanism for scheduling purposes in a cluster.

TRCDEVAFF0 is a read-only copy of MPIDR accessible from the external debug interface.

Usage constraints This register is accessible as follows:

EL0 (NS)	EL0 (S)	EL1 (NS)	EL1 (S)	EL2	EL3 (SCR.NS = 1)	EL3 (SCR.NS = 0)
-	-	RO	RO	RO	RO	RO

Configurations The TRCDEVAFF0 is:

- Architecturally mapped to the AArch64 MPIDR_EL1[31:0] register. See [Multiprocessor Affinity Register on page 4-15](#).
- Architecturally mapped to external TRCDEVAFF0 register.

There is one copy of this register that is used in both Secure and Non-secure states.

Attributes TRCDEVAFF0 is a 32-bit register.

Figure 13-58 shows the TRCDEVAFF0 bit assignments.

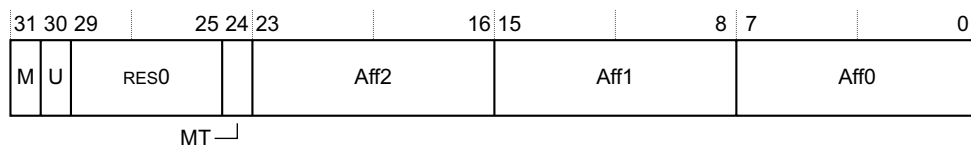

Figure 13-58 TRCDEVAFF0 bit assignments

Table 13-59 shows the TRCDEVAFF0 bit assignments.

Table 13-59 TRCDEVAFF0 bit assignments

Bits	Name	Function
[31]	M	RES1.
[30]	U	Indicates a single core system, as distinct from core 0 in a cluster. This value is: 0 Core is part of a cluster.
[29:25]	-	Reserved, RES0.
[24]	MT	Indicates whether the lowest level of affinity consists of logical cores that are implemented using a multi-threading type approach. This value is: 0 Performance of cores at the lowest affinity level is largely independent.
[23:16]	Aff2	Affinity level 2. Second highest level affinity field. Indicates the value read in the CLUSTERIDAFF2 configuration signal.
[15:8]	Aff1	Affinity level 1. Third highest level affinity field. Indicates the value read in the CLUSTERIDAFF1 configuration signal.
[7:0]	Aff0	Affinity level 0. Lowest level affinity field. Indicates the core number in the Cortex-A53 processor. The possible values are: 0x0 A processor with one core only. 0x0, 0x1 A cluster with two cores. 0x0, 0x1, 0x2 A cluster with three cores. 0x0, 0x1, 0x2, 0x3 A cluster with four cores.

To access the TRCDEVAFF0:

MRC p15,0,<Rt>,c0,c0,5 ; Read TRCDEVAFF0 into Rt

Register access is encoded as follows:

Table 13-60 TRCDEVAFF0 access encoding

coproc	opc1	CRn	CRm	opc2
1111	000	0000	0000	101

The TRCDEVAFF0 can be accessed through the internal memory-mapped interface and the external debug interface, offset 0xFA8.

13.8.57 Device Affinity Register 1

The TRCDEVAFF1 characteristics are:

Purpose	The value is a read-only copy of MPIDR_EL1[63:32] as seen from EL3, unaffected by VMPIDR_EL2.
Usage constraints	Accessible only from the memory-mapped interface or the external debugger interface.
Configurations	Available in all configurations.
Attributes	TRCDEVAFF1 is a 32-bit RO management register. For the Cortex-A53 processor, MPIDR_EL1[63:32] is RES0.

See the register summary in [Table 13-3 on page 13-10](#).

The TRCDEVAFF1 can be accessed through the internal memory-mapped interface and the external debug interface, offset 0xFAC.

13.8.58 Software Lock Access Register

The TRCLAR characteristics are:

- Purpose** Controls access to registers using the memory-mapped interface, when **PADDRDBG31** is LOW.
When the software lock is set, write accesses using the memory-mapped interface to all ETM trace unit registers are ignored, except for write accesses to the TRCLAR.
When the software lock is set, read accesses of TRCPDSR do not change the TRCPDSR.STICKYPD bit. Read accesses of all other registers are not affected.
- Usage constraints** Accessible only from the memory-mapped interface.
- Configurations** Available in all configurations.
- Attributes** See the register summary in [Table 13-3 on page 13-10](#).

[Figure 13-59](#) shows the TRCLAR bit assignments.

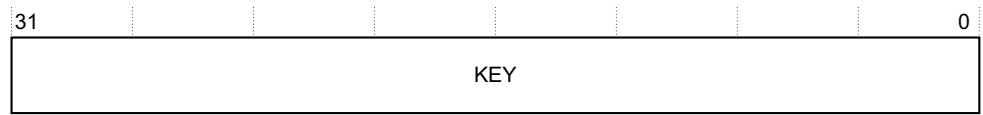

Figure 13-59 TRCLAR bit assignments

[Table 13-61](#) shows the TRCLAR bit assignments.

Table 13-61 TRCLAR bit assignments

Bits	Name	Function
[31:0]	KEY	Software lock key value: 0xC5ACCE55 Clear the software lock. All other write values set the software lock.

The TRCLAR can be accessed through the internal memory-mapped interface and the external debug interface, offset 0xFB0.

13.8.59 Software Lock Status Register

The TRCLSR characteristics are:

- Purpose** Determines whether the software lock is implemented, and indicates the current status of the software lock.
- Usage constraints** Accessible only from the memory-mapped interface or the external debugger interface.
- Configurations** Available in all configurations.
- Attributes** See the register summary in [Table 13-3 on page 13-10](#).

Figure 13-60 shows the TRCLSR bit assignments.

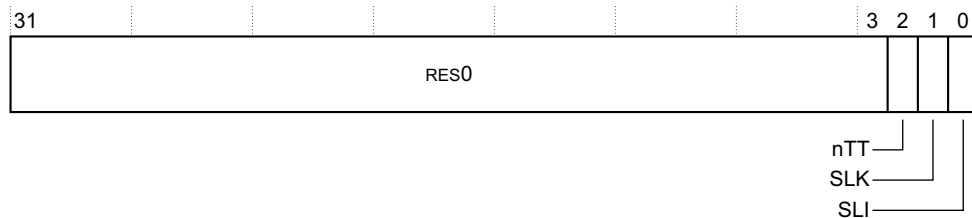

Figure 13-60 TRCLSR bit assignments

Table 13-62 shows the TRCLSR bit assignments.

Table 13-62 TRCLSR bit assignments

Bits	Name	Function
[31:3]	-	Reserved, RES0.
[2]	nTT	Indicates size of TRCLAR: 0 TRCLAR is always 32 bits.
[1]	SLK	Software lock status: 0 Software lock is clear. 1 Software lock is set.
[0]	SLI	Indicates whether the software lock is implemented on this interface. 1 Software lock is implemented on this interface.

The TRCLSR can be accessed through the internal memory-mapped interface and the external debug interface, offset 0xFB4.

13.8.60 Authentication Status Register

The TRCAUTHSTATUS characteristics are:

- Purpose** Indicates the current level of tracing permitted by the system.
- Usage constraints** There are no usage constraints.
- Configurations** Available in all configurations.
- Attributes** See the register summary in [Table 13-3 on page 13-10](#)

Figure 13-61 shows the TRCAUTHSTATUS bit assignments.

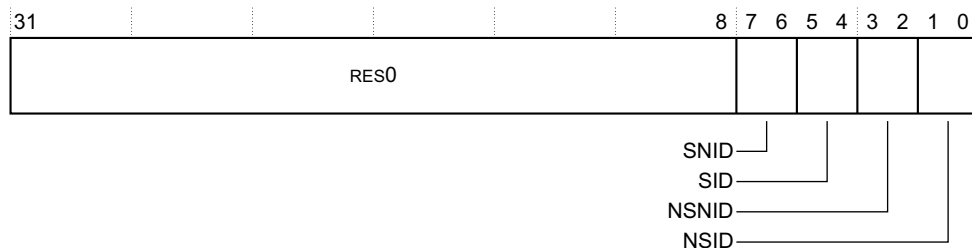

Figure 13-61 TRCAUTHSTATUS bit assignments

Table 13-63 shows the TRCAUTHSTATUS bit assignments.

Table 13-63 TRCAUTHSTATUS bit assignments

Bits	Name	Function
[31:8]	-	Reserved, RES0.
[7:6]	SNID	Secure Non-invasive Debug: b10 Secure Non-invasive Debug implemented but disabled. b11 Secure Non-invasive Debug implemented and enabled.
[5:4]	SID	Secure Invasive Debug: b00 Secure Invasive Debug is not implemented.
[3:2]	NSNID	Non-secure Non-invasive Debug: b10 Non-secure Non-invasive Debug implemented but disabled, NIDEN =0. b11 Non-secure Non-invasive Debug implemented and enabled, NIDEN =1.
[1:0]	NSID	Non-secure Invasive Debug: b00 Non-secure Invasive Debug is not implemented.

The TRCAUTHSTATUS can be accessed through the internal memory-mapped interface and the external debug interface, offset 0xFB8.

13.8.61 Device Architecture Register

The TRCDEVARCH characteristics are:

- Purpose** Identifies the ETM trace unit as an ETMv4 component.
- Usage constraints** There are no usage constraints.
- Configurations** Available in all configurations.
- Attributes** See the register summary in Table 13-3 on page 13-10.

Figure 13-62 shows the TRCDEVARCH bit assignments.

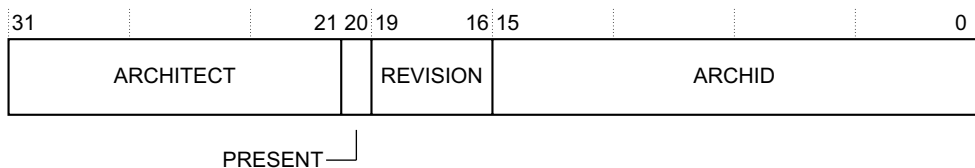

Figure 13-62 TRCDEVARCH bit assignments

Table 13-64 shows the TRCDEVARCH bit assignments.

Table 13-64 TRCDEVARCH bit assignments

Bits	Name	Function
[31:21]	ARCHITECT	Defines the architect of the component: 0x4 ARM JEP continuation. 0x3B ARM JEP 106 code.
[20]	PRESENT	Indicates the presence of this register: b1 Register is present.
[19:16]	REVISION	Architecture revision: b0000 Architecture revision 0.
[15:0]	ARCHID	Architecture ID: 0x4A13 ETMv4 component.

The TRCDEVARCH can be accessed through the internal memory-mapped interface and the external debug interface, offset 0xFBC.

13.8.62 Device ID Register

The TRCDEVID characteristics are:

- Purpose** Indicates the capabilities of the ETM trace unit.
- Usage constraints** There are no usage constraints.
- Configurations** Available in all configurations.
- Attributes** See the register summary in [Table 13-3 on page 13-10](#).

Figure 13-63 shows the TRCDEVID bit assignments.

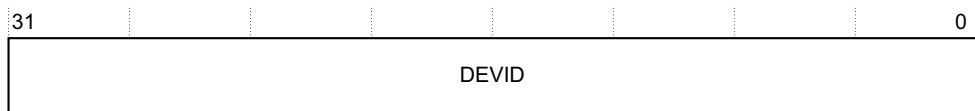

Figure 13-63 TRCDEVID bit assignments

Table 13-65 shows the TRCDEVID bit assignments.

Table 13-65 TRCDEVID bit assignments

Bits	Name	Function
[31:0]	DEVID	RAZ. There are no component-defined capabilities.

The TRCDEVID can be accessed through the internal memory-mapped interface and the external debug interface, offset 0xFC8.

13.8.63 Device Type Register

The TRCDEVTYPE characteristics are:

- Purpose** Indicates the type of the component.

Usage constraints Accessible only from the memory-mapped interface or the external debugger interface.

Configurations Available in all configurations.

Attributes See the register summary in [Table 13-3](#) on page 13-10.

[Figure 13-64](#) shows the TRCDEVTYPE bit assignments.

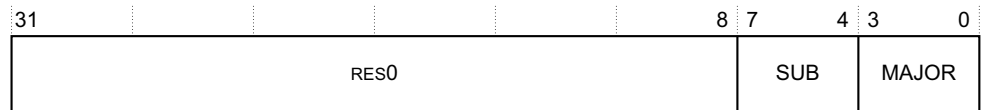

Figure 13-64 TRCDEVTYPE bit assignments

[Table 13-66](#) shows the TRCDEVTYPE bit assignments.

Table 13-66 TRCDEVTYPE bit assignments

Bits	Name	Function
[31:8]	-	Reserved, RES0.
[7:4]	SUB	The sub-type of the component: b0001 Processor trace.
[3:0]	MAJOR	The main type of the component: b0011 Trace source.

The TRCDEVTYPE can be accessed through the internal memory-mapped interface and the external debug interface, offset 0xFCC.

13.8.64 Peripheral Identification Registers

The Peripheral Identification Registers provide standard information required for all CoreSight components. They are a set of eight registers, listed in register number order in [Table 13-67](#).

Table 13-67 Summary of the Peripheral ID Registers

Register	Value	Offset
Peripheral ID4	0x04	0xFD0
Peripheral ID5	0x00	0xFD4
Peripheral ID6	0x00	0xFD8
Peripheral ID7	0x00	0xFDC
Peripheral ID0	0x5D	0xFE0
Peripheral ID1	0xB9	0xFE4
Peripheral ID2	0x2B	0xFE8
Peripheral ID3	0x00	0xFEC

Only bits[7:0] of each Peripheral ID Register are used, with bits[31:8] reserved. Together, the eight Peripheral ID Registers define a single 64-bit Peripheral ID.

The Peripheral ID registers are:

- [Peripheral Identification Register 0](#).
- [Peripheral Identification Register 1](#).
- [Peripheral Identification Register 2](#) on page 13-70.
- [Peripheral Identification Register 3](#) on page 13-71.
- [Peripheral Identification Register 4](#) on page 13-71.
- [Peripheral Identification Register 5-7](#) on page 13-72.

Peripheral Identification Register 0

The TRCPIDR0 characteristics are:

- Purpose** Provides information to identify a trace component.
- Usage constraints**
- Only bits[7:0] are valid.
 - Accessible only from the memory-mapped interface or the external debugger interface, offset 0xFE0.
- Configurations** Available in all implementations.
- Attributes** TRCPIDR0 is a 32-bit RO management register.
See the register summary in [Table 13-3](#) on page 13-10.

[Figure 13-65](#) shows the TRCPIDR0 bit assignments.

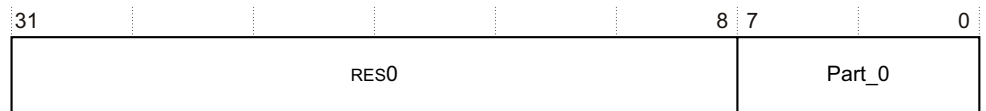

Figure 13-65 TRCPIDR0 bit assignments

[Table 13-68](#) shows the TRCPIDR0 bit assignments.

Table 13-68 TRCPIDR0 bit assignments

Bits	Name	Function
[31:8]	-	Reserved, RES0.
[7:0]	Part_0	0x5D Least significant byte of the ETM trace unit part number.

Peripheral Identification Register 1

The TRCPIDR1 characteristics are:

- Purpose** Provides information to identify a trace component.
- Usage constraints**
- Only bits[7:0] are valid.
 - Accessible only from the memory-mapped interface or the external debugger interface.
- Configurations** Available in all implementations.
- Attributes** TRCPIDR1 is a 32-bit RO management register.
See the register summary in [Table 13-3](#) on page 13-10.

[Figure 13-66](#) on page 13-70 shows the TRCPIDR1 bit assignments.

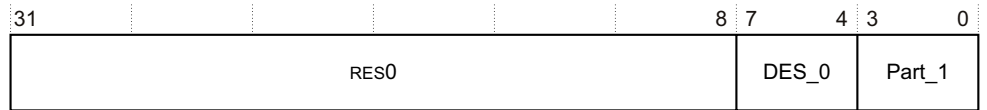

Figure 13-66 TRCPIDR1 bit assignments

Table 13-69 shows the TRCPIDR1 bit assignments.

Table 13-69 TRCPIDR1 bit assignments

Bits	Name	Function
[31:8]	-	Reserved, RES0.
[7:4]	DES_0	0xB ARM Limited. This is bits [3:0] of JEP106 ID code.
[3:0]	Part_1	0x9 Most significant four bits of the ETM trace unit part number.

The TRCPIDR1 can be accessed through the internal memory-mapped interface and the external debug interface, offset 0xFE4.

Peripheral Identification Register 2

The TRCPIDR2 characteristics are:

- Purpose** Provides information to identify a trace component.
- Usage constraints**
 - Only bits[7:0] are valid.
 - Accessible only from the memory-mapped interface or the external debugger interface.
- Configurations** Available in all implementations.
- Attributes** TRCPIDR2 is a 32-bit RO management register.
See the register summary in [Table 13-3 on page 13-10](#).

Figure 13-67 shows the TRCPIDR2 bit assignments.

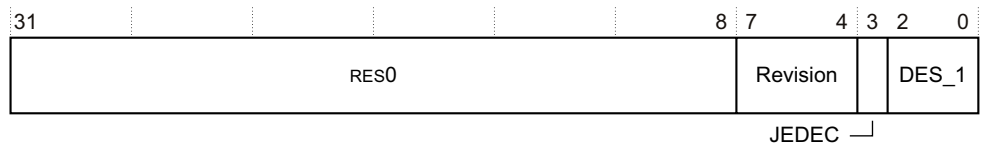

Figure 13-67 TRCPIDR2 bit assignments

Table 13-70 shows the TRCPIDR2 bit assignments.

Table 13-70 TRCPIDR2 bit assignments

Bits	Name	Function
[31:8]	-	Reserved, RES0.
[7:4]	Revision	0x2 r0p2.
[3]	JEDEC	0b1 RES1. Indicates a JEP106 identity code is used.
[2:0]	DES_1	0b011 ARM Limited. This is bits [6:4] of JEP106 ID code.

The TRCPIDR2 can be accessed through the internal memory-mapped interface and the external debug interface, offset 0xFE8.

Peripheral Identification Register 3

The TRCPIDR3 characteristics are:

- Purpose** Provides information to identify a trace component.
- Usage constraints**
 - Only bits[7:0] are valid.
 - Accessible only from the memory-mapped interface or the external debugger interface.
- Configurations** Available in all implementations.
- Attributes** TRCPIDR3 is a 32-bit RO management register.
See the register summary in [Table 13-3 on page 13-10](#).

[Figure 13-68](#) shows the TRCPIDR3 bit assignments.

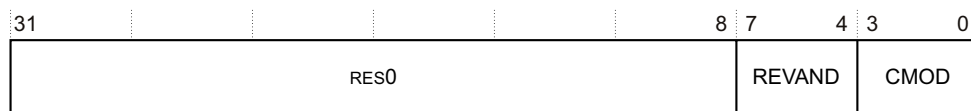

Figure 13-68 TRCPIDR3 bit assignments

[Table 13-71](#) shows the TRCPIDR3 bit assignments.

Table 13-71 TRCPIDR3 bit assignments

Bits	Name	Value	Function
[31:8]	-		Reserved, RES0.
[7:4]	REVAND	0x0	Part minor revision.
[3:0]	CMOD	0x0	Not customer modified.

The TRCPIDR3 can be accessed through the internal memory-mapped interface and the external debug interface, offset 0xFEC.

Peripheral Identification Register 4

The TRCPIDR4 characteristics are:

- Purpose** Provides information to identify a trace component.
- Usage constraints**
 - Only bits[7:0] are valid.
 - Accessible only from the memory-mapped interface or the external debugger interface.
- Configurations** Available in all implementations.
- Attributes** TRCPIDR4 is a 32-bit RO management register.
See the register summary in [Table 13-3 on page 13-10](#).

[Figure 13-69 on page 13-72](#) shows the TRCPIDR4 bit assignments.

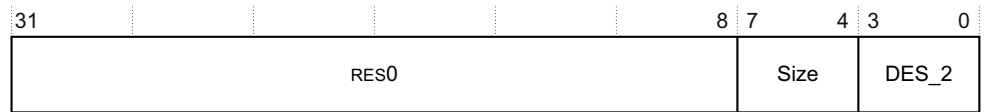

Figure 13-69 TRCPIDR4 bit assignments

Table 13-72 shows the TRCPIDR4 bit assignments.

Table 13-72 TRCPIDR4 bit assignments

Bits	Name	Function
[31:8]	-	Reserved, RES0.
[7:4]	Size	0x0 Size of the component. Log2 the number of 4KB pages from the start of the component to the end of the component ID registers.
[3:0]	DES_2	0x4 ARM Limited. This is bits [3:0] of the JEP106 continuation code.

The TRCPIDR4 can be accessed through the internal memory-mapped interface and the external debug interface, offset 0xFD0.

Peripheral Identification Register 5-7

No information is held in the Peripheral ID5, Peripheral ID6 and Peripheral ID7 Registers. They are reserved for future use and are RES0.

13.8.65 Component Identification Registers

There are four read-only Component Identification Registers, Component ID0 to Component ID3. Table 13-73 shows these registers.

Table 13-73 Summary of the Component Identification Registers

Register	Value	Offset
Component ID0	0x0D	0xFF0
Component ID1	0x90	0xFF4
Component ID2	0x05	0xFF8
Component ID3	0xB1	0xFFC

The Component Identification Registers identify ETM trace unit as a CoreSight component.

The Component ID registers are:

- [Component Identification Register 0](#).
- [Component Identification Register 1](#) on page 13-73.
- [Component Identification Register 2](#) on page 13-74.
- [Component Identification Register 3](#) on page 13-74.

Component Identification Register 0

The TRCCIDR0 characteristics are:

Purpose Provides information to identify a trace component.

- Usage constraints**
- Only bits[7:0] are valid.
 - Accessible only from the memory-mapped interface or the external debugger interface.

Configurations Available in all implementations.

Attributes See the register summary in [Table 13-3 on page 13-10](#).

[Figure 13-70](#) shows the TRCCIDR0 bit assignments.

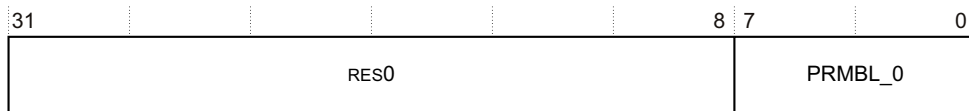

Figure 13-70 TRCCIDR0 bit assignments

[Table 13-74](#) shows the TRCCIDR0 bit assignments.

Table 13-74 TRCCIDR0 bit assignments

Bits	Name	Function
[31:8]	-	Reserved, RES0.
[7:0]	PRMBL_0	0x0D Preamble byte 0.

The TRCCIDR0 can be accessed through the internal memory-mapped interface and the external debug interface, offset 0xFF0.

Component Identification Register 1

The TRCCIDR1 characteristics are:

Purpose Provides information to identify a trace component.

- Usage constraints**
- Only bits[7:0] are valid.
 - Accessible only from the memory-mapped interface or the external debugger interface.

Configurations Available in all implementations.

Attributes See the register summary in [Table 13-3 on page 13-10](#).

[Figure 13-71](#) shows the TRCCIDR1 bit assignments.

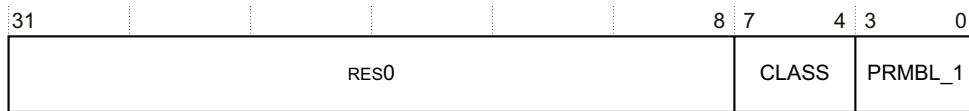

Figure 13-71 TRCCIDR1 bit assignments

Table 13-75 shows the TRCCIDR1 bit assignments.

Table 13-75 TRCCIDR1 bit assignments

Bits	Name	Function
[31:8]	-	Reserved, RES0
[7:4]	CLASS	0x9 Debug component
[3:0]	PRMBL_1	0x0 Preamble byte 1

The TRCCIDR1 can be accessed through the internal memory-mapped interface and the external debug interface, offset 0xFF4.

Component Identification Register 2

The TRCCIDR2 characteristics are:

Purpose	Provides information to identify a CTI component.
Usage constraints	<ul style="list-style-type: none"> Only bits[7:0] are valid. Accessible only from the memory-mapped interface or the external debugger interface.
Configurations	Available in all implementations.
Attributes	See the register summary in Table 13-3 on page 13-10 .

Figure 13-72 shows the TRCCIDR2 bit assignments.

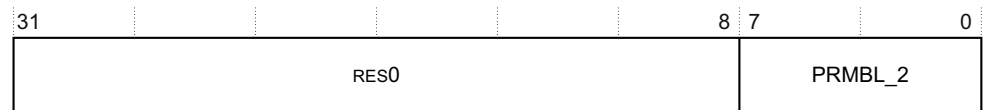

Figure 13-72 TRCCIDR2 bit assignments

Table 13-76 shows the TRCCIDR2 bit assignments.

Table 13-76 TRCCIDR2 bit assignments

Bits	Name	Function
[31:8]	-	Reserved, RES0.
[7:0]	PRMBL_2	0x05 Preamble byte 2.

The TRCCIDR2 can be accessed through the internal memory-mapped interface and the external debug interface, offset 0xFF8.

Component Identification Register 3

The TRCCIDR3 characteristics are:

Purpose	Provides information to identify a trace component.
Usage constraints	<ul style="list-style-type: none"> Only bits[7:0] are valid. Accessible only from the memory-mapped interface or the external debugger interface.

Configurations Available in all implementations.

Attributes See the register summary in [Table 13-3 on page 13-10](#).

[Figure 13-73](#) shows the TRCCIDR3 bit assignments.

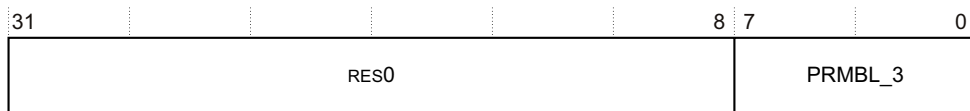

Figure 13-73 TRCCIDR3 bit assignments

[Table 13-77](#) shows the TRCCIDR3 bit assignments.

Table 13-77 TRCCIDR3 bit assignments

Bits	Name	Function
[31:8]	-	Reserved, RES0.
[7:0]	PRMBL_3	0xB1 Preamble byte 3.

The TRCCIDR3 can be accessed through the internal memory-mapped interface and the external debug interface, offset 0xFFC.

13.9 Interaction with debug and performance monitoring unit

This section describes:

- [Interaction with the performance monitoring unit.](#)
- [Effect of debug double lock on trace register access.](#)

13.9.1 Interaction with the performance monitoring unit

The Cortex-A53 processor includes a *Performance Monitoring Unit* (PMU) that enables events, such as cache misses and instructions executed, to be counted over a period of time. See [Chapter 12 Performance Monitor Unit](#) for more information. This section describes how the PMU and ETM trace unit function together.

Use of PMU events by the ETM trace unit

All PMU architectural events are available to the ETM trace unit through the extended input facility. See the *ARM® Architecture Reference Manual ARMv8, for ARMv8-A architecture profile* for more information on PMU events.

The ETM trace unit uses four extended external input selectors to access the PMU events. Each selector can independently select one of the PMU events, that are then active for the cycles where the relevant events occur. These selected events can then be accessed by any of the event registers within the ETM trace unit. [Table 12-28 on page 12-36](#) describes the PMU events.

13.9.2 Effect of debug double lock on trace register access

All trace register accesses through the memory-mapped and external debug interfaces behave as if the processor power domain is powered down when debug double lock is set. For more information on debug double lock, see the *ARM® Architecture Reference Manual ARMv8, for ARMv8-A architecture profile*.

Chapter 14

Cross Trigger

This chapter describes the cross trigger interfaces for the Cortex-A53 processor. It contains the following sections:

- *About the cross trigger* on page 14-2.
- *Trigger inputs and outputs* on page 14-3.
- *Cortex-A53 CTM* on page 14-4.
- *Cross trigger register summary* on page 14-5.
- *Cross trigger register descriptions* on page 14-8.

14.1 About the cross trigger

The Cortex-A53 processor has a single external cross trigger channel interface. This external interface is connected to the CoreSight *Cross Trigger Interface* (CTI) interface corresponding to each core through a simplified *Cross Trigger Matrix* (CTM). A number of *Embedded Cross Trigger* (ECT) trigger inputs and trigger outputs are connected between debug components in the Cortex-A53 processor and CoreSight CTI blocks.

The CTI enables the debug logic, ETM trace unit, and PMU, to interact with each other and with other CoreSight components. This is called cross triggering. For example, you configure the CTI to generate an interrupt when the ETM trace unit trigger event occurs.

Figure 14-1 shows the debug system components and the available trigger inputs and trigger outputs.

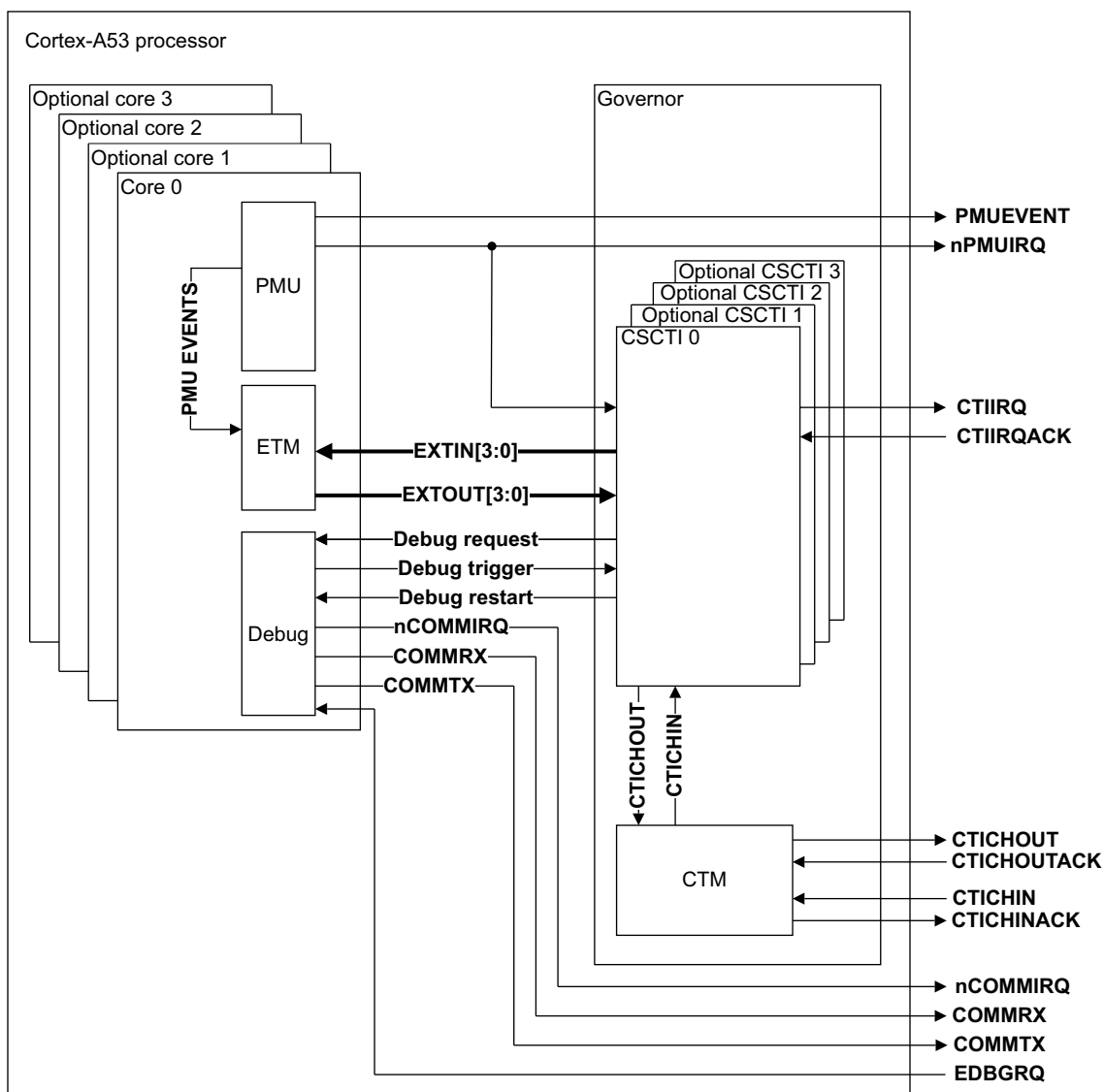

Figure 14-1 Debug system components

14.2 Trigger inputs and outputs

This section describes the trigger inputs and outputs that are available to the CTI.

Table 14-1 shows the CTI inputs.

Table 14-1 Trigger inputs

CTI input	Name	Description
0	DBGTRIGGER , pulsed	Pulsed on entry to debug state
1	PMUIRQ ^a	PMU generated interrupt
2	-	-
3	-	-
4	EXTOUT[0]	ETM trace unit external output
5	EXTOUT[1]	ETM trace unit external output
6	EXTOUT[2]	ETM trace unit external output
7	EXTOUT[3]	ETM trace unit external output

a. This signal is the same as **nPMUIRQ** with inverted polarity.

Table 14-2 shows the CTI outputs.

Table 14-2 Trigger outputs

CTI output	Name	Description
0	EDBGRQ	Causes the processor to enter debug state
1	DBGRESTART	Causes the processor to exit debug state
2	CTHRQ	CTI interrupt
3	-	-
4	EXTIN[0]	ETM trace unit external input
5	EXTIN[1]	ETM trace unit external input
6	EXTIN[2]	ETM trace unit external input
7	EXTIN[3]	ETM trace unit external input

14.3 Cortex-A53 CTM

The CoreSight CTI channel signals from all the cores are combined using a simplified *Cross Trigger Matrix* (CTM) block so that a single cross trigger channel interface is presented in the Cortex-A53 processor. This module can combine up to four internal channel interfaces corresponding to each core along with one external channel interface.

In the simplified CTM, external channel output is driven by the OR output of all internal channel outputs. Each internal channel input is driven by the OR output of internal channel outputs of all other CTIs in addition to the external channel input.

14.4 Cross trigger register summary

This section describes the cross trigger registers in the Cortex-A53 processor. These registers are accessed through the internal memory-mapped interface or the external debug interface.

Table 14-3 gives a summary of the Cortex-A53 cross trigger registers. For those registers not described in this chapter, see the *ARM® Architecture Reference Manual ARMv8, for ARMv8-A architecture profile*.

Table 14-3 Cross trigger register summary

Offset	Name	Type	Description
0x000	CTICONTROL	RW	CTI Control Register
0x000–0x00C	-	-	Reserved
0x010	CTIINTACK	WO	CTI Output Trigger Acknowledge Register
0x014	CTIAPPSET	RW	CTI Application Trigger Set Register
0x018	CTIAPPCLEAR	WO	CTI Application Trigger Clear Register
0x01C	CTIAPPULSE	WO	CTI Application Pulse Register
0x020	CTIINEN0	RW	CTI Input Trigger to Output Channel Enable Registers
0x024	CTIINEN1	RW	
0x028	CTIINEN2	RW	
0x02C	CTIINEN3	RW	
0x030	CTIINEN4	RW	
0x034	CTIINEN5	RW	
0x038	CTIINEN6	RW	
0x03C	CTIINEN7	RW	
0x040–0x09C	-	-	Reserved
0x0A0	CTIOUTEN0	RW	CTI Input Channel to Output Trigger Enable Registers
0x0A4	CTIOUTEN1	RW	
0x0A8	CTIOUTEN2	RW	
0x0AC	CTIOUTEN3	RW	
0x0B0	CTIOUTEN4	RW	
0x0B4	CTIOUTEN5	RW	
0x0B8	CTIOUTEN6	RW	
0x0BC	CTIOUTEN7	RW	
0x0C0–0x12C	-	-	Reserved
0x130	CTITRIGINSTATUS	RO	CTI Trigger In Status Register
0x134	CTITRIGOUTSTATUS	RO	CTI Trigger Out Status Register
0x138	CTICHINSTATUS	RO	CTI Channel In Status Register

Table 14-3 Cross trigger register summary (continued)

Offset	Name	Type	Description
0x13C	CTICHOUTSTATUS	RO	CTI Channel Out Status Register
0x140	CTIGATE	RW	CTI Channel Gate Enable Register
0x144	ASICCTL	RW	CTI External Multiplexer Control Register
0x148-0xF7C	-	-	Reserved
0xF00	CTIITCTRL	RW	<i>CTI Integration Mode Control Register on page 14-9</i>
0xF04-0xFA4	-	-	Reserved
0xFA0	CTICLAIMSET	RW	CTI Claim Tag Set Register
0xFA4	CTICLAIMCLR	RW	CTI Claim Tag Clear Register
0xFA8	CTIDEVAFF0	RO	CTI Device Affinity Register 0
0xFAC	CTIDEVAFF1	RO	CTI Device Affinity Register 1
0xFB0	CTILAR	WO	CTI Lock Access Register
0xFB4	CTILSR	RO	CTI Lock Status Register
0xFB8	CTIAUTHSTATUS	RO	CTI Authentication Status Register
0xFBC	CTIDEVARCH	RO	CTI Device Architecture Register
0xFC0	CTIDEVID2	RO	CTI Device ID Register 2
0xFC4	CTIDEVID1	RO	CTI Device ID Register 1
0xFC8	CTIDEVID	RO	<i>CTI Device Identification Register on page 14-8</i>
0xFCC	CTIDEVTYPE	RO	CTI Device Type Register
0xFD0	CTIPIDR4	RO	<i>Peripheral Identification Register 4 on page 14-13</i>
0xFD4	CTIPIDR5	RO	<i>Peripheral Identification Register 5-7 on page 14-14</i>
0xFD8	CTIPIDR6	RO	
0xFDC	CTIPIDR7	RO	
0xFE0	CTIPIDR0	RO	<i>Peripheral Identification Register 0 on page 14-10</i>
0xFE4	CTIPIDR1	RO	<i>Peripheral Identification Register 1 on page 14-11</i>
0xFE8	CTIPIDR2	RO	<i>Peripheral Identification Register 2 on page 14-12</i>
0xFEC	CTIPIDR3	RO	<i>Peripheral Identification Register 3 on page 14-12</i>
0xFF0	CTICIDR0	RO	<i>Component Identification Register 0 on page 14-14</i>
0xFF4	CTICIDR1	RO	<i>Component Identification Register 1 on page 14-15</i>
0xFF8	CTICIDR2	RO	<i>Component Identification Register 2 on page 14-16</i>
0xFFC	CTICIDR3	RO	<i>Component Identification Register 3 on page 14-17</i>

14.4.1 External register access permissions

External access permission to the cross trigger registers is subject to the conditions at the time of the access. [Table 14-4](#) describes the processor response to accesses through the external debug and memory-mapped interfaces.

Table 14-4 External register conditions

Name	Condition	Description
Off	EDPRSR.PU is 0	Processor power domain is completely off, or in a low-power state where the processor power domain registers cannot be accessed.
DLK	EDPRSR.DLK is 1	OS Double Lock is locked.
OSLK	OSLSR_EL1.OSLK is 1	OS Lock is locked.
EDAD	AllowExternalDebugAccess() ==FALSE	External debug access is disabled. When an error is returned because of an EDAD condition code, and this is the highest priority error condition, EDPRSR.SDAD is set to 1. Otherwise EDPRSR.SDAD is unchanged.
SLK	Memory-mapped interface only	Software lock is locked. For the external debug interface, ignore this row.
Default	-	None of the conditions apply, normal access.

[Table 14-5](#) shows an example of external register condition codes for access to a cross trigger register. To determine the access permission for the register, scan the columns from left to right. Stop at the first column a condition is true, the entry gives the access permission of the register and scanning stops.

Table 14-5 External register condition code example

Off	DLK	OSLK	EDAD	SLK	Default
-	-	-	-	RO/WI	RO

14.5 Cross trigger register descriptions

This section describes the Cortex-A53 MPCore Cross Trigger registers. The *Cross trigger register summary* on page 14-5 provides cross-references to the individual registers.

14.5.1 CTI Device Identification Register

The CTIDEVID characteristics are:

- Purpose** Describes the CTI component to the debugger.
- Usage constraints** The accessibility of CTIDEVID by condition code is:

Off	DLK	OSLK	EDAD	SLK	Default
-	-	-	-	RO	RO

Table 14-4 on page 14-7 describes the condition codes.

- Configurations** CTIDEVID is in the Debug power domain.
- Attributes** See the register summary in Table 14-3 on page 14-5.

Figure 14-2 shows the CTIDEVID bit assignments.

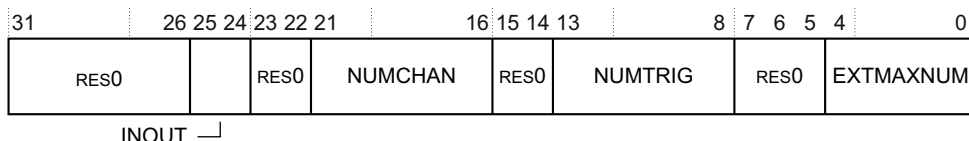

Figure 14-2 CTIDEVID bit assignments

Table 14-6 shows the CTIDEVID bit assignments.

Table 14-6 CTIDEVID bit assignments

Bits	Name	Function
[31:26]	-	Reserved, RES0.
[25:24]	INOUT	Input and output options. Indicates the presence of an input gate. The possible values are: 0b00 CTIGATE does not mask propagation of input events from external channels. 0b01 CTIGATE masks propagation of input events from external channels.
[23:22]	-	Reserved, RES0.
[21:16]	NUMCHAN	Number of channels implemented. This value is: 0b00100 Four channels implemented.
[15:14]	-	Reserved, RES0.
[13:8]	NUMTRIG	Number of triggers implemented. This value is: 0b01000 Eight triggers implemented.
[7:5]	-	Reserved, RES0.
[4:0]	EXTMAXNUM	Maximum number of external triggers implemented. This value is: 0b00000 No external triggers implemented.

CTIDEVID can be accessed through the internal memory-mapped interface and the external debug interface, offset 0xFC8.

14.5.2 CTI Integration Mode Control Register

The CTIITCTRL characteristics are:

Purpose The CTIITCTRL shows that the Cortex-A53 processor does not implement an integration mode.

Usage constraints The accessibility of CTIITCTRL by condition code is:

Off	DLK	OSLK	EDAD	SLK	Default
-	-	-	-	RO/WI	RW

Table 14-4 on page 14-7 describes the condition codes.

Configurations CTIITCTRL is in the Debug power domain.

Attributes See the register summary in Table 14-3 on page 14-5.

Figure 14-3 shows the CTIITCTRL bit assignments.

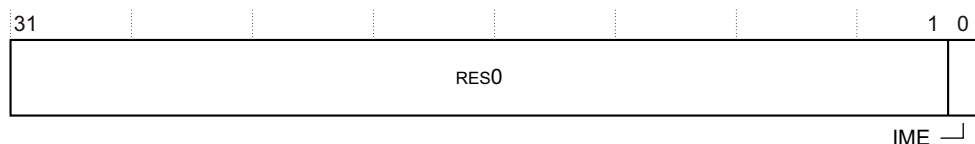

Figure 14-3 CTIITCTRL bit assignments

Table 14-7 shows the CTIITCTRL bit assignments.

Table 14-7 CTIITCTRL bit assignments

Bits	Name	Function
[31:1]	-	Reserved, RES0.
[0]	IME	Integration mode enable. The possible value is: 0 Normal operation.

CTIITCTRL can be accessed through the internal memory-mapped interface and the external debug interface, offset 0xF00.

14.5.3 CTI Peripheral Identification Registers

The Peripheral Identification Registers provide standard information required for all components that conform to the ARM CoreSight architecture. There is a set of eight registers, listed in register number order in [Table 14-8](#).

Table 14-8 Summary of the Peripheral Identification Registers

Register	Value	Offset
Peripheral ID4	0x04	0xFD0
Peripheral ID5	0x00	0xFD4
Peripheral ID6	0x00	0xFD8
Peripheral ID7	0x00	0xFDC
Peripheral ID0	0xA8	0xFE0
Peripheral ID1	0xB9	0xFE4
Peripheral ID2	0x2B	0xFE8
Peripheral ID3	0x00	0xFEC

Only bits[7:0] of each Peripheral ID Register are used, with bits[31:8] reserved. Together, the eight Peripheral ID Registers define a single 64-bit Peripheral ID.

The Peripheral ID registers are:

- [Peripheral Identification Register 0](#).
- [Peripheral Identification Register 1](#) on page 14-11.
- [Peripheral Identification Register 2](#) on page 14-12.
- [Peripheral Identification Register 3](#) on page 14-12.
- [Peripheral Identification Register 4](#) on page 14-13.
- [Peripheral Identification Register 5-7](#) on page 14-14.

Peripheral Identification Register 0

The CTIPIDR0 characteristics are:

Purpose Provides information to identify a CTI component.

Usage constraints The accessibility of CTIPIDR0 by condition code is:

Off	DLK	OSLK	EPMAD	SLK	Default
-	-	-	-	RO	RO

[Table 14-4 on page 14-7](#) describes the condition codes.

Configurations CTIPIDR0 is in the Debug power domain.
CTIPIDR0 is optional to implement in the external register interface.

Attributes See the register summary in [Table 14-3 on page 14-5](#).

[Figure 14-4 on page 14-11](#) shows the CTIPIDR0 bit assignments.

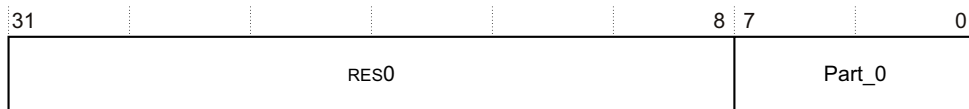

Figure 14-4 CTIPIDR0 bit assignments

Table 14-9 shows the CTIPIDR0 bit assignments.

Table 14-9 CTIPIDR0 bit assignments

Bits	Name	Function
[31:8]	-	Reserved, RES0.
[7:0]	Part_0	0xA8 Least significant byte of the cross trigger part number.

CTIPIDR0 can be accessed through the internal memory-mapped interface and the external debug interface, offset 0xFE0.

Peripheral Identification Register 1

The CTIPIDR1 characteristics are:

Purpose Provides information to identify a CTI component.

Usage constraints The accessibility of CTIPIDR1 by condition code is:

Off	DLK	OSLK	EP MAD	SLK	Default
-	-	-	-	RO	RO

Table 14-4 on page 14-7 describes the condition codes.

Configurations CTIPIDR1 is in the Debug power domain.
CTIPIDR1 is optional to implement in the external register interface.

Attributes See the register summary in Table 14-3 on page 14-5.

Figure 14-5 shows the CTIPIDR1 bit assignments.

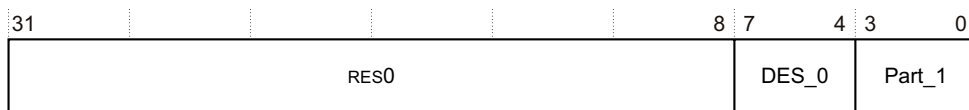

Figure 14-5 CTIPIDR1 bit assignments

Table 14-10 shows the CTIPIDR1 bit assignments.

Table 14-10 CTIPIDR1 bit assignments

Bits	Name	Function
[31:8]	-	Reserved, RES0.
[7:4]	DES_0	0xB ARM Limited. This is the least significant nibble of JEP106 ID code.
[3:0]	Part_1	0x9 Most significant nibble of the CTI part number.

CTIPIDR1 can be accessed through the internal memory-mapped interface and the external debug interface, offset 0xFE4.

Peripheral Identification Register 2

The CTIPIDR2 characteristics are:

Purpose Provides information to identify a CTI component.

Usage constraints The accessibility of CTIPIDR2 by condition code is:

Off	DLK	OSLK	EPMA	SLK	Default
-	-	-	-	RO	RO

Table 14-4 on page 14-7 describes the condition codes.

Configurations CTIPIDR2 is in the Debug power domain.
 CTIPIDR2 is optional to implement in the external register interface.

Attributes See the register summary in Table 14-3 on page 14-5.

Figure 14-6 shows the CTIPIDR2 bit assignments.

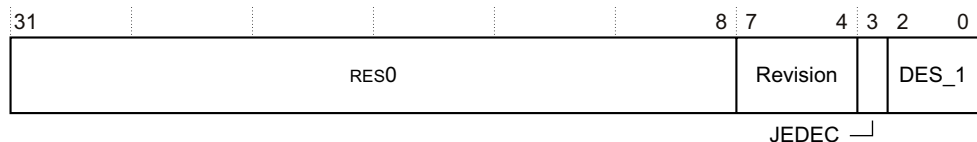

Figure 14-6 CTIPIDR2 bit assignments

Table 14-11 shows the CTIPIDR2 bit assignments.

Table 14-11 CTI PIDR2 bit assignments

Bits	Name	Function
[31:8]	-	Reserved, RES0.
[7:4]	Revision	0x2 r0p2.
[3]	JEDEC	0b1 RES1. Indicates a JEP106 identity code is used.
[2:0]	DES_1	0b011 ARM Limited. This is the most significant nibble of JEP106 ID code.

CTIPIDR2 can be accessed through the internal memory-mapped interface and the external debug interface, offset 0xFE8.

Peripheral Identification Register 3

The CTIPIDR3 characteristics are:

Purpose Provides information to identify a CTI component.

Usage constraints The accessibility of CTIPIDR3 by condition code is:

Off	DLK	OSLK	EPMA	SLK	Default
-	-	-	-	RO	RO

Table 14-4 on page 14-7 describes the condition codes.

Configurations CTIPIDR3 is in the Debug power domain.
CTIPIDR3 is optional to implement in the external register interface.

Attributes See the register summary in Table 14-3 on page 14-5.

Figure 14-7 shows the CTIPIDR3 bit assignments.

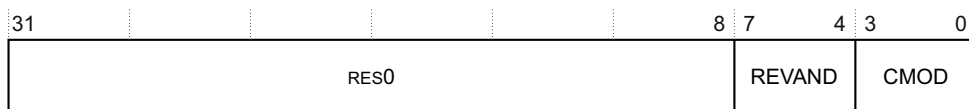

Figure 14-7 CTIPIDR3 bit assignments

Table 14-12 shows the CTIPIDR3 bit assignments.

Table 14-12 CTIPIDR3 bit assignments

Bits	Name	Function
[31:8]	-	Reserved, RES0.
[7:4]	REVAND	0x0 Part minor revision.
[3:0]	CMOD	0x0 Customer modified.

CTIPIDR3 can be accessed through the internal memory-mapped interface and the external debug interface, offset 0xFEC.

Peripheral Identification Register 4

The CTIPIDR4 characteristics are:

Purpose Provides information to identify a CTI component.

Usage constraints The accessibility of CTIPIDR4 by condition code is:

Off	DLK	OSLK	EPMA	SLK	Default
-	-	-	-	RO	RO

Table 14-4 on page 14-7 describes the condition codes.

Configurations CTIPIDR4 is in the Debug power domain.
CTIPIDR4 is optional to implement in the external register interface.

Attributes See the register summary in Table 14-3 on page 14-5.

Figure 14-8 on page 14-14 shows the CTIPIDR4 bit assignments.

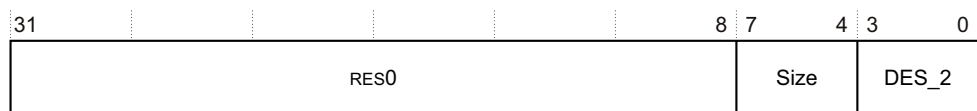

Figure 14-8 CTIPIDR4 bit assignments

Table 14-13 shows the CTIPIDR4 bit assignments.

Table 14-13 CTIPIDR4 bit assignments

Bits	Name	Function
[31:8]	-	Reserved, RES0.
[7:4]	Size	0x0 Size of the component. Log2 the number of 4KB pages from the start of the component to the end of the component ID registers.
[3:0]	DES_2	0x4 ARM Limited. This is the least significant nibble JEP106 continuation code.

CTIPIDR4 can be accessed through the internal memory-mapped interface and the external debug interface, offset 0xFD0.

Peripheral Identification Register 5-7

No information is held in the Peripheral ID5, Peripheral ID6, and Peripheral ID7 Registers. They are reserved for future use and are RES0.

14.5.4 Component Identification Registers

There are four read-only Component Identification Registers, Component ID0 through Component ID3. Table 14-14 shows these registers.

Table 14-14 Summary of the Component Identification Registers

Register	Value	Offset
Component ID0	0x0D	0xFF0
Component ID1	0x90	0xFF4
Component ID2	0x05	0xFF8
Component ID3	0xB1	0xFFC

The Component ID registers are:

- [Component Identification Register 0](#).
- [Component Identification Register 1](#) on page 14-15.
- [Component Identification Register 2](#) on page 14-16.
- [Component Identification Register 3](#) on page 14-17.

Component Identification Register 0

The CTICIDR0 characteristics are:

Purpose Provides information to identify a CTI component.

Usage constraints The accessibility of CTICIDR0 by condition code is:

Off	DLK	OSLK	EPAD	SLK	Default
-	-	-	-	RO	RO

Table 14-4 on page 14-7 describes the condition codes.

Configurations CTICIDR0 is in the Debug power domain.
CTICIDR0 is optional to implement in the external register interface.

Attributes See the register summary in Table 14-3 on page 14-5.

Figure 14-9 shows the CTICIDR0 bit assignments.

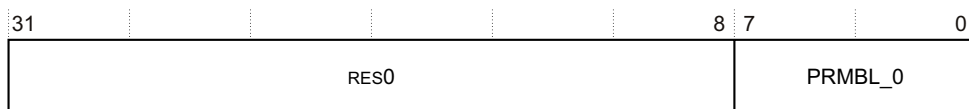

Figure 14-9 CTICIDR0 bit assignments

Table 14-15 shows the CTICIDR0 bit assignments.

Table 14-15 CTICIDR0 bit assignments

Bits	Name	Function
[31:8]	-	Reserved, RES0.
[7:0]	PRMBL_0	0x0D Preamble byte 0.

CTICIDR0 can be accessed through the internal memory-mapped interface and the external debug interface, offset 0xFF0.

Component Identification Register 1

The CTICIDR1 characteristics are:

Purpose Provides information to identify a CTI component.

Usage constraints The accessibility of CTICIDR1 by condition code is:

Off	DLK	OSLK	EPAD	SLK	Default
-	-	-	-	RO	RO

Table 14-4 on page 14-7 describes the condition codes.

Configurations CTICIDR1 is in the Debug power domain.
CTICIDR1 is optional to implement in the external register interface.

Attributes See the register summary in Table 14-3 on page 14-5.

Figure 14-10 on page 14-16 shows the CTICIDR1 bit assignments.

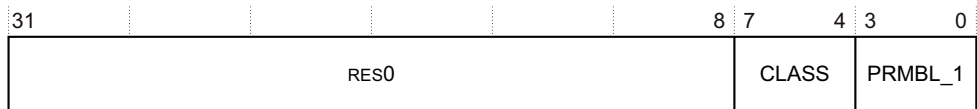

Figure 14-10 CTICIDR1 bit assignments

Table 14-16 shows the CTICIDR1 bit assignments.

Table 14-16 CTICIDR1 bit assignments

Bits	Name	Function
[31:8]	-	Reserved, RES0.
[7:4]	CLASS	0x9 Debug component.
[3:0]	PRMBL_1	0x0 Preamble byte 1.

CTICIDR1 can be accessed through the internal memory-mapped interface and the external debug interface, offset 0xFF4.

Component Identification Register 2

The CTICIDR2 characteristics are:

Purpose Provides information to identify a CTI component.

Usage constraints The accessibility of CTICIDR2 by condition code is:

Off	DLK	OSLK	EPMAD	SLK	Default
-	-	-	-	RO	RO

Table 14-4 on page 14-7 describes the condition codes.

Configurations CTICIDR2 is in the Debug power domain.
CTICIDR2 is optional to implement in the external register interface.

Attributes See the register summary in Table 14-3 on page 14-5.

Figure 14-11 shows the CTICIDR2 bit assignments.

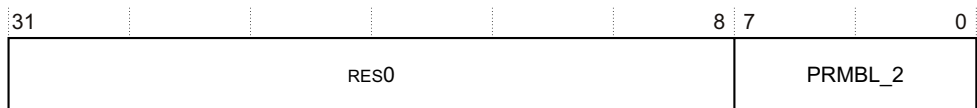

Figure 14-11 CTICIDR2 bit assignments

Table 14-17 shows the CTICIDR2 bit assignments.

Table 14-17 CTICIDR2 bit assignments

Bits	Name	Function
[31:8]	-	Reserved, RES0.
[7:0]	PRMBL_2	0x05 Preamble byte 2.

CTICIDR2 can be accessed through the internal memory-mapped interface and the external debug interface, offset 0xFF8.

Component Identification Register 3

The CTICIDR3 characteristics are:

Purpose Provides information to identify a CTI component.

Usage constraints The accessibility of CTICIDR3 by condition code is:

Off	DLK	OSLK	EPMA	SLK	Default
-	-	-	-	RO	RO

Table 14-4 on page 14-7 describes the condition codes.

Configurations CTICIDR3 is in the Debug power domain.
 CTICIDR3 is optional to implement in the external register interface.

Attributes See the register summary in Table 14-3 on page 14-5.

Figure 14-12 shows the CTICIDR3 bit assignments.

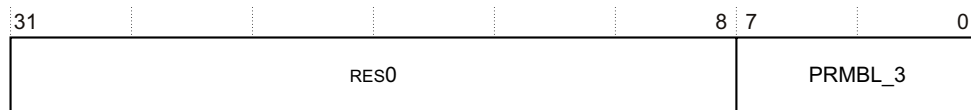

Figure 14-12 CTICIDR3 bit assignments

Table 14-18 shows the CTICIDR3 bit assignments.

Table 14-18 CTICIDR3 bit assignments

Bits	Name	Function
[31:8]	-	Reserved, RES0.
[7:0]	PRMBL_3	0xB1 Preamble byte 3.

CTICIDR3 can be accessed through the internal memory-mapped interface and the external debug interface, offset 0xFFC.

Appendix A

Signal Descriptions

This appendix describes the Cortex-A53 processor signals. It contains the following sections:

- *About the signal descriptions on page A-2.*
- *Clock signals on page A-3.*
- *Reset signals on page A-4.*
- *Configuration signals on page A-5.*
- *Generic Interrupt Controller signals on page A-6.*
- *Generic Timer signals on page A-8.*
- *Power management signals on page A-9.*
- *L2 error signals on page A-11.*
- *ACE and CHI interface signals on page A-12.*
- *CHI interface signals on page A-13.*
- *ACE interface signals on page A-17.*
- *ACP interface signals on page A-22.*
- *External debug interface on page A-25.*
- *ATB interface signals on page A-28.*
- *Miscellaneous ETM trace unit signals on page A-29.*
- *CTI interface signals on page A-30.*
- *PMU interface signals on page A-31.*
- *DFT and MBIST interface signals on page A-32.*

A.1 About the signal descriptions

The tables in this appendix list the Cortex-A53 processor signals, along with their direction, input or output, and a high-level description.

Some of the buses include a configurable width field, <Signal>[CN:0], where CN = 0, 1, 2, or 3, to encode up to four cores. For example:

- **nIRQ[0]** represents a core 0 interrupt request.
- **nIRQ[2]** represents a core 2 interrupt request.

Some signals are specified in the form <signal>x where x = 0, 1, 2 or 3 to reference core 0, core 1, core 2, core 3. If a core is not present, the corresponding pin is removed. For example:

- **PMUEVENT0[29:0]** represents the core 0 PMU event bus.
- **PMUEVENT3[29:0]** represents the core 3 PMU event bus.

The number of signals changes depending on the configuration. For example, the AMBA 5 CHI interface signals are not present when the processor is configured to have an AMBA 4 ACE interface.

A.2 Clock signals

Table A-1 shows the clock signal.

Table A-1 Clock signal

Signal	Direction	Description
CLKIN	Input	Global clock

A.3 Reset signals

Table A-2 shows the reset and reset control signals.

Table A-2 Reset and reset control signals

Signal	Direction	Description
nCPUPORESET[CN:0]	Input	Processor powerup reset:
		0 Apply reset to all processor logic ^a .
		1 Do not apply reset to all processor logic ^a .
nCORERESET[CN:0]	Input	Individual core resets excluding Debug and ETM trace unit:
		0 Apply reset to processor logic ^b .
		1 Do not apply reset to processor logic ^b .
nL2RESET	Input	L2 memory system reset:
		0 Apply reset to shared L2 memory system controller.
		1 Do not apply reset to shared L2 memory system controller.
L2RSTDISABLE	Input	Disable automatic L2 cache invalidate at reset:
		0 Hardware resets L2 cache.
		1 Hardware does not reset L2 cache.
WARMRSTREQ[CN:0]	Output	Processor warm reset request
		0 Apply warm reset.
		1 Do not apply warm reset.

a. Processor logic includes Advanced SIMD and Floating-point, Debug, ETM trace unit, breakpoint and watchpoint logic.

b. Processor logic includes Advanced SIMD and Floating-point, but excludes Debug, ETM trace unit, breakpoint and watchpoint logic.

———— **Note** ————

- See **nPRESETDBG** in Table A-34 on page A-25.
- See **nMBISTRESET** in Table A-41 on page A-32.

A.4 Configuration signals

Table A-3 shows the configuration signals.

Table A-3 Configuration signals

Signal	Direction	Description
AA64nAA32[CN:0]	Input	Register width state: 0 AArch32. 1 AArch64. This pin is sampled only during reset of the processor.
CFGEND[CN:0]	Input	Endianness configuration at reset. It sets the initial value of the EE bits in the CP15 SCTLR_EL3 and SCTR_S registers: 0 EE bit is LOW. 1 EE bit is HIGH. This pin is sampled only during reset of the processor.
CFGTE[CN:0]	Input	Enable T32 exceptions. It sets the initial value of the TE bit in the CP15 SCTLR register: 0 TE bit is LOW. 1 TE bit is HIGH. This pin is sampled only during reset of the processor.
CLUSTERIDAFF1[7:0]	Input	Value read in the Cluster ID Affinity Level 1 field, MPIDR bits [15:8], of the CP15 MPDIR register. These pins are sampled only during reset of the processor.
CLUSTERIDAFF2[7:0]	Input	Value read in the Cluster ID Affinity Level 2 field, MPIDR bits [23:16], of the CP15 MPDIR register. These pins are sampled only during reset of the processor.
CP15SDISABLE[CN:0]	Input	Disable write access to some secure CP15 registers.
CRYPTODISABLE[CN:0]	Input	Disables the Cryptography Extensions. This pin is sampled only during reset of the processor.
RVBARADDRx[39:2]	Input	Reset Vector Base Address for executing in 64-bit state. These pins are sampled only during reset of the processor.
VINITHI[CN:0]	Input	Location of the exception vectors at reset. It sets the initial value of the V bit in the CP15 SCTLR register: 0 Exception vectors start at address 0x00000000. 1 Exception vectors start at address 0xFFFF0000. This pin is sampled only during reset of the processor.

A.5 Generic Interrupt Controller signals

Table A-4 shows the *Generic Interrupt Controller* (GIC) signals.

Table A-4 GIC signals

Signal	Direction	Description
nFIQ[CN:0]	Input	<p>FIQ request. Active-LOW, level sensitive, asynchronous FIQ interrupt request:</p> <p>0 Activate FIQ interrupt.</p> <p>1 Do not activate FIQ interrupt.</p> <p>The processor treats the nFIQ input as level-sensitive. The nFIQ input must be asserted until the processor acknowledges the interrupt.</p>
nIRQ[CN:0]	Input	<p>IRQ request input lines. Active-LOW, level sensitive, asynchronous interrupt request:</p> <p>0 Activate interrupt.</p> <p>1 Do not activate interrupt.</p> <p>The processor treats the nIRQ input as level-sensitive. The nIRQ input must be asserted until the processor acknowledges the interrupt.</p>
nSEI[CN:0]	Input	<p>System Error Interrupt request. Active-LOW, edge sensitive:</p> <p>0 Activate SEI request.</p> <p>1 Do not activate SEI request.</p>
nVFIQ[CN:0]	Input	<p>Virtual FIQ request. Active-LOW, level sensitive, asynchronous FIQ interrupt request:</p> <p>0 Activate FIQ interrupt.</p> <p>1 Do not activate FIQ interrupt.</p> <p>The processor treats the nVFIQ input as level-sensitive. The nVFIQ input must be asserted until the processor acknowledges the interrupt. If the GIC is enabled by tying the GICCDISABLE input pin LOW, the nVFIQ input pin must be tied off to HIGH. If the GIC is disabled by tying the GICCDISABLE input pin HIGH, the nVFIQ input pin can be driven by an external GIC in the SoC.</p>
nVIRQ[CN:0]	Input	<p>Virtual IRQ request. Active-LOW, level sensitive, asynchronous interrupt request:</p> <p>0 Activate interrupt.</p> <p>1 Do not activate interrupt.</p> <p>The processor treats the nVIRQ input as level-sensitive. The nVIRQ input must be asserted until the processor acknowledges the interrupt. If the GIC is enabled by tying the GICCDISABLE input pin LOW, the nVIRQ input pin must be tied off to HIGH. If the GIC is disabled by tying the GICCDISABLE input pin HIGH, the nVIRQ input pin can be driven by an external GIC in the SoC.</p>
nVSEI[CN:0]	Input	<p>Virtual System Error Interrupt request. Active-LOW, edge sensitive:</p> <p>0 Activate virtual SEI request.</p> <p>1 Do not activate virtual SEI request.</p>
nREI[CN:0]	Input	<p>RAM Error Interrupt request. Active-LOW, edge sensitive:</p> <p>0 Activate REI request. Reports an asynchronous RAM error in the system.</p> <p>1 Do not activate REI request.</p>
nVCPUMNTIRQ[CN:0]	Output	Virtual CPU interface maintenance interrupt PPI output.
PERIPHBASE[39:18]	Input	Specifies the base address for the GIC registers. This value is sampled into the CP15 <i>Configuration Base Address Register</i> (CBAR) at reset.

Table A-4 GIC signals (continued)

Signal	Direction	Description
GICCDISABLE	Input	Globally disables the CPU interface logic and routes the “External” signals directly to the processor: 0 Enable the GIC CPU interface logic. 1 Disable the GIC CPU interface logic. Required to enable use of non-ARM interrupt controllers.
ICDTVALID	Input	AXI4 Stream Protocol signal. Distributor to GIC CPU Interface messages. TVALID indicates that the master is driving a valid transfer.
ICDTREADY	Output	AXI4 Stream Protocol signal. Distributor to GIC CPU Interface messages. TREADY indicates that the slave can accept a transfer in the current cycle.
ICDTDATA[15:0]	Input	AXI4 Stream Protocol signal. Distributor to GIC CPU Interface messages. TDATA is the primary payload that is used to provide the data that is passing across the interface.
ICDTLAST	Input	AXI4 Stream Protocol signal. Distributor to GIC CPU Interface messages. TLAST indicates the boundary of a packet.
ICDTDEST[1:0]	Input	AXI4 Stream Protocol signal. Distributor to GIC CPU Interface messages. TDEST provides routing information for the data stream.
ICCTVALID	Output	AXI4 Stream Protocol signal. GIC CPU Interface to Distributor messages. TVALID indicates that the master is driving a valid transfer.
ICCTREADY	Input	AXI4 Stream Protocol signal. GIC CPU Interface to Distributor messages. TREADY indicates that the slave can accept a transfer in the current cycle.
ICCTDATA[15:0]	Output	AXI4 Stream Protocol signal. GIC CPU Interface to Distributor messages. TDATA is the primary payload that is used to provide the data that is passing across the interface
ICCTLAST	Output	AXI4 Stream Protocol signal. GIC CPU Interface to Distributor messages. TLAST indicates the boundary of a packet.
ICCTID[1:0]	Output	AXI4 Stream Protocol signal. GIC CPU Interface to Distributor. TID is the data stream identifier that indicates different streams of data.

A.6 Generic Timer signals

Table A-5 shows the Generic Timer signals.

Table A-5 Generic Timer signals

Signal	Direction	Description
nCNTHPIRQ[CN:0]	Output	Hypervisor physical timer event.
nCNTPNSIRQ[CN:0]	Output	Non-secure physical timer event.
nCNTPSIRQ[CN:0]	Output	Secure physical timer event.
nCNTVIRQ[CN:0]	Output	Virtual physical timer event.
CNTCLKEN	Input	Counter clock enable. This clock enable must be inserted one cycle before the CNTVALUEB bus.
CNTVALUEB[63:0]	Input	Global system counter value in binary format.

A.7 Power management signals

Table A-6 shows the non-Retention power management signals.

Table A-6 Non-Retention power management signals

Signal	Direction	Description
CLREXMONREQ	Input	Clearing of the external global exclusive monitor request. When this signal is asserted, it acts as a WFE wake-up event to all the cores in the MPCore device. See <i>CLREXMON request and acknowledge signaling on page 2-20</i> for more information.
CLREXMONACK	Output	Clearing of the external global exclusive monitor acknowledge. See <i>CLREXMON request and acknowledge signaling on page 2-20</i> for more information.
EVENTI	Input	Event input for processor wake-up from WFE state. See <i>Event communication using WFE or SEV on page 2-25</i> for more information.
EVENTO	Output	Event output. Active when a SEV instruction is executed. See <i>Event communication using WFE or SEV on page 2-25</i> for more information.
STANDBYWFI[CN:0]	Output	Indicates whether a core is in WFI low-power state: 0 Core not in WFI low-power state. 1 Core in WFI low-power state. This is the reset condition.
STANDBYWFE[CN:0]	Output	Indicates whether a core is in WFE low-power state: 0 Core not in WFE low-power state. 1 Core in WFE low-power state.
STANDBYWFIL2	Output	Indicates whether the L2 memory system is in WFI low-power state. This signal is active when the following conditions are met: <ul style="list-style-type: none"> All cores are in WFI low-power state, held in reset, or nL2RESET is asserted LOW. In an ACE configuration, ACINACTM is asserted HIGH. In a CHI configuration, SINACT is asserted HIGH. If ACP has been configured, AINACTS is asserted HIGH. L2 memory system is idle.
L2FLUSHREQ	Input	L2 hardware flush request.
L2FLUSHDONE	Output	L2 hardware flush complete.
SMPEN[CN:0]	Output	Indicates whether a core is taking part in coherency.
DBGNOPWRDWN[CN:0]	Output	Processor no powerdown request 0 Do not request that the processor stays powered up. 1 Request that the processor stays powered up.
DBGPWRUPREQ[CN:0]	Output	Processor powerup request 0 Do not request processor to power up. 1 Request that the processor is not powered up.
DBGPWRDUP[CN:0]	Input	Processor powered up 0 Processor is powered down. 1 Processor is powered up.

Table A-7 on page A-10 shows the Retention power management signals.

Table A-7 Retention power management signals

Signal	Direction	Description
CPUQACTIVE[CN:0]	Output	Indicates whether the referenced processor is active
CPUQREQn[CN:0]	Input	Indicates that the power controller is ready to enter or exit retention for the referenced processor
CPUQDENY[CN:0]	Output	Indicates that the referenced processor denies the power controller retention request
CPUQACCEPTn[CN:0]	Output	Indicates that the referenced processor accepts the power controller retention request
NEONQACTIVE[CN:0]	Output	Indicates whether the referenced Advanced SIMD and Floating-point block is active
NEONQREQn[CN:0]	Input	Indicates that the power controller is ready to enter or exit retention for the referenced Advanced SIMD and Floating-point block
NEONQDENY[CN:0]	Output	Indicates that the referenced Advanced SIMD and Floating-point block denies the power controller retention request
NEONQACCEPTn[CN:0]	Output	Indicates that the referenced Advanced SIMD and Floating-point block accepts the power controller retention request
L2QACTIVE	Output	Indicates whether the L2 data RAMs are active
L2QREQn	Input	Indicates that the power controller is ready to enter or exit retention for the L2 data RAMs
L2QDENY	Output	Indicates that the L2 data RAMs deny the power controller retention request
L2QACCEPTn	Output	Indicates that the L2 data RAMs accept the power controller retention request

A.8 L2 error signals

Table A-8 shows the L2 error signals.

Table A-8 L2 error signals

Signal	Direction	Description
nEXTERRIRQ	Output	Error indicator for AXI or CHI transactions with a write response error condition. See <i>External aborts handling on page 7-18</i> for more information.
nINTERRIRQ	Output	Error indicator for L2 RAM double-bit ECC error.

A.9 ACE and CHI interface signals

Table A-9 shows the interface signals that both ACE and CHI use.

Table A-9 ACE and CHI interface signals

Signal	Direction	Description
BROADCASTCACHEMAINT^a	Input	Enable broadcasting of cache maintenance operations to downstream caches: 0 Cache maintenance operations are not broadcast to downstream caches. 1 Cache maintenance operations are broadcast to downstream caches. This pin is sampled only during reset of the Cortex-A53 processor.
BROADCASTINNER^a	Input	Enable broadcasting of Inner Shareable transactions: 0 Inner Shareable transactions are not broadcast externally. 1 Inner Shareable transactions are broadcast externally. If BROADCASTINNER is tied HIGH, you must also tie BROADCASTOUTER HIGH. This pin is sampled only during reset of the Cortex-A53 processor.
BROADCASTOUTER^a	Input	Enable broadcasting of outer shareable transactions: 0 Outer Shareable transactions are not broadcast externally. 1 Outer Shareable transactions are broadcast externally. This pin is sampled only during reset of the Cortex-A53 processor.

a. See Table 7-1 on page 7-3 for more information.

A.10 CHI interface signals

This section describes the CHI interface signals:

- *Clock and configuration signals.*
- *Transmit request virtual channel signals.*
- *Transmit response virtual channel signals on page A-14.*
- *Transmit data virtual channel signals on page A-14.*
- *Receive snoop virtual channel signals on page A-14.*
- *Receive response virtual channel signals on page A-14.*
- *Receive data virtual channel signals on page A-15.*
- *System address map signals on page A-15.*

Note

This interface exists only if the Cortex-A53 processor is configured to have the CHI interface.

A.10.1 Clock and configuration signals

Table A-10 shows the clock and configuration signals.

Table A-10 Clock and configuration signals

Signal	Direction	Description
SCLKEN	Input	CHI interface bus clock enable
SINACT	Input	CHI snoop active
NODEID[6:0]	Input	Cortex-A53 CHI Node Identifier
RXSACTIVE	Input	Receive pending activity indicator
TXSACTIVE	Output	Transmit pending activity indicator
RXLINKACTIVEREQ	Input	Receive link active request
RXLINKACTIVEACK	Output	Receive link active acknowledge
TXLINKACTIVEREQ	Output	Transmit link active request
TXLINKACTIVEACK	Input	Transmit link active acknowledge
REQMEMATTR[7:0]	Output	Request memory attributes

A.10.2 Transmit request virtual channel signals

Table A-11 shows the transmit request virtual channel signals.

Table A-11 Transmit request virtual channel signals

Signal	Direction	Description
TXREQFLITPEND	Output	Transmit request flit pending
TXREQFLITV	Output	Transmit request flit valid
TXREQFLIT[99:0]	Output	Transmit request flit payload
TXREQLCRDV	Input	Transmit request link-layer credit valid

A.10.3 Transmit response virtual channel signals

Table A-12 shows the transmit response virtual channel signals.

Table A-12 Transmit response virtual channel signals

Signal	Direction	Description
TXRSPFLITPEND	Output	Transmit response flit pending
TXRSPFLITV	Output	Transmit response flit valid
TXRSPFLIT[44:0]	Output	Transmit response flit
TXRSPLCRDV	Input	Transmit response link-layer credit valid

A.10.4 Transmit data virtual channel signals

Table A-13 shows the transmit data virtual channel signals.

Table A-13 Transmit data virtual channel signals

Signal	Direction	Description
TXDATFLITPEND	Output	Transmit data flit pending
TXDATFLITV	Output	Transmit data flit valid
TXDATFLIT[193:0]	Output	Transmit data flit
TXDATLCRDV	Input	Transmit data link-layer credit valid

A.10.5 Receive snoop virtual channel signals

Table A-14 shows the receive snoop virtual channel signals.

Table A-14 Receive snoop virtual channel signals

Signal	Direction	Description
RXSNPFLITPEND	Input	Receive snoop flit pending
RXSNPFLITV	Input	Receive snoop flit valid
RXSNPFLIT[64:0]	Input	Receive snoop flit
RXSNPLCRDV	Output	Receive snoop link-layer credit valid

A.10.6 Receive response virtual channel signals

Table A-15 shows the receive response virtual channel signals.

Table A-15 Receive response virtual channel signals

Signal	Direction	Description
RXRSPFLITPEND	Input	Receive response flit pending

Table A-15 Receive response virtual channel signals (continued)

Signal	Direction	Description
RXRSPFLITV	Input	Receive response flit valid
RXRSPFLIT[44:0]	Input	Receive response flit
RXRSPLCRDV	Output	Receive response link-layer credit valid

A.10.7 Receive data virtual channel signals

Table A-16 shows the receive data virtual channel signals.

Table A-16 Receive Data virtual channel signals

Signal	Direction	Description
RXDATFLITPEND	Input	Receive data flit pending
RXDATFLITV	Input	Receive data flit valid
RXDATFLIT[193:0]	Input	Receive data flit
RXDATLCRDV	Output	Receive data link-layer credit valid

A.10.8 System address map signals

Table A-17 shows the system address map signals.

Table A-17 System address map signals

Signal	Direction	Description
SAMADDRMAP0[1:0]	Input	Region mapping, 0 – 512MB
SAMADDRMAP1[1:0]	Input	Region mapping, 512MB – 1GB
SAMADDRMAP2[1:0]	Input	Region mapping, 1GB – 1.5GB
SAMADDRMAP3[1:0]	Input	Region mapping, 1.5GB – 2GB
SAMADDRMAP4[1:0]	Input	Region mapping, 2GB – 2.5GB
SAMADDRMAP5[1:0]	Input	Region mapping, 2.5GB – 3GB
SAMADDRMAP6[1:0]	Input	Region mapping, 3GB – 3.5GB
SAMADDRMAP7[1:0]	Input	Region mapping, 3.5GB – 4GB
SAMADDRMAP8[1:0]	Input	Region mapping, 4GB – 8GB
SAMADDRMAP9[1:0]	Input	Region mapping, 8GB – 16GB
SAMADDRMAP10[1:0]	Input	Region mapping, 16GB – 32GB
SAMADDRMAP11[1:0]	Input	Region mapping, 32GB – 64GB
SAMADDRMAP12[1:0]	Input	Region mapping, 64GB – 128GB
SAMADDRMAP13[1:0]	Input	Region mapping, 128GB – 256GB
SAMADDRMAP14[1:0]	Input	Region mapping, 256GB – 512GB

Table A-17 System address map signals (continued)

Signal	Direction	Description
SAMADDRMAP15[1:0]	Input	Region mapping, 512GB – 1TB
SAMMNBASE[39:24]	Input	MN base address ^a
SAMMNODEID[6:0]	Input	MN node ID
SAMHNI0NODEID[6:0]	Input	HN-I 0 node ID
SAMHNI1NODEID[6:0]	Input	HN-I 1 node ID
SAMHNF0NODEID[6:0]	Input	HN-F 0 node ID
SAMHNF1NODEID[6:0]	Input	HN-F 1 node ID
SAMHNF2NODEID[6:0]	Input	HN-F 2 node ID
SAMHNF3NODEID[6:0]	Input	HN-F 3 node ID
SAMHNF4NODEID[6:0]	Input	HN-F 4 node ID
SAMHNF5NODEID[6:0]	Input	HN-F 5 node ID
SAMHNF6NODEID[6:0]	Input	HN-F 6 node ID
SAMHNF7NODEID[6:0]	Input	HN-F 7 node ID
SAMHNFMODE[2:0]	Input	HN-F interleaving module

- a. **SAMMNBASE** must reside in a **SAMADDRMAPx[1:0]** that corresponds to the HN-I.

A.11 ACE interface signals

This section describes the ACE master interface signals:

- [Clock and configuration signals](#).
- [Write address channel signals on page A-18](#).
- [Write data channel signals on page A-18](#).
- [Write data response channel signals on page A-19](#).
- [Read address channel signals on page A-19](#).
- [Read data channel signals on page A-20](#).
- [Coherency address channel signals on page A-20](#).
- [Coherency response channel signals on page A-20](#).
- [Coherency data channel handshake signals on page A-21](#).
- [Read and write acknowledge signals on page A-21](#).

For a complete description of the ACE interface signals, see the *ARM® AMBA® AXI and ACE Protocol Specification AXI3, AXI4, and AXI4-Lite, ACE and ACE-Lite*.

Note

- This interface exists only if the Cortex-A53 processor is configured to have the ACE interface.
- All ACE channels must be balanced with respect to **CLKIN** and timed relative to **ACLKENM**.

A.11.1 Clock and configuration signals

[Table A-18](#) shows the clock and configuration signals for the ACE interface.

Table A-18 Clock and configuration signals

Signal	Direction	Description
ACLKENM	Input	ACE Master bus clock enable. See Clocks on page 2-9 for more information.
ACINACTM	Input	Snoop interface is inactive and not participating in coherency: 0 Snoop interface is active. 1 Snoop interface is inactive.
SYSBARDISABLE	Input	Disable broadcasting of barriers onto the system bus: 0 Barriers are broadcast onto the system bus. This requires an AMBA4 ACE, or AMBA5 CHI, interconnect. 1 Barriers are not broadcast onto the system bus. This is compatible with an AXI3 interconnect and most AMBA4 interconnects. ^a This pin is sampled only during reset of the Cortex-A53 processor.
RDMEMATTR[7:0]	Output	Read request memory attributes.
WRMEMATTR[7:0]	Output	Write request memory attributes.

a. See [Barriers on page 7-11](#).

A.11.2 Write address channel signals

Table A-19 shows the write address channel signals for the ACE interface.

Table A-19 Write address channel signals

Signal	Direction	Description
AWADDRM[43:0]	Output	Write address.
AWBARM[1:0]	Output	Write barrier type.
AWBURSTM[1:0]	Output	Write burst type.
AWCACHEDM[3:0]	Output	Write cache type.
AWDOMAINM[1:0]	Output	Write shareability domain type.
AWIDM[4:0]	Output	Write address ID.
AWLENM[7:0]	Output	Write burst length.
AWLOCKM	Output	Write lock type.
AWPROTM[2:0]	Output	Write protection type.
AWREADYM	Input	Write address ready.
AWSIZEM[2:0]	Output	Write burst size.
AWSNOOPM[2:0]	Output	Write snoop request type.
AWUNIQUEM	Output	For WriteBack, WriteClean and WriteEvict transactions. Indicates that the write is: 0 Shared. 1 Unique.
AWVALIDM	Output	Write address valid.

A.11.3 Write data channel signals

Table A-20 shows the write data channel signals for the ACE interface.

Table A-20 Write data channel signals

Signal	Direction	Description
WDATAM[127:0]	Output	Write data
WIDM[4:0]	Output	Write data ID
WLASTM	Output	Write data last transfer indication
WREADYM	Input	Write data ready
WSTRBM[15:0]	Output	Write byte-lane strobes
WVALIDM	Output	Write data valid

A.11.4 Write data response channel signals

Table A-21 shows the write data response channel signals for the ACE master interface.

Table A-21 Write data response channel signals

Signal	Direction	Description
BIDM[4:0]	Input	Write response ID
BREADYM	Output	Write response ready
BRESPM[1:0]	Input	Write response
BVALIDM	Input	Write response valid

A.11.5 Read address channel signals

Table A-22 shows the read address channel signals for the ACE master interface.

Table A-22 Read address channel signals

Signal	Direction	Description
ARADDRM[43:0]	Output	Read address. The top 4 bits communicate only the ACE virtual address for DVM messages. The top 4 bits are Read-as-Zero if a DVM message is not being broadcast.
ARBARM[1:0]	Output	Read barrier type.
ARBURSTM[1:0]	Output	Read burst type.
ARCACHEM[3:0]	Output	Read cache type.
ARDOMAINM[1:0]	Output	Read shareability domain type.
ARIDM[5:0]	Output	Read address ID.
ARLENM[7:0]	Output	Read burst length.
ARLOCKM	Output	Read lock type.
ARPROTM[2:0]	Output	Read protection type.
ARREADYM	Input	Read address ready.
ARSIZEM[2:0]	Output	Read burst size.
ARNOOPM[3:0]	Output	Read snoop request type.
ARVALIDM	Output	Read address valid.

A.11.6 Read data channel signals

Table A-23 shows the read data channel signals for the ACE master interface.

Table A-23 Read data channel signals

Signal	Direction	Description
RDATAM[127:0]	Input	Read data
RIDM[5:0]	Input	Read data ID
RLASTM	Input	Read data last transfer indication
RREADYM	Output	Read data ready
RRESPM[3:0]	Input	Read data response
RVALIDM	Input	Read data valid

A.11.7 Coherency address channel signals

Table A-24 shows the coherency address channel signals for the ACE master interface.

Table A-24 Coherency address channel signals

Signal	Direction	Description
ACADDRM[43:0]	Input	Snoop address. The top 4 bits communicate only the ACE virtual address for DVM messages.
ACPROTM[2:0]	Input	Snoop protection type.
ACREADYM	Output	Master ready to accept snoop address.
ACSNOOPM[3:0]	Input	Snoop request type.
ACVALIDM	Input	Snoop address valid.

A.11.8 Coherency response channel signals

Table A-25 shows the coherency response channel signals for the ACE master interface.

Table A-25 Coherency response channel signals

Signal	Direction	Description
CRREADYM	Input	Slave ready to accept snoop response
CRVALIDM	Output	Snoop response
CRRESPM[4:0]	Output	Snoop response valid

A.11.9 Coherency data channel handshake signals

Table A-26 shows the coherency data channel handshake signals for the ACE master interface.

Table A-26 Coherency data channel handshake signals

Signal	Direction	Description
CDDATAM[127:0]	Output	Snoop data
CDLASTM	Output	Snoop data last transform
CDREADYM	Input	Slave ready to accept snoop data
CDVALIDM	Output	Snoop data valid

A.11.10 Read and write acknowledge signals

Table A-27 shows the read/write acknowledge signals for the ACE master interface.

Table A-27 Read and write acknowledge signals

Signal	Direction	Description
RACKM	Output	Read acknowledge
WACKM	Output	Write acknowledge

A.12 ACP interface signals

This section describes the ACP interface signals:

- *Clock and configuration signals.*
- *Write address channel signals.*
- *Write data channel signals on page A-23.*
- *Write response channel signals on page A-23.*
- *Read address channel signals on page A-23.*
- *Read data channel signals on page A-24.*

Note

- This interface exists only if the Cortex-A53 processor is configured to have the ACP interface.
 - All ACP channels must be balanced with respect to **CLKIN** and timed relative to **ACLKENS**.
-

A.12.1 Clock and configuration signals

Table A-28 shows the clock and configuration signals for the ACP interface.

Table A-28 Clock and Configuration signals

Signal	Direction	Description
ACLKENS	Input	AXI slave bus clock enable.
AINACTS	Input	ACP master is inactive and is not participating in coherency. There must be no outstanding transactions when the master asserts this signal, and while it is asserted the master must not send any new transactions: 0 ACP Master is active. 1 ACP Master is inactive.
<hr/> Note <hr/> This signal must be asserted before the processor enters the low power L2 WFI state. <hr/>		

A.12.2 Write address channel signals

Table A-29 shows the write address channel signals for the ACP interface.

Table A-29 Write address channel signals

Signal	Direction	Description
AWREADYS	Output	Write address ready
AWVALIDS	Input	Write address valid
AWIDS[4:0]	Input	Write address ID
AWADDRS[39:0]	Input	Write address
AWLENS[7:0]	Input	Write burst length

Table A-29 Write address channel signals (continued)

Signal	Direction	Description
AWCACHES[3:0]	Input	Write cache type
AWUSERS[1:0]	Input	Write attributes: [0] Inner Shareable. [1] Outer Shareable.
AWPROTS[2:0]	Input	Write protection type

A.12.3 Write data channel signals

Table A-30 shows the write data channel signals for the ACP interface.

Table A-30 Write data channel signals

Signal	Direction	Description
WREADYS	Output	Write data ready
WVALIDS	Input	Write data valid
WDATAS[127:0]	Input	Write data
WSTRBS[15:0]	Input	Write byte-lane strobes
WLASTS	Input	Write data last transfer indication

A.12.4 Write response channel signals

Table A-31 shows the write response channel signals for the ACP interface.

Table A-31 Write response channel signals

Signal	Direction	Description
BREADYS	Input	Write response ready
BVALIDS	Output	Write response valid
BIDS[4:0]	Output	Write response ID
BRESPS[1:0]	Output	Write response

A.12.5 Read address channel signals

Table A-32 shows the read address channel signals for the ACP interface.

Table A-32 Read address channel signals

Signal	Direction	Description
ARREADYS	Output	Read address ready
ARVALIDS	Input	Read address valid
ARIDS[4:0]	Input	Read address ID
ARADDRS[39:0]	Input	Read address

Table A-32 Read address channel signals (continued)

Signal	Direction	Description
ARLENS[7:0]	Input	Read burst length
ARCACHES[3:0]	Input	Read cache type
ARUSERS[1:0]	Input	Read attributes: [0] Inner Shareable. [1] Outer Shareable.
ARPROTS[2:0]	Input	Read protection type

A.12.6 Read data channel signals

Table A-33 shows the read data channel signals for the ACP interface.

Table A-33 Read data channel signals

Signal	Direction	Description
RREADYS	Input	Read data ready
RVALIDS	Output	Read data valid
RIDS[4:0]	Output	Read data ID
RDATAS[127:0]	Output	Read data
RRESPS[1:0]	Output	Read response
RLASTS	Output	Read data last transfer indication

A.13 External debug interface

The following sections describe the external debug interface signals:

- [APB interface signals](#).
- [Miscellaneous debug signals](#).

A.13.1 APB interface signals

[Table A-34](#) shows the APB interface signals.

———— **Note** —————

You must balance all APB interface signals with respect to **CLKIN** and time them relative to **PCLKENDBG**.

Table A-34 APB interface signals

Signal	Direction	Description
nPRESETDBG	Input	APB reset, active-LOW: 0 Apply reset to APB interface. 1 Do not apply reset to APB interface.
PADDRDBG[21:2]	Input	APB address bus.
PADDRDBG31	Input	APB address bus bit[31]: 0 Not an external debugger access. 1 External debugger access.
PCLKENDBG	Input	APB clock enable.
PENABLEDBG	Input	Indicates the second and subsequent cycles of an APB transfer.
PRDATADBG[31:0]	Output	APB read data.
PREADYDBG	Output	APB slave ready. An APB slave can deassert PREADYDBG to extend a transfer by inserting wait states.
PSELDBG	Input	Debug bus access.
PSLVERRDBG	Output	APB slave transfer error: 0 No transfer error. 1 Transfer error.
PWDATADBG[31:0]	Input	APB write data.
PWRITEDBG	Input	APB read or write signal: 0 Reads from APB. 1 Writes to APB.

A.13.2 Miscellaneous debug signals

[Table A-35 on page A-26](#) shows the miscellaneous Debug signals.

Table A-35 Miscellaneous Debug signals

Signal	Direction	Description
DBGROMADDR[39:12]	Input	Debug ROM base address. Specifies bits[39:12] of the ROM table physical address. If the address cannot be determined, tie this signal LOW. This pin is sampled only during reset of the processor.
DBGROMADDRV	Input	Debug ROM base address valid. If the debug ROM address cannot be determined, tie this signal LOW. This pin is sampled only during reset of the processor.
DBGACK[CN:0]	Output	Debug acknowledge: 0 External debug request not acknowledged. 1 External debug request acknowledged.
nCOMMIRQ[CN:0]	Output	Communications channel receive or transmit interrupt request 0 Request interrupt. 1 No interrupt request.
COMMRX[CN:0]	Output	Communications channel receive. Receive portion of Data Transfer Register full flag: 0 Empty. 1 Full.
COMMTX[CN:0]	Output	Communication transmit channel. Transmit portion of Data Transfer Register empty flag: 0 Full. 1 Empty.
EDBGRQ[CN:0]	Input	External debug request: 0 No external debug request. 1 External debug request. The processor treats the EDBGRQ input as level-sensitive. The EDBGRQ input must be asserted until the processor asserts DBGACK .
DBGEN[CN:0]	Input	Invasive debug enable: 0 Not enabled. 1 Enabled.
NIDEN[CN:0]	Input	Non-invasive debug enable: 0 Not enabled. 1 Enabled.
SPIDEN[CN:0]	Input	Secure privileged invasive debug enable: 0 Not enabled. 1 Enabled.
SPNIDEN[CN:0]	Input	Secure privileged non-invasive debug enable: 0 Not enabled. 1 Enabled.
DBGRSTREQ[CN:0]	Output	Warm reset request.
DBGNOPWRDWN[CN:0]	Output	No powerdown request: 0 On a powerdown request, the SoC power controller powers down the processor. 1 On a powerdown request, the SoC power controller does not power down the processor.

Table A-35 Miscellaneous Debug signals (continued)

Signal	Direction	Description
DBGPWRDUP[CN:0]	Input	Processor powered up.
DBGPWRUPREQ[CN:0]	Output	Power up request: 0 Power down debug request to the power controller. 1 Power up request to the power controller.
DBGL1RSTDISABLE	Input	Disable L1 data cache automatic invalidate on reset functionality: 0 Enable automatic invalidation of L1 data cache on reset. 1 Disable automatic invalidation of L1 data cache on reset. This pin is sampled only during reset of the processor.

A.14 ATB interface signals

Table A-36 shows the ATB interface signals.

———— **Note** —————

- You must balance all ATB interface signals with respect to **CLKIN** and time them relative to **ATCLKEN**.

Table A-36 ATB interface signals

Signal	Direction	Description
ATCLKEN	Input	ATB clock enable
ATREADYMx	Input	ATB device ready
AFVALIDMx	Input	FIFO flush request
ATDATAMx[31:0]	Output	Data
ATVALIDMx	Output	Data valid
ATBYTESMx[1:0]	Output	Data size
AFREADYMx	Output	FIFO flush finished
ATIDMx[6:0]	Output	Trace source ID

A.15 Miscellaneous ETM trace unit signals

Table A-37 shows the miscellaneous ETM trace unit signals.

Table A-37 Miscellaneous ETM trace unit signals

Signal	Direction	Description
SYNCREQMx	Input	Synchronization request from trace sink
TSVALUEB[63:0]	Input	Timestamp in binary encoding

A.16 CTI interface signals

Table A-38 shows the CTI interface signals.

Table A-38 CTI interface signals

Signal	Direction	Description
CTICHIN[3:0]	Input	Channel In
CTICHOUTACK[3:0]	Input	Channel Out acknowledge
CTICHOUT[3:0]	Output	Channel Out
CTICHINACK[3:0]	Output	Channel In acknowledge
CISBYPASS	Input	Channel interface sync bypass
CIHSBYPASS[3:0]	Input	Channel interface H/S bypass
CTHRQ[CN:0]	Output	CTI interrupt (active-HIGH)
CTHRQACK[CN:0]	Input	CTI interrupt acknowledge

A.17 PMU interface signals

Table A-39 shows the PMU interface signals.

Table A-39 PMU interface signals

Signal	Direction	Description
PMUEVENTx[29:0]	Output	PMU event bus
nPMUIRQ[CN:0]	Output	PMU interrupt request

A.18 DFT and MBIST interface signals

This section describes:

- *DFT interface.*
- *MBIST interface.*

A.18.1 DFT interface

Table A-40 shows the DFT interface signals.

Table A-40 DFT interface signals

Signal	Direction	Description
DFTRAMHOLD	Input	Disable the RAM chip select during scan testing
DFTRSTDISABLE	Input	Disable internal synchronized reset during scan shift
DFTSE	Input	Scan shift enable, forces on the clock grids during scan shift
DFTMCPHOLD	Input	Disable Multicycle Paths on RAM interfaces

A.18.2 MBIST interface

Table A-41 shows the MBIST interface signals.

———— **Note** —————

A Cortex-A53 processor does not include an external MBIST address and data interface port. The MBIST address and data interface ports are internally tied-off in the design, and you can insert MBIST into the design before synthesis. The process of adding MBIST into the design can be done automatically by an EDA MBIST tool.

Table A-41 MBIST interface signals

Signal	Direction	Description
MBISTREQ	Input	MBIST test request
nMBISTRESET	Input	MBIST reset

Appendix B

Cortex-A53 Processor AArch32 UNPREDICTABLE Behaviors

This appendix describes specific Cortex-A53 processor UNPREDICTABLE behaviors of particular interest.

For AArch32 execution, the ARMv8-A architecture specifies a much narrower range of legal behaviors for the cases that in ARMv7 were described as UNPREDICTABLE. See *ARM® Architecture Reference Manual ARMv8, for ARMv8-A architecture profile*. This gives considerable background on this topic and documents these UNPREDICTABLE behaviors in these sections:

- A range of legal behaviors for each UNPREDICTABLE case.
- A single preferred behavior for each UNPREDICTABLE case from that range of legal behaviors.

Where possible and practical, all ARM implementations adhere to these single preferred behaviors. In some limited instances an ARM implementation might not adhere to these single preferred behaviors, and instead behaves as described by one of the alternate legal behaviors.

The purpose of this appendix is to document all such instances where the Cortex-A53 processor implementation diverges from the preferred behavior described in *ARMv8 AArch32 UNPREDICTABLE behaviors*, and to describe exactly which of the remaining alternative behaviors is implemented.

This appendix contains the following sections:

- [Use of R15 by Instruction on page B-3.](#)
- [unpredictable instructions within an IT Block on page B-4.](#)

- *Load/Store accesses crossing page boundaries* on page B-5.
- *ARMv8 Debug unpredictable behaviors* on page B-6.
- *Other unpredictable behaviors* on page B-11.

B.1 Use of R15 by Instruction

Specification

All uses of R15 as a named register specifier for a source register that is described as UNPREDICTABLE in the *ARM® Architecture Reference Manual ARMv8, for ARMv8-A architecture profile* pseudo-code, or in other places in the *ARM® Architecture Reference Manual ARMv8, for ARMv8-A architecture profile*, read 0 unless otherwise stated in section 4.28, or as described in the following paragraph.

If the use of R15 as a base register for a load or store is UNPREDICTABLE, the value used by the load or store using R15 as a base register is the *Program Counter* (PC) with its usual offset and, in the case of T32 instructions, with the forced word alignment. In this case, if the instruction specifies Writeback, then the load or store is performed without Writeback.

Implementation

The Cortex-A53 processor does not implement a *Read 0* policy on UNPREDICTABLE use of R15 by instruction. Instead, the Cortex-A53 processor takes an UNDEFINED exception trap.

B.2 UNPREDICTABLE instructions within an IT Block

Specification

Conditional instructions within an IT Block, described as being UNPREDICTABLE in the *ARM® Architecture Reference Manual ARMv8, for ARMv8-A architecture profile* pseudo-code, are executed unconditionally.

Implementation

The Cortex-A53 processor does not implement an unconditional execution policy for the following instructions. Instead all execute conditionally:

- NEON instructions new to ARMv8.
- All instructions in the ARMv8 Cryptographic Extensions.
- CRC32.

B.3 Load/Store accesses crossing page boundaries

This section describes load or store accesses that cross page boundaries. It contains the following sections:

- [Crossing a page boundary with different memory types or shareability attributes.](#)
- [Crossing a 4KB boundary with a Device \(or Strongly-Ordered\) accesses.](#)

B.3.1 Crossing a page boundary with different memory types or shareability attributes

Specification

In section A3.5.7 of the *ARM® Architecture Reference Manual ARMv8, for ARMv8-A architecture profile*, having memory accesses from one load or store instruction cross a page boundary with different memory types or shareability, is UNPREDICTABLE. In this situation, the implementation:

- Uses the memory type and shareability attributes associated with its own address for each memory access from this instruction.

B.3.2 Crossing a 4KB boundary with a Device (or Strongly-Ordered) accesses

Specification

In section A3.5.7 of the *ARM® Architecture Reference Manual ARMv8, for ARMv8-A architecture profile*, having memory accesses from one load or store instruction to Device, or Strongly-ordered, memory cross a 4 KB boundary, is UNPREDICTABLE. In this situation, the implementation:

- Performs all memory accesses from this instruction as if the presence of the boundary had no effect on the memory accesses.

Implementation (for both page boundary specifications)

All ARMv8 memory types can be divided into Device memory or Normal memory. Device memory contains four different supported memory types:

- Device-nGnRnE
- Device-nGnRE
- Device-nGRE
- Device-GRE.

These replace the ARMv7 Strongly-ordered and Device memory types.

Normal memory contains NC, WB, WT cacheability attributes. For a split line, an access that crosses any page boundary, the following items enumerate all possible Cortex-A53 processor behaviors:

- Store crossing a page boundary:
 - No fault, always split into two stores that then behave according to the attributes of the page that each store hits.
- Load crossing a page boundary:
 - Device->Device and Normal->Normal. No fault, load is split into two accesses. Each access behaves according to the attributes of the page that each load hits.
 - Device->Normal and Normal->Device. Results in an alignment fault.

B.4 ARMv8 Debug UNPREDICTABLE behaviors

The *ARMv8 Debug Implementation Envelope* architectural reference document describes UNPREDICTABLE behaviors associated with Debug. Some topics list behavior *Options* and many include a *Preference* behavior. For any particular topics that have multiple options, the information in this section describes which option the Cortex-A53 processor implements. Additionally, for any particular topics for which the Cortex-A53 processor behavior diverges from either or both of the *Options* and *Preferences*, an explanation of the actual behavior is given. If there is only a single Option for a specific topic in *ARMv8 Debug Implementation Envelope*, if the Cortex-A53 processor follows the recommended behavior, then there are no more explanatory comments in this appendix for that topic or behavior.

B.4.1 A32 BKPT instruction with condition code not AL

The Cortex-A53 processor implements the preferred option:

- Option 3: executed unconditionally.

B.4.2 Address match breakpoint match only on second halfword of an instruction

The Cortex-A53 processor generates a breakpoint on the instruction, unless it is a breakpoint on the second half of the first 32-bit instruction. In this case the breakpoint is taken on the following instruction.

B.4.3 Address matching breakpoint on A32 instruction with DBGBCRn.BAS=1100

The Cortex-A53 processor implements:

- Option 1: Does match.

B.4.4 Address match breakpoint match on T32 instruction at DBGBCRn+2 with DBGBCRn.BAS=1111

The Cortex-A53 processor implements:

- Option 1: Does match.

B.4.5 Address mismatch breakpoint match on T32 instruction at DBGBCRn +2 with DBGBCRn.BAS=1111

The Cortex-A53 processor implements:

- Option 1: Does match.

B.4.6 Other mismatch breakpoint matches any address in current mode and state

The Cortex-A53 processor implements:

- Option 2: Immediate breakpoint debug event.

B.4.7 Mismatch breakpoint on branch to self

The Cortex-A53 processor implements:

- Option 2: Instruction is stepped an UNKNOWN number of times, while it continues to branch to itself.

B.4.8 Link to nonexistent breakpoint or breakpoint that is not context-aware

The Cortex-A53 processor implements:

- Option 1: No Breakpoint or Watchpoint debug event is generated, and the LBN field of the *linker* reads UNKNOWN.

B.4.9 DBGWCRn_EL1.MASK!=0000 and DBGWCRn_EL1.BAS!=11111111

The Cortex-A53 processor behaves as indicated in the sole Preference:

- DBGWCRn_EL1.BAS is ignored and treated as if 0b11111111

B.4.10 Address-matching Vector catch on 32-bit T32 instruction at (vector-2)

The Cortex-A53 processor implements:

- Option 1: Does match.

B.4.11 Address-matching Vector catch on 32-bit T32 instruction at (vector+2)

The Cortex-A53 processor implements:

- Option 1: Does match.

B.4.12 Address-matching Vector catch and Breakpoint on same instruction

The Cortex-A53 processor implements:

- Option 2: Report Breakpoint.

B.4.13 Address match breakpoint with DBGBCRn_EL1.BAS=0000

The Cortex-A53 processor implements:

- Option 1. As if disabled.

B.4.14 DBGWCRn_EL1.BAS specifies a non-contiguous set of bytes within a double-word

The Cortex-A53 processor implements:

- A Watchpoint debug event is generated for each byte.

B.4.15 A32 HLT instruction with condition code not AL

The Cortex-A53 processor implements:

- Option 3. Executed unconditionally.

B.4.16 Execute instruction at a given EL when the corresponding EDECCR bit is 1 and Halting is allowed

The Cortex-A53 processor behaves as follows:

- Generates debug event and Halt no later than the instruction following the next Context Synchronization operation (CSO) excluding ISB instruction.

B.4.17 Unlinked Context matching and Address mismatch breakpoints taken to Abort mode

The Cortex-A53 processor implements:

- Option 2: A Prefetch Abort debug exception is generated. Because the breakpoint is configured to generate a breakpoint at PL1, the instruction at the Prefetch Abort vector generates a Vector catch debug event.

———— **Note** ————

The debug event is subject to the same CONSTRAINED UNPREDICTABLE behavior, therefore the Breakpoint debug event is repeatedly generated an UNKNOWN number of times.

B.4.18 Vector catch on Data or Prefetch abort, and taken to Abort mode

The Cortex-A53 processor implements:

- Option 2: A Prefetch Abort debug exception is generated. If Vector catch is enabled on the Prefetch Abort vector, this generates a Vector catch debug event.

———— **Note** ————

The debug event is subject to the same CONSTRAINED UNPREDICTABLE behavior, and so the Vector catch debug event is repeatedly generated an UNKNOWN number of times.

B.4.19 $H > N$ or $H = 0$ at Non-secure EL1 and EL0, including value read from PMCR_EL0.N

The Cortex-A53 processor implements:

- A simple implementation where all of HPMN[4:0] are implemented, and In Non-secure EL1 and EL0:
 - If $H > N$ then $M = N$
 - If $H = 0$ then $M = 0$.

B.4.20 $H > N$ or $H = 0$: value read back in MDCR_EL2.HPMN

The Cortex-A53 processor implements:

- A simple implementation where all of HPMN[4:0] are implemented and:
 - For reads of MDCR_EL2.HPMN, to return H.

B.4.21 $P \geq M$ and $P \neq 31$: reads and writes of PMXEVTYPER_EL0 and PMXEVCNTR_EL0

The Cortex-A53 processor implements:

- A simple implementation where all of SEL[4:0] are implemented, and if $P \geq M$ and $P \neq 31$ then the register is RES0.

B.4.22 $P \geq M$ and $P \neq 31$: value read in PMSELR_EL0.SEL

The Cortex-A53 processor implements:

- A simple implementation where all of SEL[4:0] are implemented, and if $P \geq M$ and $P \neq 31$ then the register is RES0.

B.4.23 P = 31: reads and writes of PMXVCNTR_EL0

The Cortex-A53 processor implements:

- RES0

B.4.24 $n \geq M$: Direct access to PMEVCNTRn_EL0 and PMEVTYPERn_EL0

The Cortex-A53 processor implements:

- If $n \geq N$, then the instruction is UNALLOCATED.
- Otherwise if $n \geq M$, then the register is RES0.

B.4.25 Exiting Debug state while instruction issued through EDITR is in flight

The Cortex-A53 processor implements:

- Option 1: The instruction completes in Debug state before executing the restart.

B.4.26 Using memory-access mode with a non-word-aligned address

The Cortex-A53 processor behaves as indicated in the sole Preference:

- Does unaligned accesses, faulting if these are not permitted for the memory type.

B.4.27 Access to memory-mapped registers mapped to Normal memory

The Cortex-A53 processor behaves as indicated in the sole Preference:

- The access is generated, and accesses might be repeated, gathered, split or resized, in accordance with the rules for Normal memory, meaning the effect is UNPREDICTABLE.

B.4.28 Not word-sized accesses or (AArch64 only) doubleword-sized accesses

The Cortex-A53 processor behaves as indicated in the sole Preference:

- Reads occur and return UNKNOWN data
- Writes set the accessed register(s) to UNKNOWN.

B.4.29 External debug write to register that is being reset

The Cortex-A53 processor behaves as indicated in the sole Preference:

- Takes reset value

B.4.30 Accessing reserved debug registers

The Cortex-A53 processor deviates from Preferred behavior because the hardware cost to decode some of these addresses in debug power domain is significantly high:

Actual behavior:

1. For reserved debug and Performance Monitors registers the response is CONSTRAINED UNPREDICTABLE Error or RES0, when any of the following error instead of preferred RES0 for reserved debug registers `0x000-0xCFC` and reserved PMU registers `0x000-0xF00`:
 - Off** Core power domain is either completely off, or in a low-power state where the Core power domain registers cannot be accessed.
 - DLK** `DoubleLockStatus()` is TRUE, OS double-lock is locked, that is, `EDPRSR.DLK` is 1).
 - OSLK** `OSLSR_EL1.OSLK` is 1, OS lock is locked.

2. In addition, for reserved debug registers in the address ranges 0x400 to 0x4FC and 0x800 to 0x8FC, the response is CONSTRAINED UNPREDICTABLE Error or RES0 when the conditions in 1 do not apply and:

EDAD AllowExternalDebugAccess() is FALSE, external debug access is disabled.

3. For reserved Performance Monitor registers in the address ranges 0x000 to 0x0FC and 0x400 to 0x47C, the response is CONSTRAINED UNPREDICTABLE Error, or RES0 when the conditions in 1 and 2 do not apply, and the following errors instead of preferred res0 for the these registers:

EPMAD AllowExternalPMUAccess() is FALSE (external Performance Monitors access is disabled).

B.4.31 Clearing the *clear-after-read* EDPRSR bits when Core power domain is on, and DoubleLockStatus() is TRUE

The Cortex-A53 processor behaves as indicated in the sole Preference:

- Bits are not cleared to zero.

B.5 Other UNPREDICTABLE behaviors

This section describes other UNPREDICTABLE behaviors:

- *CSSELR indicates a cache that is not implemented*
- *HDCR.HPMN is set to 0, or to a value larger than PMCR.N*

B.5.1 CSSELR indicates a cache that is not implemented

If CSSELR indicates a cache that is not implemented, then on a read of the CCSIDR the behavior is CONSTRAINED UNPREDICTABLE, and can be one of the following:

- The CCSIDR read is treated as NOP.
- The CCSIDR read is UNDEFINED.
- The CCSIDR read returns an UNKNOWN value (preferred).

B.5.2 HDCR.HPMN is set to 0, or to a value larger than PMCR.N

If HDCR.HPMN is set to 0, or to a value larger than PMCR.N, then the behavior in Non-secure EL0 and EL1 is CONSTRAINED UNPREDICTABLE, and one of the following must happen:

- The number of counters accessible is an UNKNOWN non-zero value less than PMCR.N.
- There is no access to any counters.

For reads of HDCR.HPMN by EL2 or higher, if this field is set to 0 or to a value larger than PMCR.N, the processor must return a CONSTRAINED UNPREDICTABLE value that is one of:

- PMCR.N.
- The value that was written to HDCR.HPMN.
- (The value that was written to HDCR.HPMN) modulo 2^h , where h is the smallest number of bits required for a value in the range 0 to PMCR.N.

Appendix C

Revisions

This appendix describes the technical changes between released issues of this book.

Table C-1 Issue A

Change	Location	Affects
First release	-	-

Table C-2 Differences between Issue A and Issue B

Change	Location	Affects
Cluster device shutdown sequence updated	<i>Cluster shutdown mode without system driven L2 flush on page 2-22</i>	All revisions
Revision information updated.	<i>Chapter 4 System Control</i> <i>GIC programmers model on page 9-3</i> <i>ETM register descriptions on page 13-13</i> <i>Peripheral Identification Register 2 on page 11-29</i> <i>Peripheral Identification Register 2 on page 12-29</i> <i>Peripheral Identification Register 2 on page 14-12</i> <i>Peripheral Identification Register 2 on page 11-47</i>	r0p1
ID_AA64MMFR0_EL1 description updated	<i>AArch64 Memory Model Feature Register 0, EL1 on page 4-41</i>	All revisions

Table C-2 Differences between Issue A and Issue B (continued)

Change	Location	Affects
ACTLR_EL3 description updated.	<i>Auxiliary Control Register, EL3</i> on page 4-56	All revisions
CPUECTLR_EL1 description updated.	<i>CPU Extended Control Register, EL1</i> on page 4-128	All revisions
ACTLR description updated.	<i>Auxiliary Control Register</i> on page 4-196	All revisions
Updated Encodings for ACE master interface	Table 7-6 on page 7-7	All revisions
	Table 7-7 on page 7-8	
List of ACE transactions updated.	<i>ACE transfers</i> on page 7-8	All revisions
Shareability description updated	<i>ACP user signals</i> on page 7-20	All revisions
	Table A-29 on page A-22	
	Table A-32 on page A-23	
GIC signal descriptions updated	<i>Generic Interrupt Controller signals</i> on page A-6	All revisions
CPUECTLR bit assignment table updated	Table 4-245 on page 4-273	All revisions

Table C-3 Differences between Issue B and Issue C

Change	Location	Affects
Change Multiprocessor, Processor to Cluster, Core naming convention	Throughout document	All revisions
Removed reference to T32EE (ThumbEE)	<i>ARM architecture</i> on page 1-3	All revisions
Updated notes in descriptions of PCLKENDBG , ATCLKEN and CNTCLKEN signals	<i>Clocks</i> on page 2-9	All revisions
Updated list of supported core power states	<i>Supported core power states</i> on page 2-18	All revisions
Revision information updated.	Chapter 4 <i>System Control</i>	r0p2
	<i>GIC programmers model</i> on page 9-3	
	<i>ETM register descriptions</i> on page 13-13	
	<i>Peripheral Identification Register 2</i> on page 11-29	
	<i>Peripheral Identification Register 2</i> on page 12-29	
	<i>Peripheral Identification Register 2</i> on page 14-12	
Updated some register summary information	<i>AArch64 register summary</i> on page 4-3	All revisions
	<i>AArch32 register summary</i> on page 4-135	
Updated TTBR1 register description	<i>Translation Table Base Register 1</i> on page 4-226 <i>Translation Table Base Register 1</i> on page 4-226	All revisions
Updated CPUMERRSR_EL1 and CPUMERRSR descriptions	Table 4-118 on page 4-131 Table 4-147 on page 4-156 Table 4-246 on page 4-275	All revisions
Removed DACR from list of c4 registers	<i>c4 registers</i> on page 4-139	All revisions

Table C-3 Differences between Issue B and Issue C (continued)

Change	Location	Affects
Updated GIC system registers in AArch32 summary tables	<i>AArch32 GIC system registers on page 4-154</i> <i>c4 registers on page 4-139</i> <i>c12 registers on page 4-142</i>	All revisions
Added a new table, AArch64 registers used to access internal memory	Table 6-4 on page 6-13	All revisions
Updated Return stack predictions	<i>Return stack predictions on page 6-7</i>	All revisions
Update list of AArch64 registers used to access internal memory	Table 6-4 on page 6-13	All revisions
Added a new table, MOESI states	Table 6-8 on page 6-15	All revisions
Updated ACE transfer information	<i>ACE transfers on page 7-8</i>	All revisions
Updated ACE and CHI master interface write issuing capability	Table 7-5 on page 7-6 Table 7-11 on page 7-13	All revisions
Updated AXI privilege information	<i>AXI privilege information on page 7-12</i>	All revisions
Register names changed in the ROM table Peripheral Identification Registers summary	<i>Summary of the ROM table Peripheral Identification Registers on page 11-45</i>	All revisions
Updated PMU register summary table	Table 12-9 on page 12-14	All revisions
Peripheral identification and Component identification register names changed in Memory-mapped PMU register summary	Table 12-15 on page 12-23	All revisions
Updated ETM exception level information	Table 13-1 on page 13-3	All revisions
Updated ETM programming diagram	Figure 13-2 on page 13-8	All revisions
Updated ETM register purpose and constraint information	Throughout <i>ETM register descriptions on page 13-13</i>	All revisions
Updated ETM register descriptions	Table 13-37 on page 13-42 Table 13-46 on page 13-51	All revisions
Updated TRCITIATBOUTr bit assignments	<i>Integration Instruction ATB Out Register on page 13-59</i>	All revisions
TRCITIATBOUTr.BYTES description updated	Table 13-55 on page 13-59	All revisions
TRCDEVAFF0 description updated to match MPIDR	<i>Device Affinity Register 0 on page 13-62</i>	All revisions
Updated sequence of operations in section 11.10.4 (Changing the authentication signals)	<i>Changing the authentication signals on page 11-40</i>	All revisions

Table C-4 Differences between Issue C and Issue D

Change	Location	Affects
Updated descriptions of Memory Attribute Indirection Registers	<i>Memory Attribute Indirection Register, EL1</i> on page 4-116 <i>Memory Attribute Indirection Register, EL2</i> on page 4-118 <i>Memory Attribute Indirection Register, EL3</i> on page 4-118 <i>Memory Attribute Indirection Registers 0 and 1</i> on page 4-259	All revisions
Instruction mnemonic updated	<i>64-bit registers</i> on page 4-147	All revisions
Added note to CPUECTLR.SMPEN bit description	Table 4-245 on page 4-273	All revisions
SELx signal reduced from 6 bits to 5 bits	Figure 13-21 on page 13-30 Table 13-22 on page 13-30	All revisions
Updated number of external inputs to trace unit	Table 13-39 on page 13-44	All revisions
Footnote added to SAMMNBASE[39,24] description	Table A-17 on page A-15	All revisions