

Thread Models Recap

With some slides modified from
Raymond Namyst, U. Bordeaux

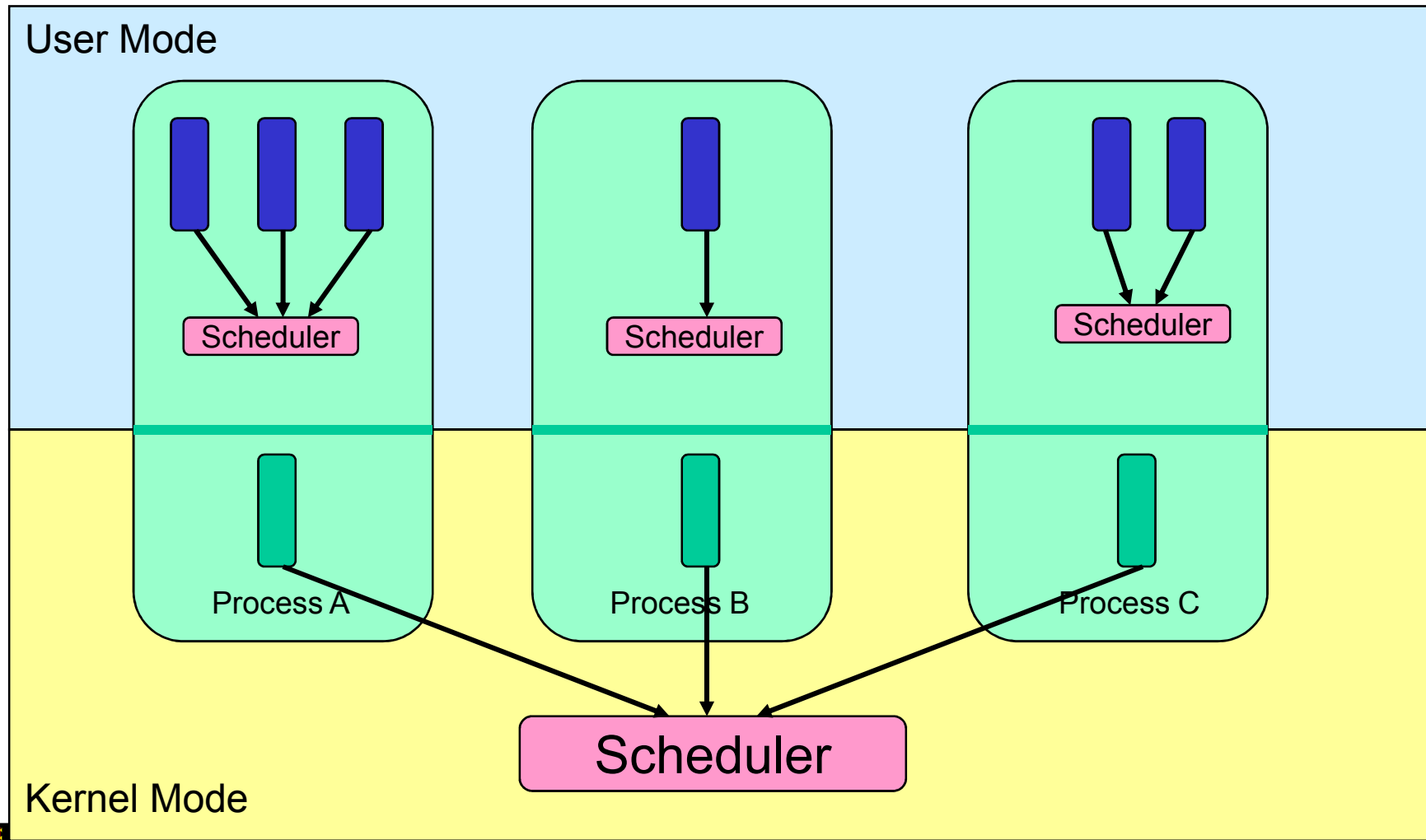

User-level Threads



User-level Threads

- ✓ Fast thread management (creation, deletion, switching, synchronisation...)
- ✗ Blocking blocks all threads in a process
 - Syscalls
 - Page faults
- ✗ No thread-level parallelism on multiprocessor



Kernel-Level Threads

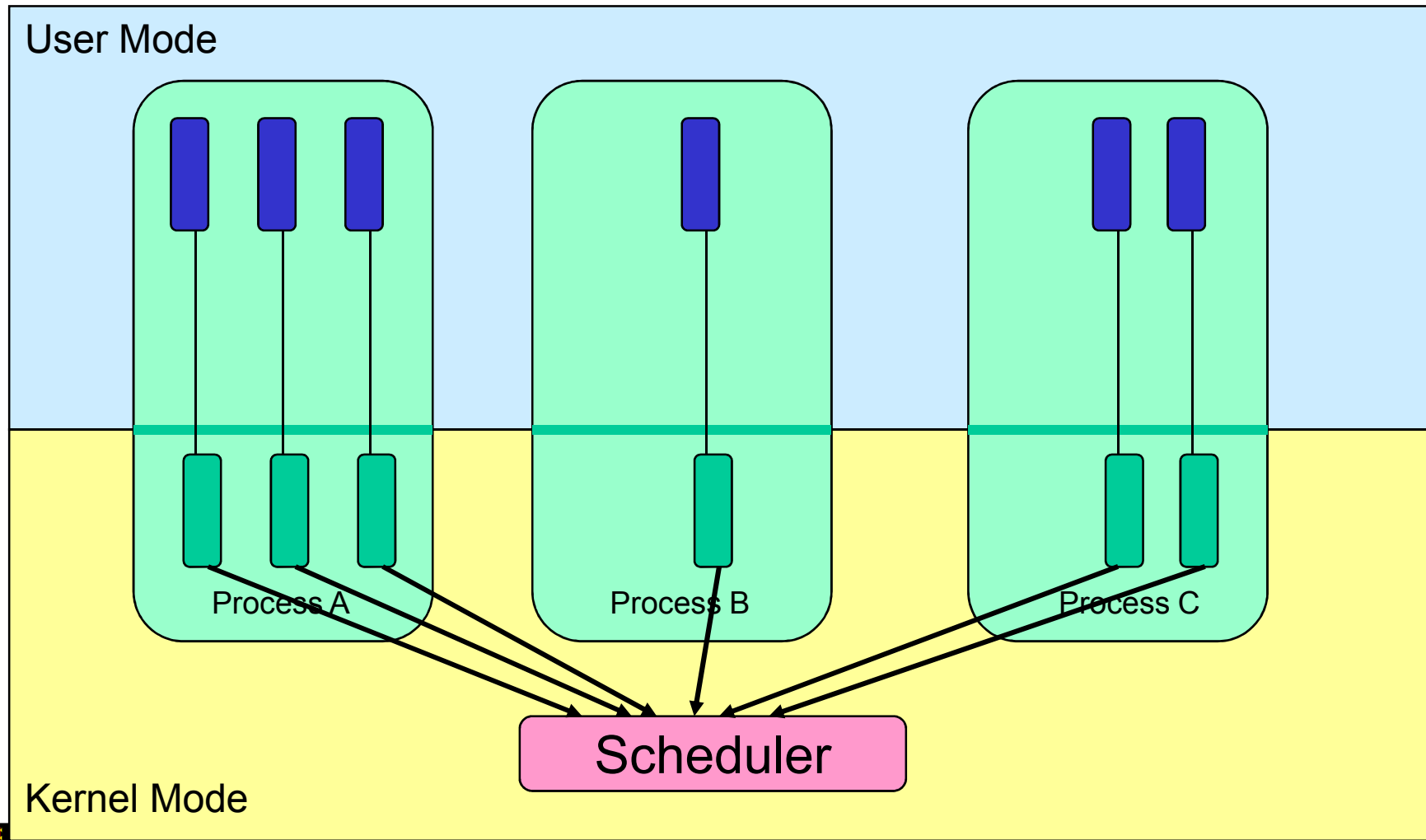

Kernel-level Threads

- ✗ Slow thread management (creation, deletion, switching, synchronisation...)
 - System calls
- ✓ Blocking blocks only the appropriate thread in a process
- ✓ Thread-level parallelism on multiprocessor



Hybrid Multithreading

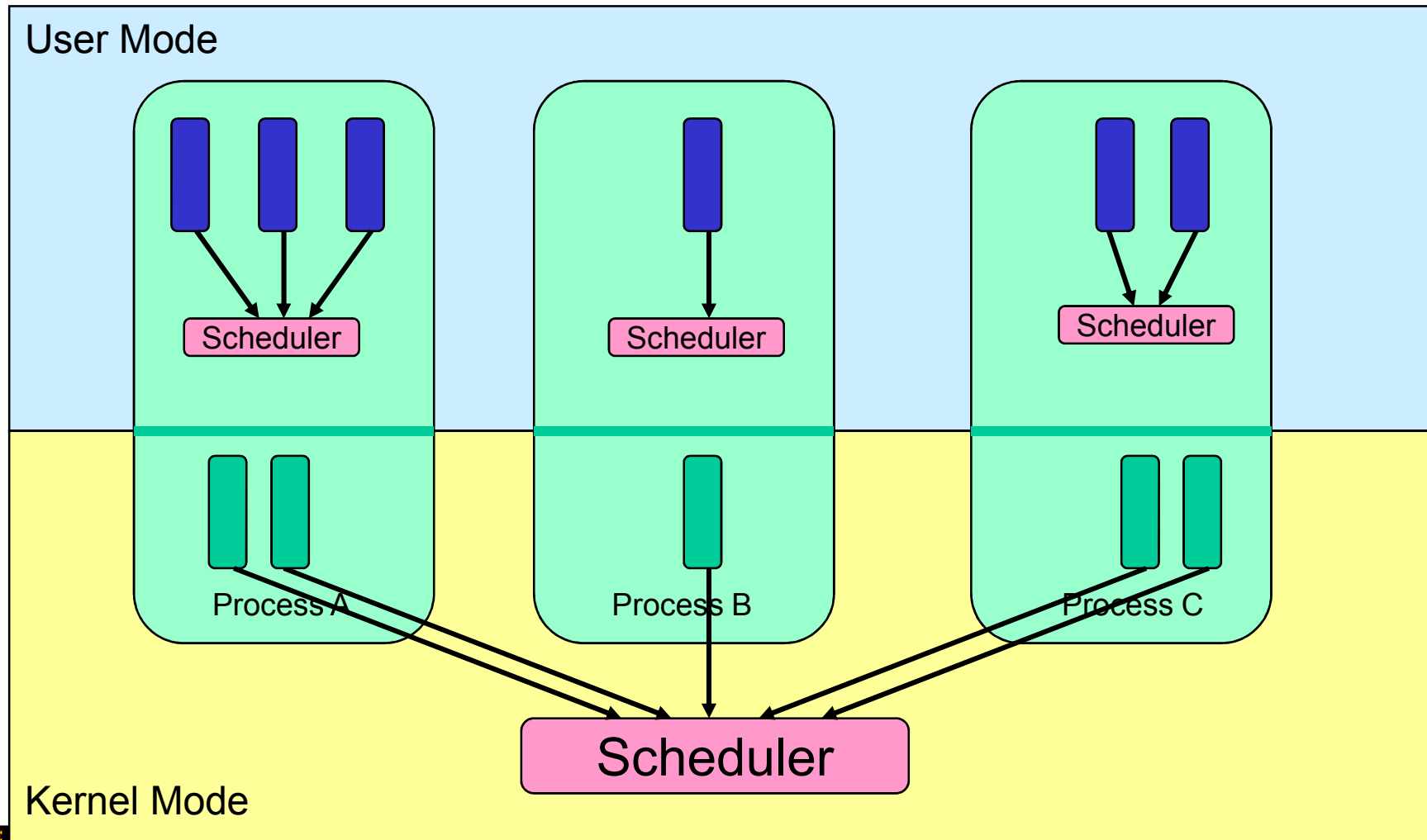

Hybrid Multithreading

- ✓ Can get real thread parallelism on multiprocessor
- ✗ Blocking still a problem!!!



Scheduler Activations

- First proposed by [Anderson et al. 91]
- Idea: Both schedulers co-operate
 - User scheduler uses system calls
 - **Kernel scheduler uses upcalls!**
- Two important concepts
 - Upcalls
 - Notify the user-level of kernel scheduling events
 - Activations
 - A new structure to support upcalls and execution
 - approximately a kernel thread
 - As many running activations as (allocated) processors
 - Kernel controls activation creation and destruction



Scheduler Activations

- Instead of **CPU time wasted**

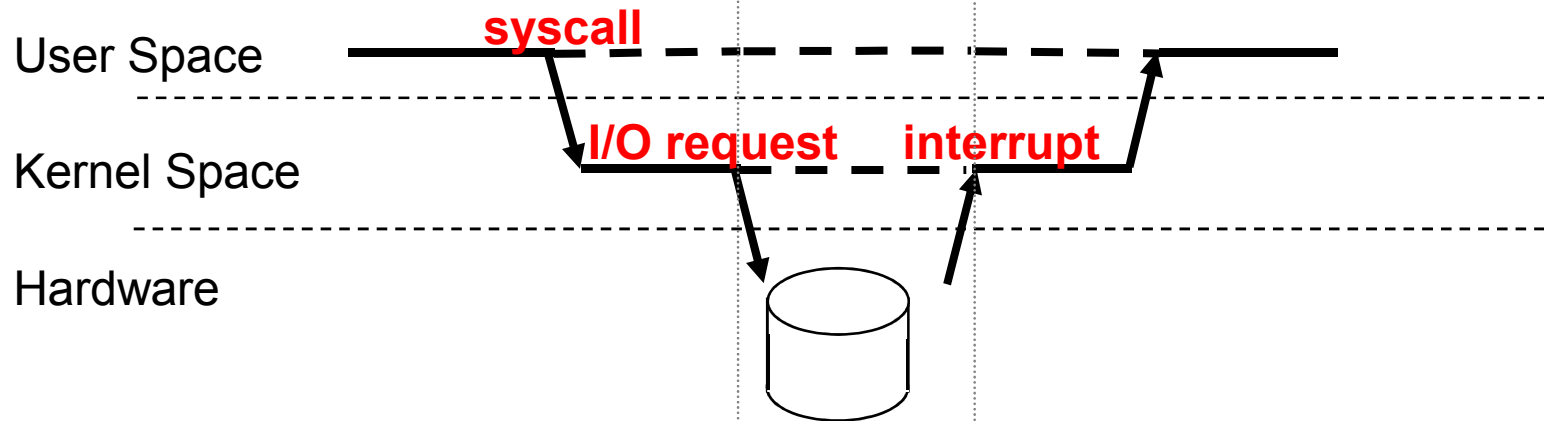

- ...rather use the following scheme:

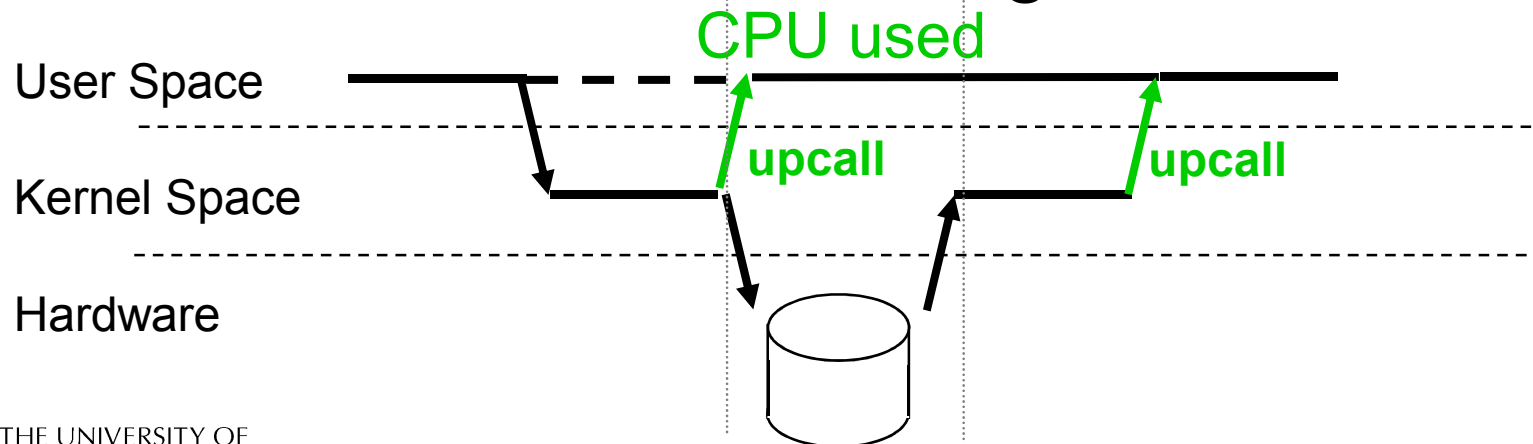

Upcalls to User-level scheduler

- **New**
 - Allocated a new virtual CPU
 - Can schedule a user-level thread
- **Preempted**
 - Deallocated a virtual CPU
 - Can schedule one less thread
- **Blocked**
 - Notifies thread has blocked
 - Can schedule another user-level thread
- **Unblocked**
 - Notifies a thread has become runnable
 - Must decided to continue current or unblocked thread



Working principle

- Blocking syscall scenario on 2 processors

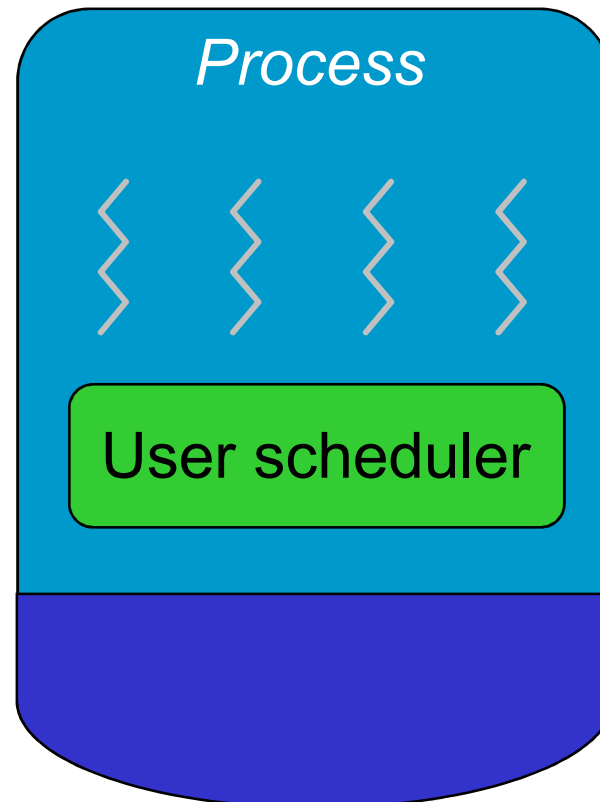

Working principle

- Blocking syscall scenario on 2 processors

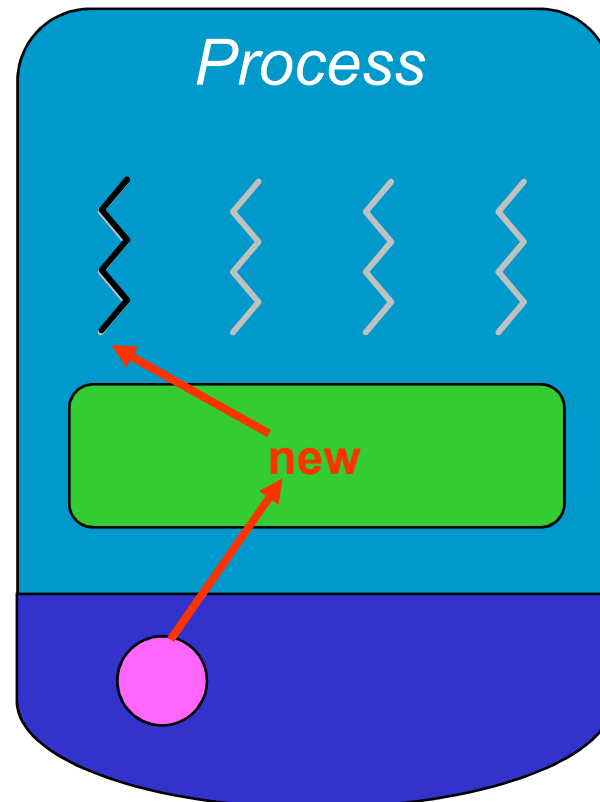

Working principle

- Blocking syscall scenario on 2 processors

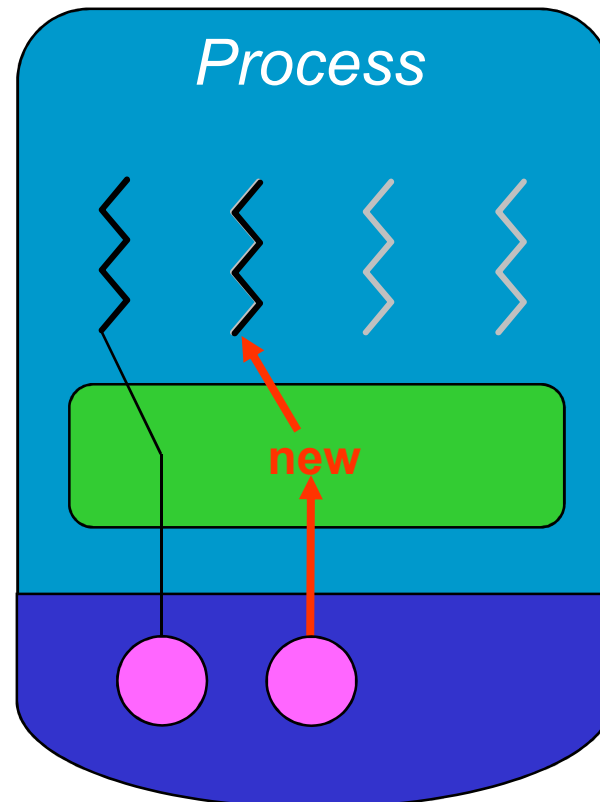

Working principle

- Blocking syscall scenario on 2 processors

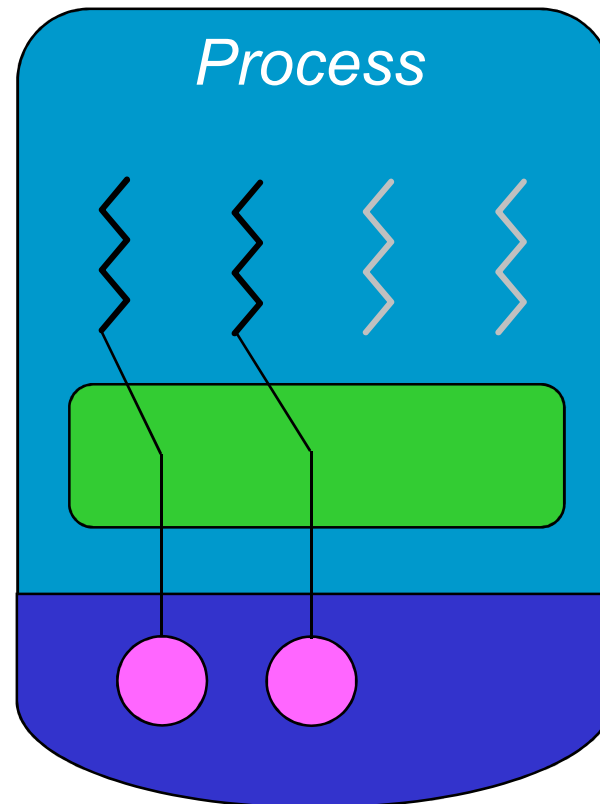

Working principle

- Blocking syscall scenario on 2 processors

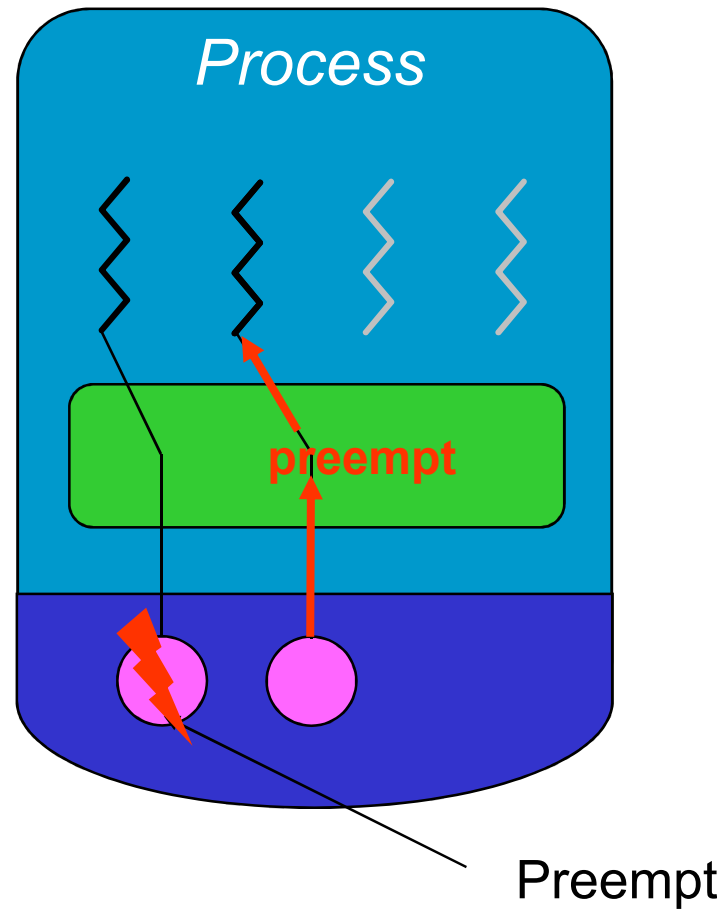

Working principle

- Blocking syscall scenario on 2 processors

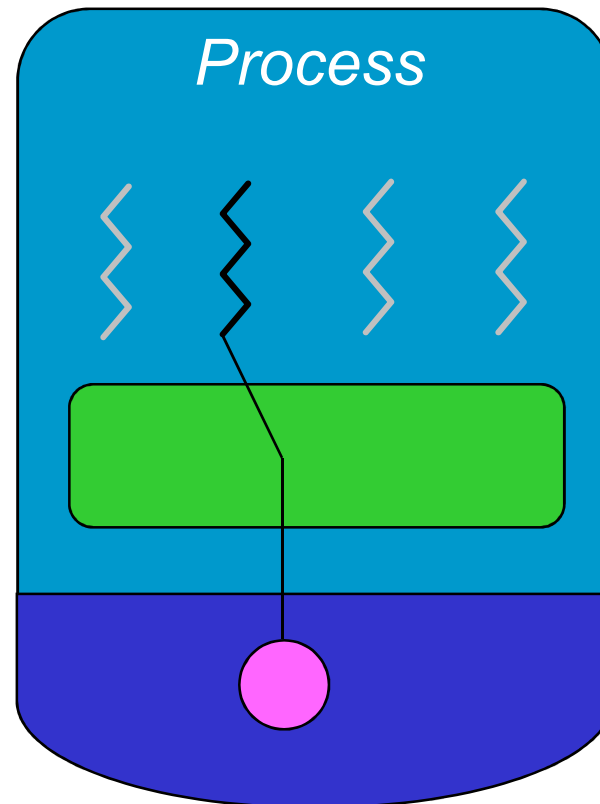

Working principle

- Blocking syscall scenario on 2 processors

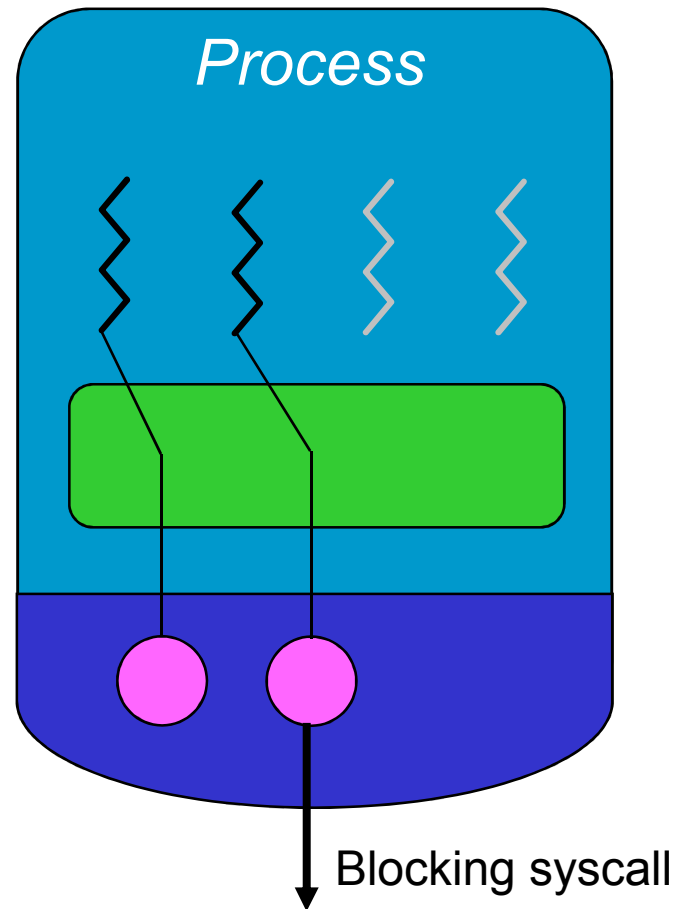

Working principle

- Blocking syscall scenario on 2 processors

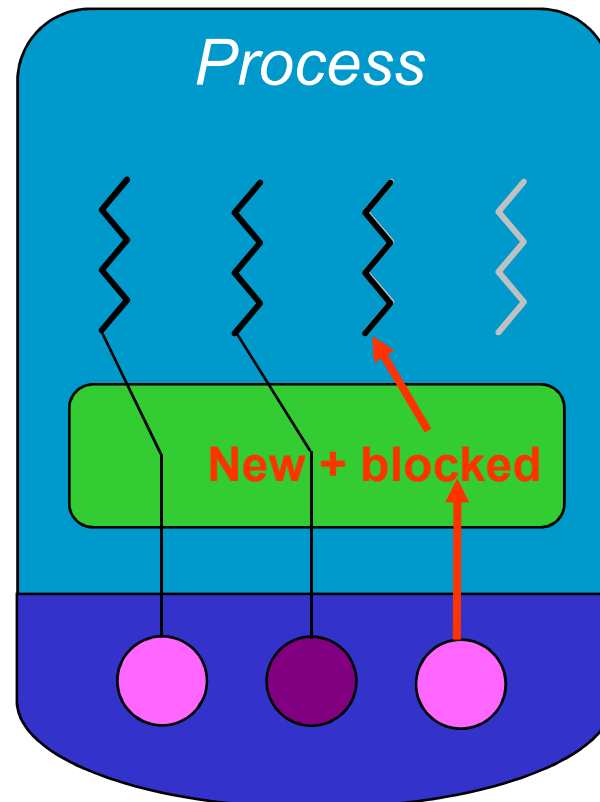

Working principle

- Blocking syscall scenario on 2 processors

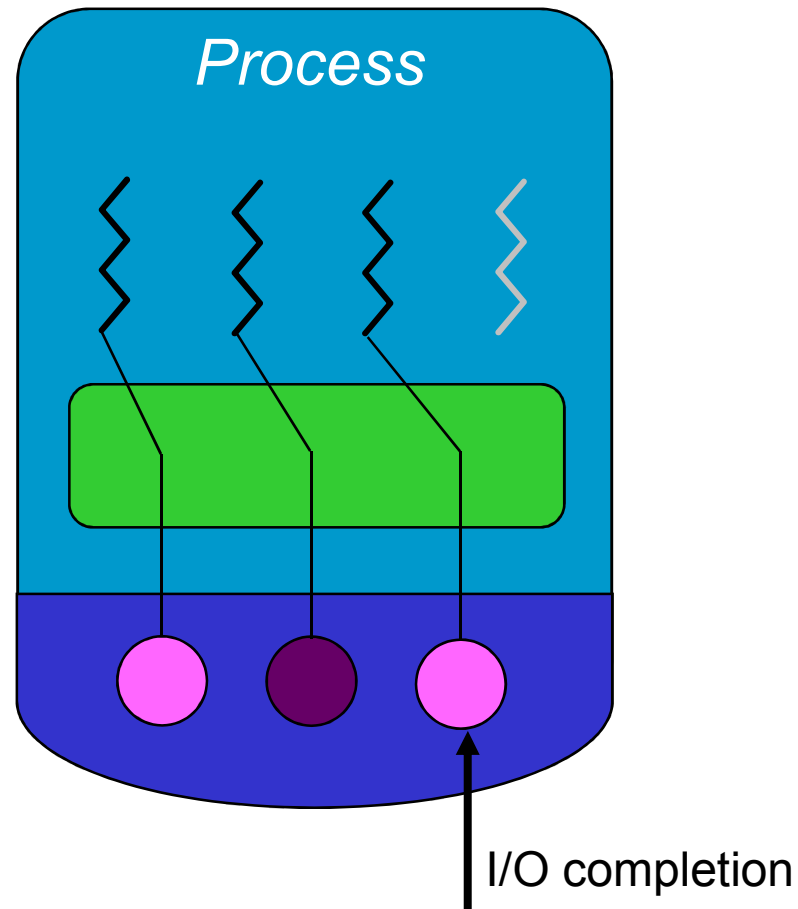

Working principle

- Blocking syscall scenario on 2 processors

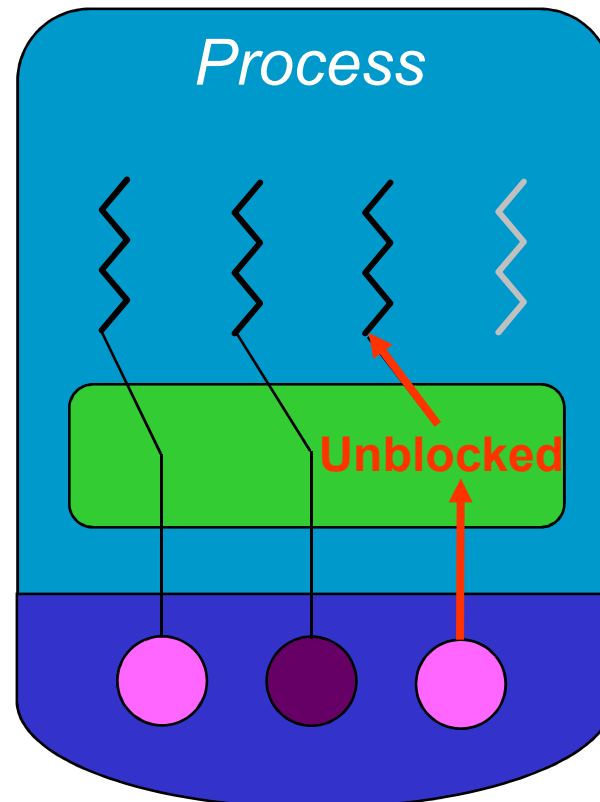

Working principle

- Blocking syscall scenario on 2 processors

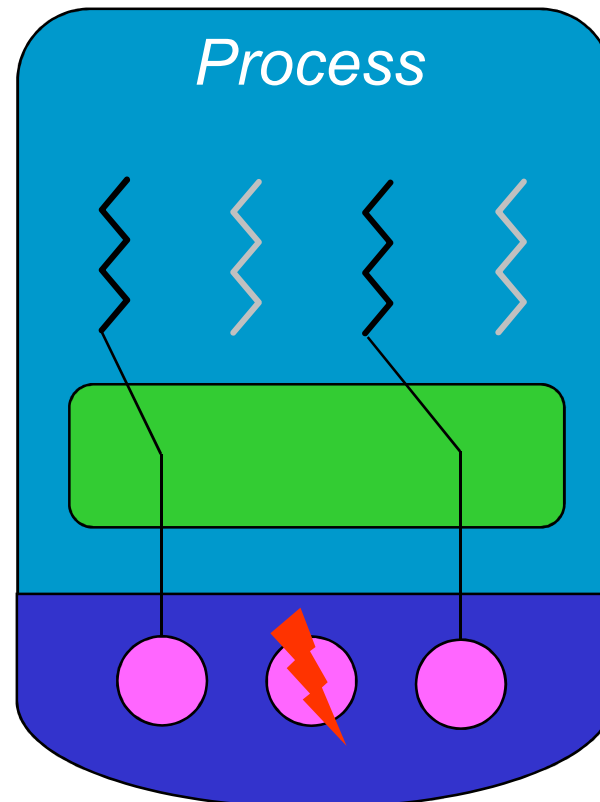

Scheduler Activations

- Thread management at user-level
 - Fast
- Real thread parallelism via activations
 - Number of activations (virtual CPU) can equal CPUs
- Blocking (syscall or page fault) creates new activation
 - User-level scheduler can pick new runnable thread.
- Fewer stacks in kernel
 - Blocked activations + number of virtual CPUs

