

Processes and Threads Implementation

1

Learning Outcomes

- A basic understanding of the MIPS R3000 assembly and compiler generated code.
- An understanding of the typical implementation strategies of processes and threads
 - Including an appreciation of the trade-offs between the implementation approaches
 - Kernel-threads versus user-level threads
- A detailed understanding of “context switching”

2

MIPS R3000

- Load/store architecture
 - No instructions that operate on memory except load and store
 - Simple load/stores to/from memory from/to registers
 - Store word: `sw r4, (r5)`
 - Store contents of r4 in memory using address contained in register r5
 - Load word: `lw r3, (r7)`
 - Load contents of memory into r3 using address contained in r7
 - Delay of one instruction after load before data available in destination register
 - Must always an instruction between a load from memory and the subsequent use of the register.
- `lw, sw, lb, sb, lh, sh,...`

3

MIPS R3000

- Arithmetic and logical operations are register to register operations
 - E.g., `add r3, r2, r1`
 - No arithmetic operations on memory
- Example
 - `add r3, r2, r1` $\Rightarrow r3 = r2 + r1$
- Some other instructions
 - `add, sub, and, or, xor, sll, srl`
 - `move r2, r1` $\Rightarrow r2 = r1$

4

MIPS R3000

- All instructions are encoded in 32-bit
- Some instructions have *immediate* operands
 - Immediate values are constants encoded in the instruction itself
 - Only 16-bit value
 - Examples
 - Add Immediate: `addi r2, r1, 2048`
 - $\Rightarrow r2 = r1 + 2048$
 - Load Immediate: `li r2, 1234`
 - $\Rightarrow r2 = 1234$

5

Example code

Simple code example: `a = a + 1`

```
lw r4,32(r29) // r29 = stack pointer
li r5, 1
add r4, r4, r5
sw r4,32(r29)
```

Offset(Address)

6

MIPS Registers

- User-mode accessible registers
 - 32 general purpose registers
 - r0 hardwired to zero
 - r31 the *link* register for jump-and-link (JAL) instruction
 - HI/LO
 - 2 * 32-bits for multiply and divide
 - PC
 - Not directly visible
 - Modified implicitly by jump and branch instructions

7

Branching and Jumping

- Branching and jumping have a *branch delay slot*
 - The instruction following a branch or jump is always executed prior to destination of jump

```

li    r2, 1
sw    r0, (r3)
j     1f
li    r2, 2
li    r2, 3
1:   sw    r2, (r3)
  
```

8

MIPS R3000

- RISC architecture – 5 stage pipeline
 - Instruction partially through pipeline prior to jmp having an effect

Figure 1.1. MIPS 5-stage pipeline

9

Jump and Link Instruction

- JAL is used to implement function calls
 - r31 = PC+8
- Return Address register (RA) is used to return from function call

```

:
0x10    jal  1f
0x14    nop
0x18    lw   r4, (r6)
:
1:      sw   r2, (r3)
:
0x2a    sw   r2, (r3)
:
0x38    jr  r31
0x3a    nop
  
```

10

Compiler Register Conventions

- Given 32 registers, which registers are used for
 - Local variables?
 - Argument passing?
 - Function call results?
 - Stack Pointer?

11

Compiler Register Conventions

Reg No	Name	Used for
0	zero	Always returns 0
1	at	(assembler temporary) Reserved for use by assembler
2-3	v0-v1	Value (except FP) returned by subroutine
4-7	a0-a3	(arguments) First four parameters for a subroutine
8-15	t0-t7	(temporaries) subroutines may use without saving
24-25	t8-t9	
16-23	s0-s7	Subroutine "register variables"; a subroutine which will write one of these must save the old value and restore it before it exits, so the <i>calling</i> routine sees their values preserved.
26-27	k0-k1	Reserved for use by interrupt/trap handler - may change under your feet
28	gp	global pointer - some runtime systems maintain this to give easy access to (some) "static" or "extern" variables.
29	sp	stack pointer
30	s8/tp	9th register variable. Subroutines which need one can use this as a "frame pointer".
31	ra	Return address for subroutine

12

Simple factorial

```

int fact(int n)          0: 1880000b    blez  a0,30 <fact+0x30>
{
  int r = 1;             4: 24840001    addiu a0,a0,1
  int i;                8: 24030001    li    v1,1
                      c: 24020001    li    v0,1
                      10: 00430018   mult  v0,v1
  for (i = 1; i < n+1; i++) {
    r = r * i;          14: 24630001   addiu v1,v1,1
                      18: 00001012   mflo  v0
  }
  return r;             1c: 00000000   nop
                      20: 1464ffff   bne   v1,a0,14 <fact+0x14>
}                       24: 00430018   mult  v0,v1
                      28: 03e00008   jr    ra
                      2c: 00000000   nop
                      30: 03e00008   jr    ra
                      34: 24020001    li    v0,1

```

13 UNSW

13

Function Stack Frames

- Each function call allocates a new stack frame for local variables, the return address, previous frame pointer etc.
 - Frame pointer: start of current stack frame
 - Stack pointer: end of current stack frame
- Example: assume f1() calls f2(), which calls f3().

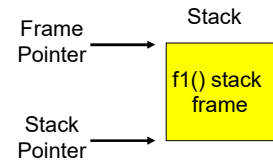

14 UNSW

14

Function Stack Frames

- Each function call allocates a new stack frame for local variables, the return address, previous frame pointer etc.
 - Frame pointer: start of current stack frame
 - Stack pointer: end of current stack frame
- Example: assume f1() calls f2(), which calls f3().

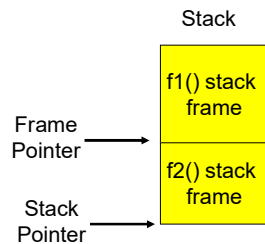

15 UNSW

15

Function Stack Frames

- Each function call allocates a new stack frame for local variables, the return address, previous frame pointer etc.
 - Frame pointer: start of current stack frame
 - Stack pointer: end of current stack frame
- Example: assume f1() calls f2(), which calls f3().

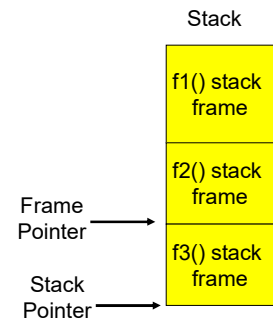

16 UNSW

16

Stack Frame

- MIPS calling convention for gcc
 - Args 1-4 have space reserved for them

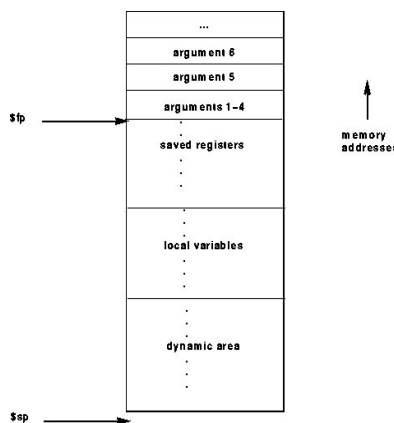

17 UNSW

17

Example Code

```

main ()
{
  int i;

  i =
  sixargs (1,2,3,4,5,6);
}

int sixargs(int a, int
b, int c, int d, int e,
int f)
{
  return a + b + c + d
    + e + f;
}

```

18 UNSW

18

```

0040011c <main>:
40011c: 27bdfdf8   addiu sp,sp,-40
400120: afbf0024   sw   ra,36(sp)
400124: afbe0020   sw   s8,32(sp)
400128: 03a0f021   move s8,sp
40012c: 24020005   li   v0,5
400130: afa20010   sw   v0,16(sp)
400134: 24020006   li   v0,6
400138: afa20014   sw   v0,20(sp)
40013c: 24040001   li   a0,1
400140: 24050002   li   a1,2
400144: 24060003   li   a2,3
400148: 0c10002c   jal  4000b0 <sixargs>
40014c: 24070004   li   a3,4
400150: afc20018   sw   v0,24(s8)
400154: 03c0e821   move sp,s8
400158: 8fbf0024   lw   ra,36(sp)
40015c: 8fbe0020   lw   s8,32(sp)
400160: 03e00008   jr   ra
400164: 27bd0028   addiu sp,sp,40
...

```

19



```

004000b0 <sixargs>:
4000b0: 27bdfdf8   addiu sp,sp,-8
4000b4: afbe0000   sw   s8,0(sp)
4000b8: 03a0f021   move s8,sp
4000bc: afc40008   sw   a0,8(s8)
4000c0: afc5000c   sw   a1,12(s8)
4000c4: afc60010   sw   a2,16(s8)
4000c8: afc70014   sw   a3,20(s8)
4000cc: 8fc30008   lw   v1,8(s8)
4000d0: 8fc2000c   lw   v0,12(s8)
4000d4: 00000000   nop
4000d8: 00621021   addu v0,v1,v0
4000dc: 8fc30010   lw   v1,16(s8)
4000e0: 00000000   nop
4000e4: 00431021   addu v0,v0,v1
4000e8: 8fc30014   lw   v1,20(s8)
4000ec: 00000000   nop
4000f0: 00431021   addu v0,v0,v1
4000f4: 8fc30018   lw   v1,24(s8)
4000f8: 00000000   nop

```

20



```

4000fc: 00431021   addu v0,v0,v1
400100: 8fc3001c   lw   v1,28(s8)
400104: 00000000   nop
400108: 00431021   addu v0,v0,v1
40010c: 03c0e821   move sp,s8
400110: 8fbf0000   lw   s8,0(sp)
400114: 03e00008   jr   ra
400118: 27bd0008   addiup,sp,8

```

21

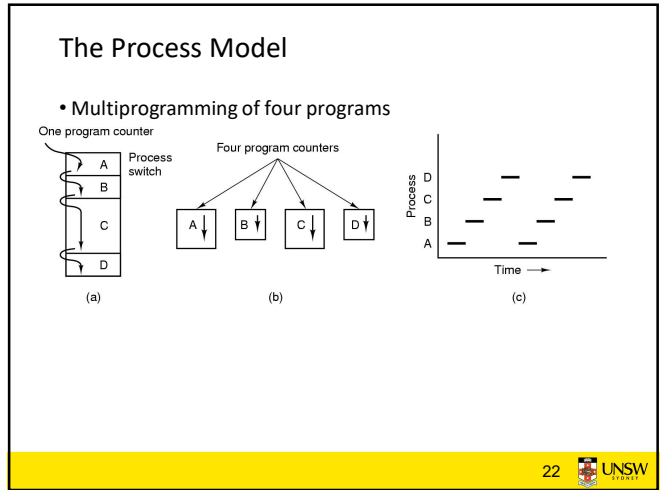

22



Process

- Minimally consist of three segments
 - Text
 - contains the code (instructions)
 - Data
 - Global variables
 - Stack
 - Activation records of procedure/function/method
 - Local variables
- Note:
 - data can dynamically grow up
 - E.g., malloc()-ing
 - The stack can dynamically grow down
 - E.g., increasing function call depth or recursion

Process Memory Layout

The diagram shows a vertical stack of memory segments: Stack (top, with a downward arrow), Gap (middle), Data (bottom, with an upward arrow), and Text (bottom-most).

23

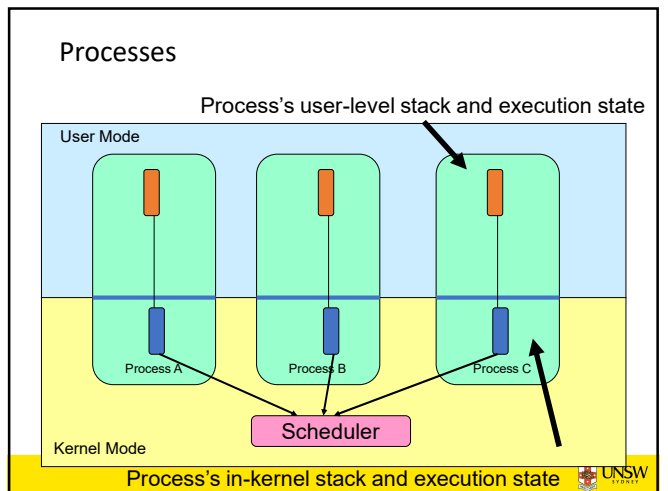

24



Processes

- User-mode
 - Processes (programs) scheduled by the kernel
 - Isolated from each other
 - No concurrency issues between each other
- System-calls transition into and return from the kernel
- Kernel-mode
 - Nearly all activities still associated with a process
 - Kernel memory shared between all processes
 - Concurrency issues exist between processes concurrently executing in a system call

Threads The Thread Model

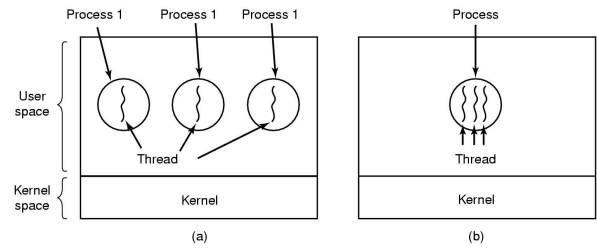

(a) Three processes each with one thread
(b) One process with three threads

The Thread Model

Per process items

Address space
Global variables
Open files
Child processes
Pending alarms
Signals and signal handlers
Accounting information

Per thread items

Program counter
Registers
Stack
State

- Items shared by all threads in a process
- Items that exist per thread

The Thread Model

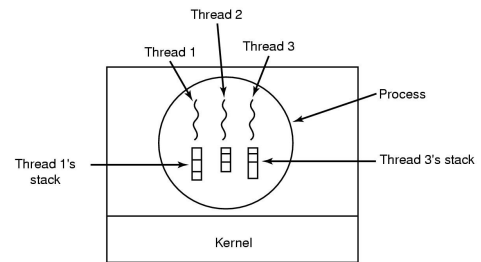

Each thread has its own stack

A Subset of POSIX threads API

```
int pthread_create(pthread_t *, const pthread_attr_t *,
    void (*)(void *), void *);
void pthread_exit(void *);

int pthread_mutex_init(pthread_mutex_t *, const pthread_mutexattr_t *);
int pthread_mutex_destroy(pthread_mutex_t *);
int pthread_mutex_lock(pthread_mutex_t *);
int pthread_mutex_unlock(pthread_mutex_t *);

int pthread_rwlock_init(pthread_rwlock_t *, const pthread_rwlockattr_t *);
int pthread_rwlock_destroy(pthread_rwlock_t *);
int pthread_rwlock_rdlock(pthread_rwlock_t *);
int pthread_rwlock_wrlock(pthread_rwlock_t *);
int pthread_rwlock_unlock(pthread_rwlock_t *);
```

Where to Implement Application Threads?

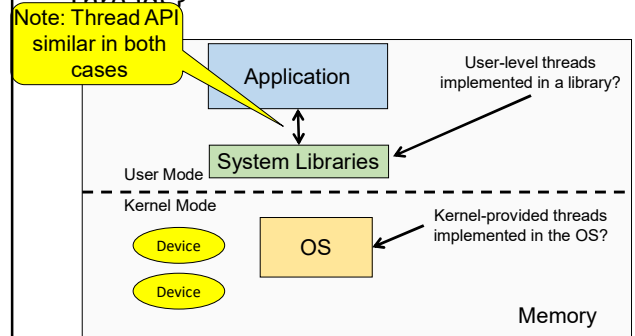

Implementing Threads in User Space

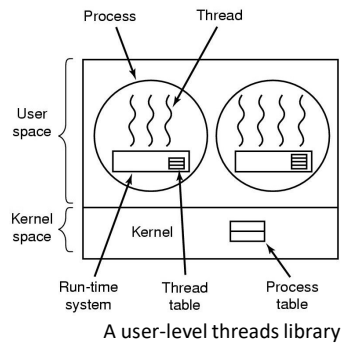

31

User-level Threads

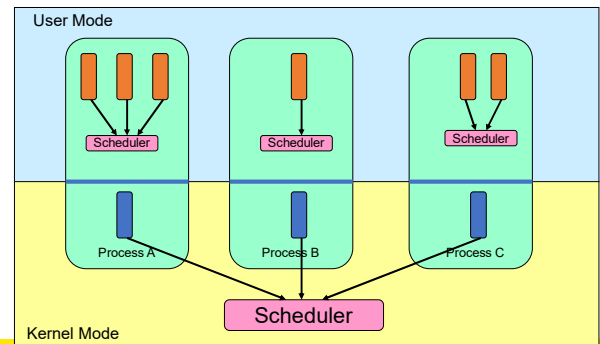

32

User-level Threads

- Implementation at user-level
 - User-level Thread Control Block (TCB), ready queue, blocked queue, and dispatcher
 - Kernel has no knowledge of the threads (it only sees a single process)
 - If a thread blocks waiting for a resource held by another thread inside the same process, its state is saved and the dispatcher switches to another ready thread
 - Thread management (create, exit, yield, wait) are implemented in a runtime support library

33

User-Level Threads

- Pros
 - Thread management and switching at user level is much faster than doing it in kernel level
 - No need to trap (take syscall exception) into kernel and back to switch
 - Dispatcher algorithm can be tuned to the application
 - E.g. use priorities
 - Can be implemented on any OS (thread or non-thread aware)
 - Can easily support massive numbers of threads on a per-application basis
 - Use normal application virtual memory
 - Kernel memory more constrained. Difficult to efficiently support wildly differing numbers of threads for different applications.

34

User-level Threads

- Cons
 - Threads have to yield() manually (no timer interrupt delivery to user-level)
 - **Co-operative multithreading**
 - A single poorly design/implemented thread can monopolise the available CPU time
 - There are work-arounds (e.g. a timer signal per second to enable pre-emptive multithreading), they are coarse grain and a kludge.
 - Does not take advantage of multiple CPUs (in reality, we still have a single threaded process as far as the kernel is concerned)

35

User-Level Threads

- Cons
 - If a thread makes a blocking system call (or takes a page fault), the process (and all the internal threads) blocks
 - Can't overlap I/O with computation

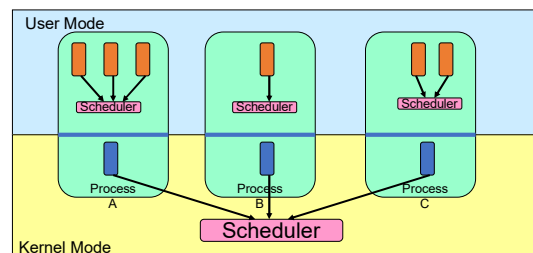

36

Implementing Threads in the Kernel

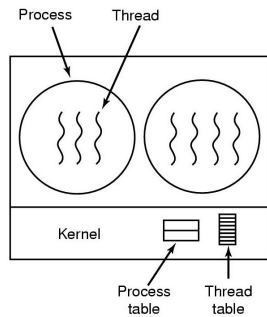

A threads package managed by the kernel

37

Kernel-provided Threads

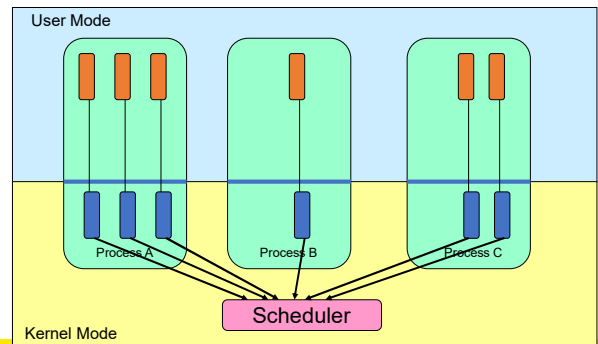

38

Kernel-provided Threads

- Also called kernel-level threads
 - Even though they provide threads to applications
- Threads are implemented by the kernel
 - TCBs are stored in the kernel
 - A subset of information in a traditional PCB
 - The subset related to execution context
 - TCBs have a PCB associated with them
 - Resources associated with the group of threads (the process)
 - Thread management calls are implemented as system calls
 - E.g. create, wait, exit

39

Kernel-provided Threads

- Cons
 - Thread creation and destruction, and blocking and unblocking threads requires kernel entry and exit.
 - More expensive than user-level equivalent

40

Kernel-provided Threads

- Pros
 - **Preemptive** multithreading
 - Parallelism
 - Can overlap blocking I/O with computation
 - Can take advantage of a multiprocessor

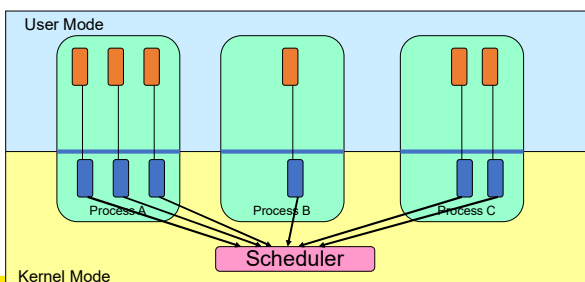

41

Multiprogramming Implementation

1. Hardware stacks program counter, etc.
2. Hardware loads new program counter from interrupt vector.
3. Assembly language procedure saves registers.
4. Assembly language procedure sets up new stack.
5. C interrupt service runs (typically reads and buffers input).
6. Scheduler decides which process is to run next.
7. C procedure returns to the assembly code.
8. Assembly language procedure starts up new current process.

Skeleton of what lowest level of OS does when an interrupt occurs – a context switch

42

Context Switch Terminology

- A context switch can refer to
 - A switch between threads
 - Involving saving and restoring of state associated with a thread
 - A switch between processes
 - Involving the above, plus extra state associated with a process.
 - E.g. memory maps

Context Switch Occurrence

- A switch between process/threads can happen any time the OS is invoked
 - On a system call
 - Mandatory if system call blocks or on exit();
 - On an exception
 - Mandatory if offender is killed
 - On an interrupt
 - Triggering a dispatch is the main purpose of the *timer interrupt*

A thread switch can happen between any two instructions

Note instructions do not equal program statements

Context Switch

- Context switch must be *transparent* for processes/threads
 - When dispatched again, process/thread should not notice that something else was running in the meantime (except for elapsed time)
- ⇒ OS must save all state that affects the thread
- This state is called the *process/thread context*
- Switching between process/threads consequently results in a *context switch*.

Simplified Explicit Thread Switch

Assume Kernel-Level Threads

Lets focus on user->kernel – switch – kernel -> user

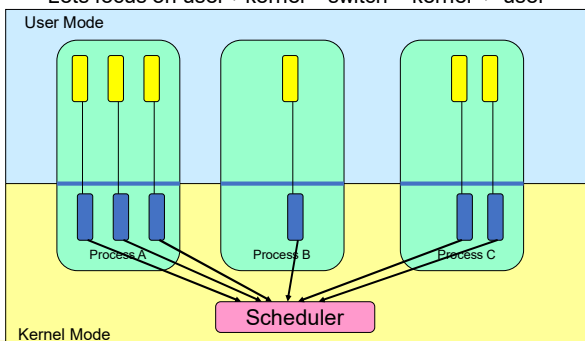

Example Context Switch

- Running in user mode, SP points to user-level stack (not shown on slide)

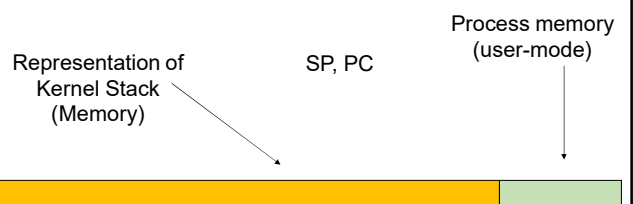

Example Context Switch

- Take an exception, syscall, or interrupt, and we switch to the kernel stack

SP, PC

49

49

Example Context Switch

- We push a *trapframe* on the stack
 - Also called *exception frame*, *user-level context*...
 - Includes the user-level PC and SP

SP

50

50

Example Context Switch

- Call 'C' code to process syscall, exception, or interrupt
 - Results in a 'C' activation stack building up

SP

51

51

Example Context Switch

- The kernel decides to perform a context switch
 - It chooses a target thread (or process)
 - It pushes remaining kernel context onto the stack

SP

52

52

Example Context Switch

- Any other existing thread must
 - be in kernel mode (on a uni processor),
 - and have a similar stack layout to the stack we are currently using

SP

Kernel stacks of other threads/processes

53

53

Example Context Switch

- We save the current SP in the PCB (or TCB), and load the SP of the target thread.
 - Thus we have *switched contexts*

SP

54

54

Example Context Switch

- Load the target thread's previous context, and return to C

SP

55 UNSW

55

Example Context Switch

- The C continues and (in this example) returns to user mode.

SP

56 UNSW

56

Example Context Switch

- The user-level context is restored
 - The registers load with that processes previous content

SP

57 UNSW

57

Example Context Switch

- The user-level SP and PC is restored

PC, SP

58 UNSW

58

The Interesting Part of a Thread Switch

- What does the “push kernel state” part do???

SP

59 UNSW

59

Simplified OS/161 thread_switch

```

static
void
thread_switch(threadstate_t newstate, struct wchan *wc)
{
    struct thread *cur, *next;

    cur = curthread;
    do {
        next = threadlist_remhead(&curcpu->c_runqueue);
        if (next == NULL) {
            cpu_idle();
        }
    } while (next == NULL);

    /* do the switch (in assembler in switch.S) */
    switchframe_switch(&cur->t_context, &next->t_context);
}

```

Lots of code removed – only basics of pick next thread and switch to it remain

58 UNSW

60

OS/161 switchframe_switch

```
switchframe_switch:
/*
 * a0 contains the address of the switchframe pointer in the old thread.
 * a1 contains the address of the switchframe pointer in the new thread.
 *
 * The switchframe pointer is really the stack pointer. The other
 * registers get saved on the stack, namely:
 *
 * * s0-s6, s8
 * * gp, ra
 *
 * The order must match <mips/switchframe.h>.
 *
 * Note that while we'd ordinarily need to save s7 too, because we
 * use it to hold curthread saving it would interfere with the way
 * curthread is managed by thread.c. So we'll just let thread.c
 * manage it.
 */
```

61 UNSW

61

OS/161 switchframe_switch

```
/* Allocate stack space for saving 10 registers. 10*4 = 40 */
addi sp, sp, -40

/* Save the registers */
sw ra, 36(sp)
sw gp, 32(sp)
sw s8, 28(sp)
sw s6, 24(sp)
sw s5, 20(sp)
sw s4, 16(sp)
sw s3, 12(sp)
sw s2, 8(sp)
sw s1, 4(sp)
sw s0, 0(sp)

/* Store the old stack pointer in the old thread */
sw sp, 0(a0)
```

Save the registers that the 'C' procedure calling expects preserved

62 UNSW

62

OS/161 switchframe_switch

```
/* Get the new stack pointer from the new thread */
lw sp, 0(a1)
nop /* delay slot for load */

/* Now, restore the registers */
lw s0, 0(sp)
lw s1, 4(sp)
lw s2, 8(sp)
lw s3, 12(sp)
lw s4, 16(sp)
lw s5, 20(sp)
lw s6, 24(sp)
lw s8, 28(sp)
lw gp, 32(sp)
lw ra, 36(sp)
nop /* delay slot for load */
```

63 UNSW

63

OS/161 switchframe_switch

```
/* and return. */
j ra
addi sp, sp, 40 /* in delay slot */
```

64 UNSW

64

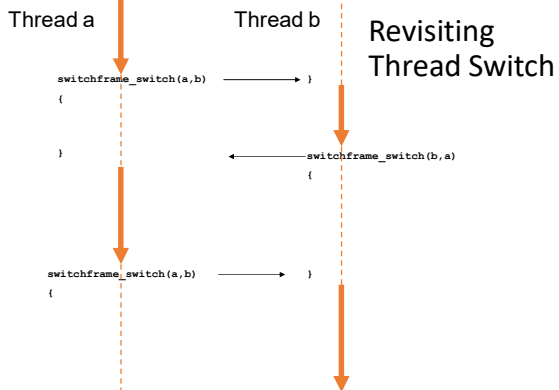

65 UNSW

65