

System Calls

Interface and Implementation

Learning Outcomes

- A high-level understanding of *System Call* interface
 - Mostly from the user's perspective
 - From textbook (section 1.6)
- Understanding of how the application-kernel boundary is crossed with system calls in general
 - Including an appreciation of the relationship between a case study (OS/161 system call handling) and the general case.
- Exposure architectural details of the MIPS R3000
 - Detailed understanding of the of exception handling mechanism
 - From “Hardware Guide” on class web site

System Calls

Interface

The Structure of a Computer System

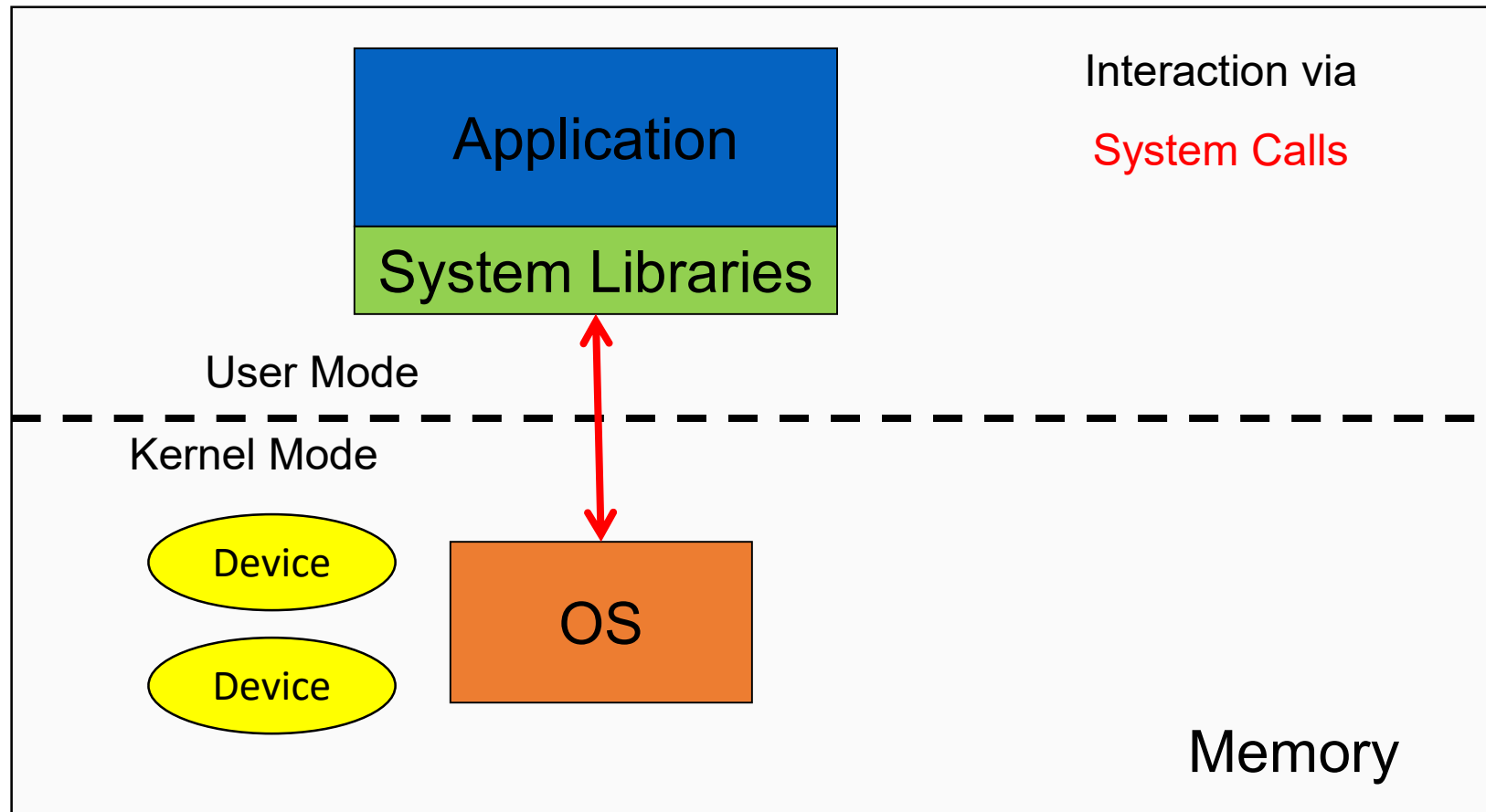

System Calls

- Can be viewed as special function calls
 - Provides for a controlled entry into the kernel
 - While in kernel, they perform a privileged operation
 - Returns to original caller with the result
- The system call interface represents the abstract machine provided by the operating system.

The System Call Interface: A Brief Overview

- From the user's perspective
 - Process Management
 - File I/O
 - Directories management
 - Some other selected Calls
 - There are many more
 - On Linux, see `man syscalls` for a list

Some System Calls For Process Management

Process management

Call	Description
<code>pid = fork()</code>	Create a child process identical to the parent
<code>pid = waitpid(pid, &statloc, options)</code>	Wait for a child to terminate
<code>s = execve(name, argv, environp)</code>	Replace a process' core image
<code>exit(status)</code>	Terminate process execution and return status

Some System Calls For File Management

File management

Call	Description
<code>fd = open(file, how, ...)</code>	Open a file for reading, writing or both
<code>s = close(fd)</code>	Close an open file
<code>n = read(fd, buffer, nbytes)</code>	Read data from a file into a buffer
<code>n = write(fd, buffer, nbytes)</code>	Write data from a buffer into a file
<code>position = lseek(fd, offset, whence)</code>	Move the file pointer
<code>s = stat(name, &buf)</code>	Get a file's status information

System Calls

- A stripped down shell:

```
while (TRUE) {
    type_prompt( );
    read_command (command, parameters)

    if (fork() != 0) {
        /* Parent code */
        waitpid( -1, &status, 0);
    } else {
        /* Child code */
        execve (command, parameters, 0);
    }
}
```

/* repeat forever */

/* display prompt */

/* input from terminal */

/* fork off child process */

/* wait for child to exit */

/* execute command */

System Calls

UNIX	Win32	Description
fork	CreateProcess	Create a new process
waitpid	WaitForSingleObject	Can wait for a process to exit
execve	(none)	CreateProcess = fork + execve
exit	ExitProcess	Terminate execution
open	CreateFile	Create a file or open an existing file
close	CloseHandle	Close a file
read	ReadFile	Read data from a file
write	WriteFile	Write data to a file
lseek	SetFilePointer	Move the file pointer
stat	GetFileAttributesEx	Get various file attributes
mkdir	CreateDirectory	Create a new directory
rmdir	RemoveDirectory	Remove an empty directory
link	(none)	Win32 does not support links
unlink	DeleteFile	Destroy an existing file
mount	(none)	Win32 does not support mount
umount	(none)	Win32 does not support mount
chdir	SetCurrentDirectory	Change the current working directory
chmod	(none)	Win32 does not support security (although NT does)
kill	(none)	Win32 does not support signals
time	GetLocalTime	Get the current time

Some Win32 API calls

System Call Implementation

Crossing user-kernel boundary

A Simple Model of CPU Computation

- The fetch-execute cycle

- Load memory contents from address in program counter (PC)
 - The instruction
- Execute the instruction
- Increment PC
- Repeat

CPU Registers

PC: 0x0300

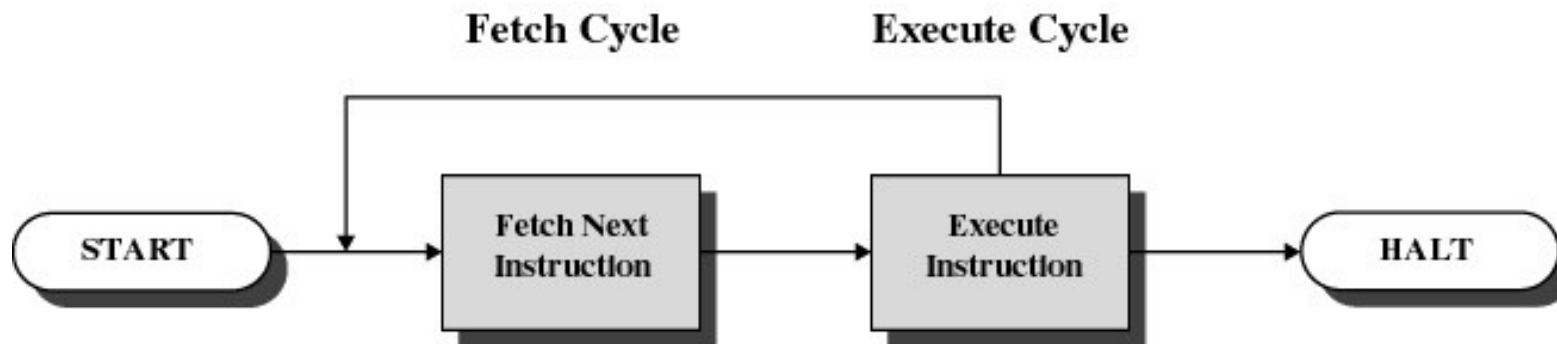

A Simple Model of CPU Computation

- Stack Pointer (SP)
- Status Register
 - Condition codes
 - Positive result
 - Zero result
 - Negative result
- General Purpose Registers
 - Holds operands of most instructions
 - Enables programmers (compiler) to minimise memory references.

CPU Registers

PC: 0x0300
SP: 0xcbf3
Status
R1
↓
Rn

Privileged-mode Operation

- To protect operating system execution, two or more CPU modes of operation exist
 - Privileged mode (system-, kernel-mode)
 - All instructions and registers are available
 - User-mode
 - Uses 'safe' subset of the instruction set
 - Only affects the state of the application itself
 - They cannot be used to uncontrollably interfere with OS
 - Only 'safe' registers are accessible

CPU Registers

Interrupt Mask
Exception Type
MMU regs
Others
PC: 0x0300
SP: 0xcbf3
Status
R1
↑ ↓
Rn

Example Unsafe Instruction

- “cli” instruction on x86 architecture
 - Disables interrupts

- Example exploit

```
cli /* disable interrupts */  
while (true)  
    /* loop forever */;
```

Privileged-mode Operation

- The accessibility of addresses within an address space changes depending on operating mode
 - To protect kernel code and data
- Note: The exact memory ranges are usually configurable, and vary between CPU architectures and/or operating systems.

Memory Address Space

0xFFFFFFFF

Accessible only
to
Kernel-mode

0x80000000

Accessible to
User- and
Kernel-mode

0x00000000

System Call

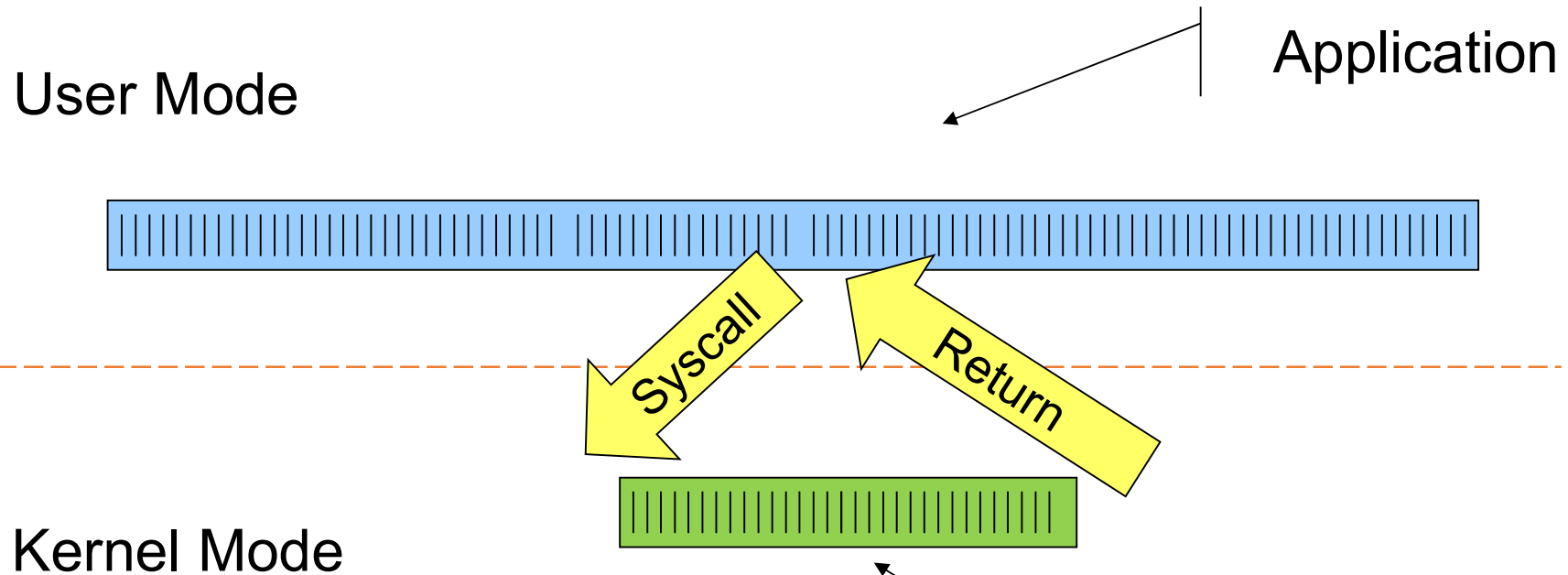

System call mechanism
securely transfers from user
execution to kernel execution
and back.

System Call
Handler

Questions we'll answer

- There is only one register set
 - How is register use managed?
 - What does an application expect a system call to look like?
- How is the transition to kernel mode triggered?
- Where is the OS entry point (system call handler)?
- How does the OS know what to do?

System Call Mechanism Overview

- System call transitions triggered by special processor instructions
 - User to Kernel
 - System call instruction
 - Kernel to User
 - Return from privileged mode instruction

System Call Mechanism Overview

- Processor mode
 - Switched from user-mode to kernel-mode
 - Switched back when returning to user mode
- Stack Pointer (SP)
 - User-level SP is saved and a kernel SP is initialised
 - User-level SP restored when returning to user-mode
- Program Counter (PC)
 - User-level PC is saved and PC set to kernel entry point
 - User-level PC restored when returning to user-level
 - Kernel entry via the designated entry point must be strictly enforced

System Call Mechanism Overview

- Registers
 - Set at user-level to indicate system call type and its arguments
 - A convention between applications and the kernel
 - Some registers are preserved at user-level or kernel-level in order to restart user-level execution
 - Depends on language calling convention etc.
 - Result of system call placed in registers when returning to user-level
 - Another convention

Why do we need system calls?

- Why not simply jump into the kernel via a function call????
 - Function calls do not
 - Change from user to kernel mode
 - and eventually back again
 - Restrict possible entry points to secure locations
 - To prevent entering after any security checks

Steps in Making a System Call

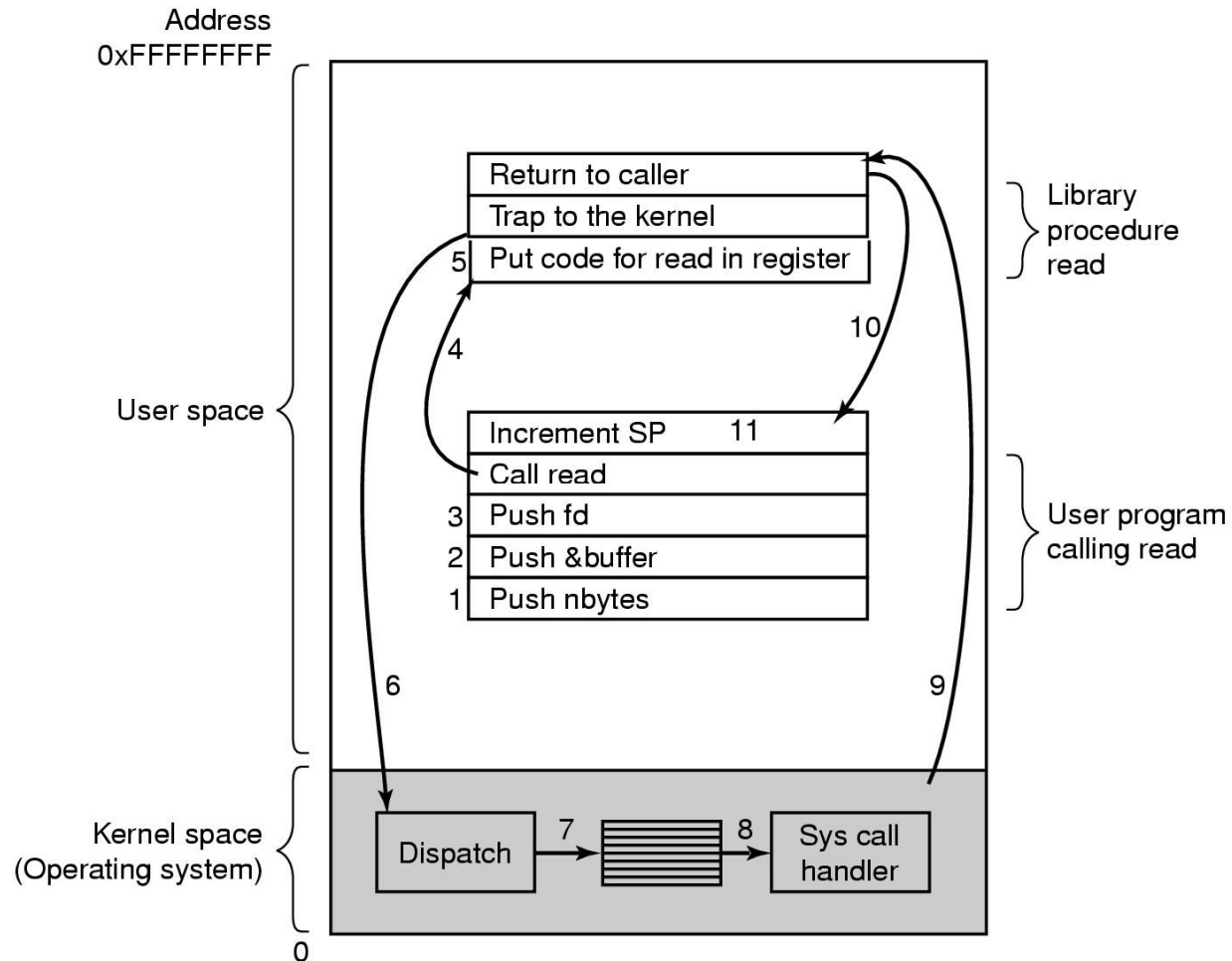

There are 11 steps in making the system call read (fd, buffer, nbytes)

The MIPS R2000/R3000

- Before looking at system call mechanics in some detail, we need a basic understanding of the MIPS R3000

Coprocessor 0

- The processor control registers are located in CP0
 - Exception/Interrupt management registers
 - Translation management registers
- CP0 is manipulated using mtc0 (move to) and mfc0 (move from) instructions
 - mtc0/mfc0 are only accessible in kernel mode.

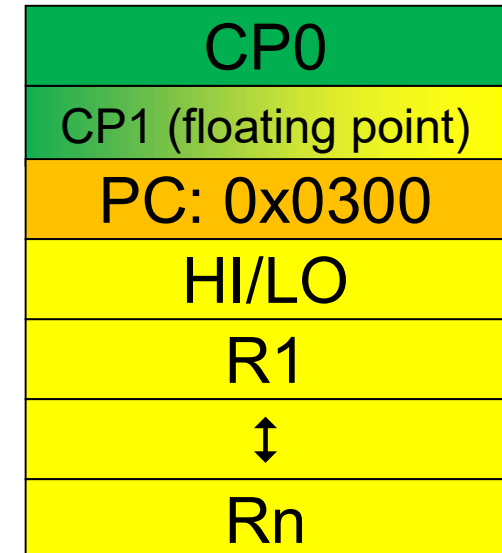

CPO Registers

- Exception Management

- `c0_cause`
 - Cause of the recent exception
- `c0_status`
 - Current status of the CPU
- `c0_epc`
 - Address of the instruction that caused the exception
- `c0_badvaddr`
 - Address accessed that caused the exception

- Miscellaneous

- `c0_prId`
 - Processor Identifier

- Memory Management

- `c0_index`
- `c0_random`
- `c0_entryhi`
- `c0_entrylo`
- `c0_context`
- More about these later in course

c0_status

31	30	29	28	27	26	25	24	23	22	21	20	19	18	17	16
CU3	CU2	CU1	CU0	0	RE	0	BEV	TS	PE	CM	PZ	SwC	IsC		
15							8	7	6	5	4	3	2	1	0
					IM			0	KUo	IEo	KUp	IEp	KUc	IEc	

Figure 3.2. Fields in status register (SR)

- For practical purposes, you can ignore most bits
 - Green background is the focus

c0_status

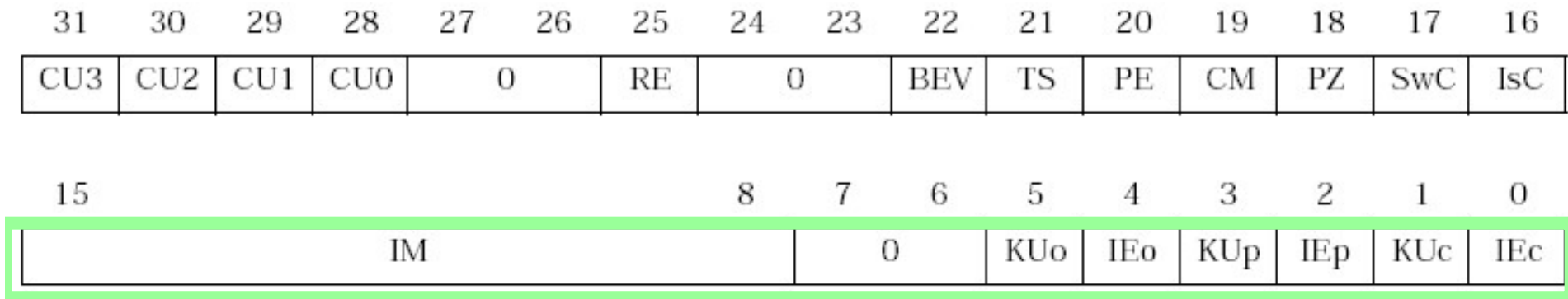

Figure 3.2. Fields in status register (SR)

- IM
 - Individual interrupt mask bits
 - 6 external
 - 2 software
- KU
 - 0 = kernel
 - 1 = user mode
- IE
 - 0 = all interrupts masked
 - 1 = interrupts enable
 - Mask determined via IM bits
- c, p, o = current, previous, old

c0_cause

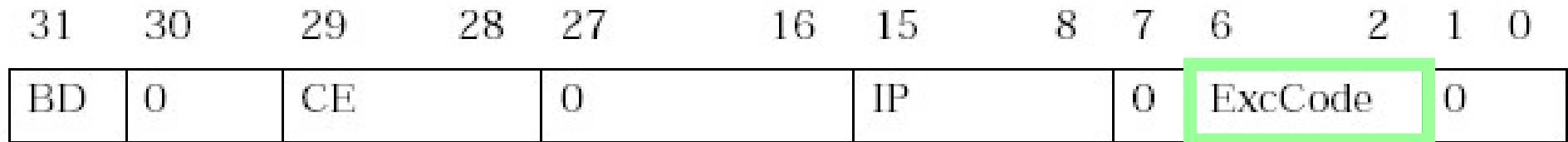

Figure 3.3. Fields in the Cause register

- IP
 - Interrupts pending
 - 8 bits indicating current state of interrupt lines
- CE
 - Coprocessor error
 - Attempt to access disabled Copro.
- BD
 - If set, the instruction that caused the exception was in a branch delay slot
- ExcCode
 - The code number of the exception taken

Exception Codes

ExcCode Value	Mnemonic	Description
0	Int	Interrupt
1	Mod	"TLB modification"
2	TLBL	"TLB load/TLB store"
3	TLBS	
4	AdEL	Address error (on load/I-fetch or store respectively). Either an attempt to access outside kuseg when in user mode, or an attempt to read a word or half-word at a misaligned address.
5	AdES	

Table 3.2. ExcCode values: different kinds of exceptions

Exception Codes

ExcCode Value	Mnemonic	Description
6	IBE	Bus error (instruction fetch or data load, respectively). External hardware has signalled an error of some kind; proper exception handling is system-dependent. The R30xx family CPUs can't take a bus error on a store; the write buffer would make such an exception "imprecise".
7	DBE	
8	Syscall	Generated unconditionally by a <i>syscall</i> instruction.
9	Bp	Breakpoint - a <i>break</i> instruction.
10	RI	"reserved instruction"
11	CpU	"Co-Processor unusable"
12	Ov	"arithmetic overflow". Note that "unsigned" versions of instructions (e.g. <i>addu</i>) never cause this exception.
13-31	-	reserved. Some are already defined for MIPS CPUs such as the R6000 and R4xxx

Table 3.2. ExcCode values: different kinds of exceptions

c0_epc

- The Exception Program Counter

- Points to address of where to restart execution after handling the exception or interrupt
- Example
 - Assume `sw r3, (r4)` causes a restartable fault exception

Aside: We are ignore BD-bit in `c0_cause` which is also used in reality on rare occasions.

```
nop  
sw r3 (r4)  
nop
```

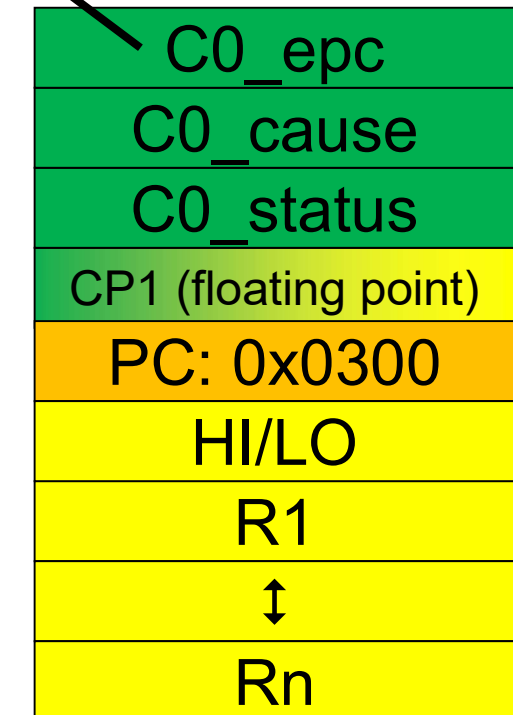

Exception Vectors

Program address	“segment”	Physical Address	Description
0x8000 0000	kseg0	0x0000 0000	TLB miss on <i>kuseg</i> reference only.
0x8000 0080	kseg0	0x0000 0080	All other exceptions.
0xbfc0 0100	kseg1	0x1fc0 0100	Uncached alternative <i>kuseg</i> TLB miss entry point (used if <i>SR</i> bit <i>BEV</i> set).
0xbfc0 0180	kseg1	0x1fc0 0180	Uncached alternative for all other exceptions, used if <i>SR</i> bit <i>BEV</i> set).
0xbfc0 0000	kseg1	0x1fc0 0000	The “reset exception”.

Table 4.1. Reset and exception entry points (vectors) for R30xx family

Simple Exception Walk-through

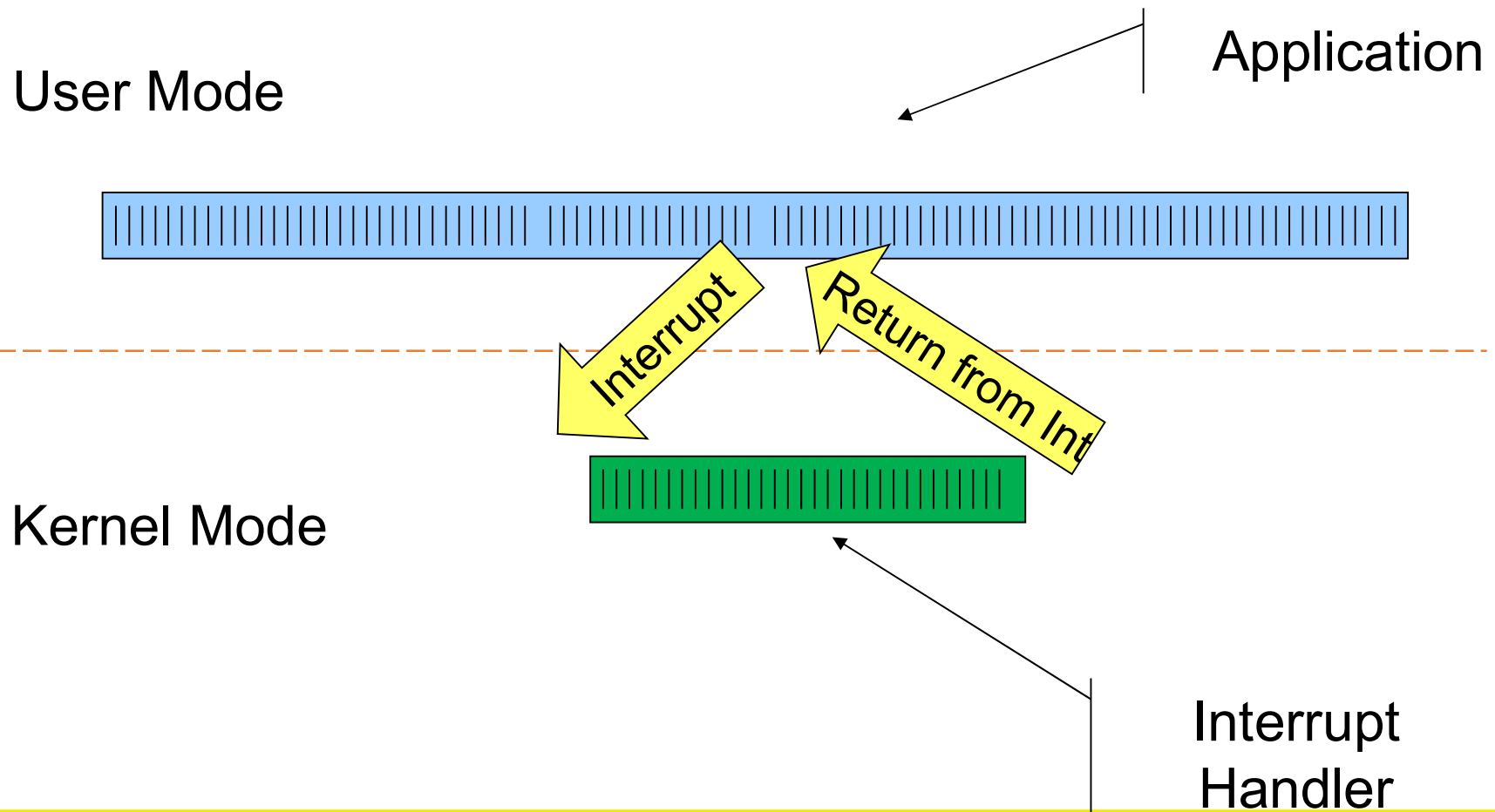

Hardware exception handling

PC

0x12345678

EPC

?

- Let's now walk through an exception

- Assume an interrupt occurred as the previous instruction completed
- Note: We are in user mode with interrupts enabled

Cause

?

Status

KUo IEo KUp IEp KUc IEc

	?	?	?	?	1	1
--	---	---	---	---	---	---

Hardware exception handling

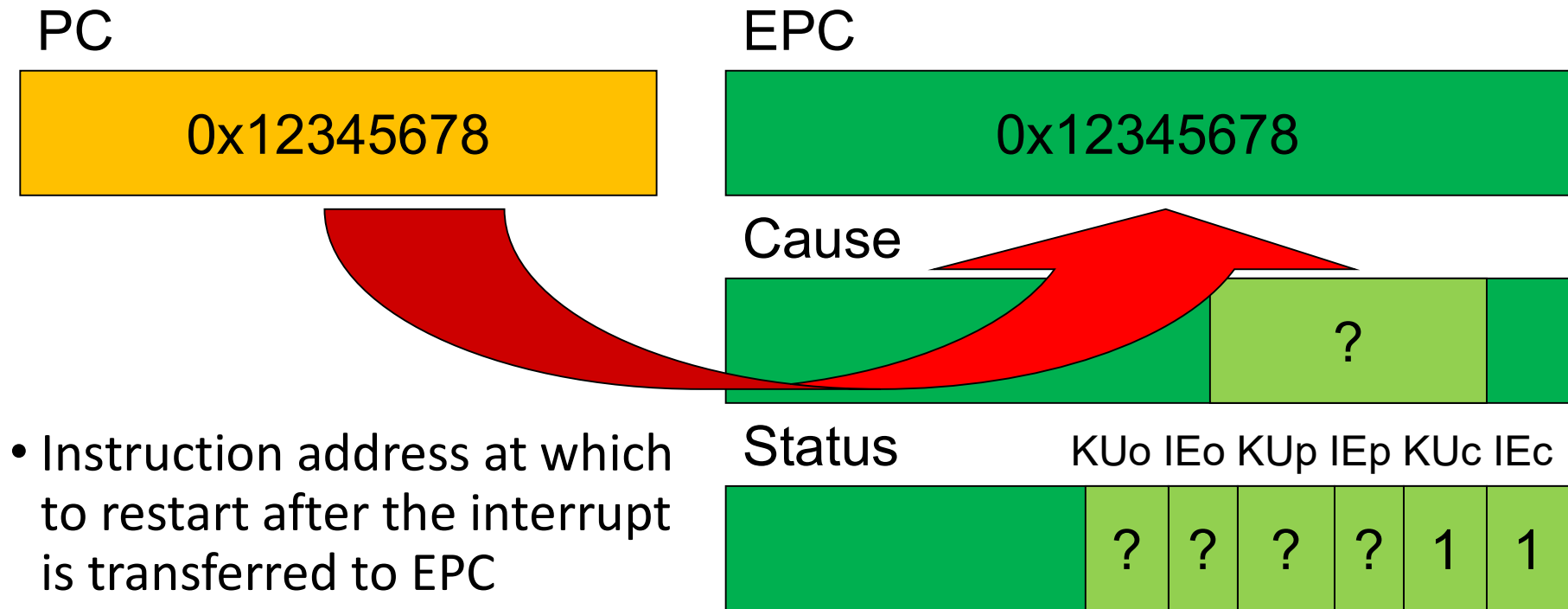

Hardware exception handling

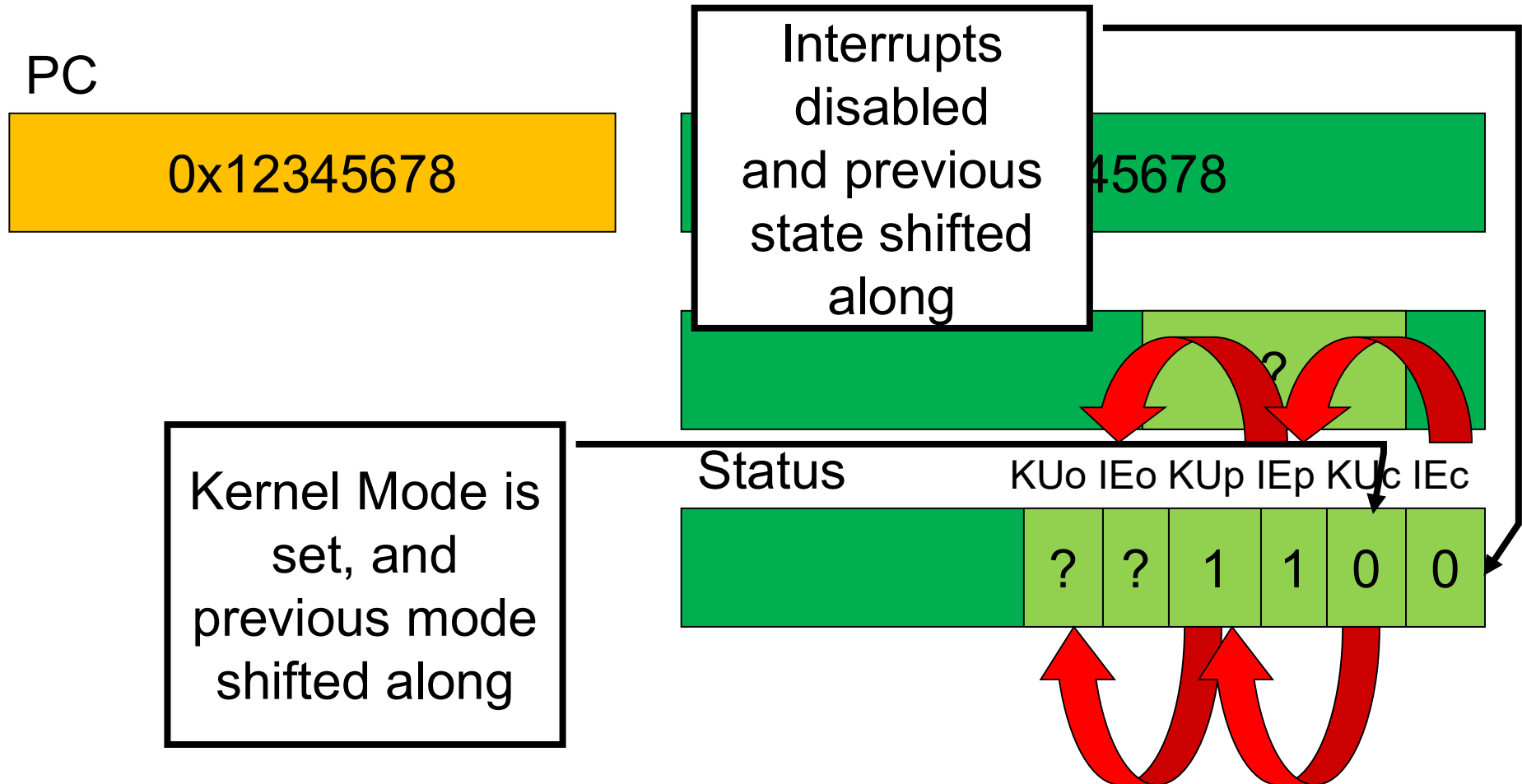

Hardware exception handling

PC

0x12345678

EPC

0x12345678

Cause

0

Status

KUo IEo KUp IEp KUc IEc

? ? 1 1 0 0

Code for the exception placed in Cause. Note Interrupt code = 0

Hardware exception handling

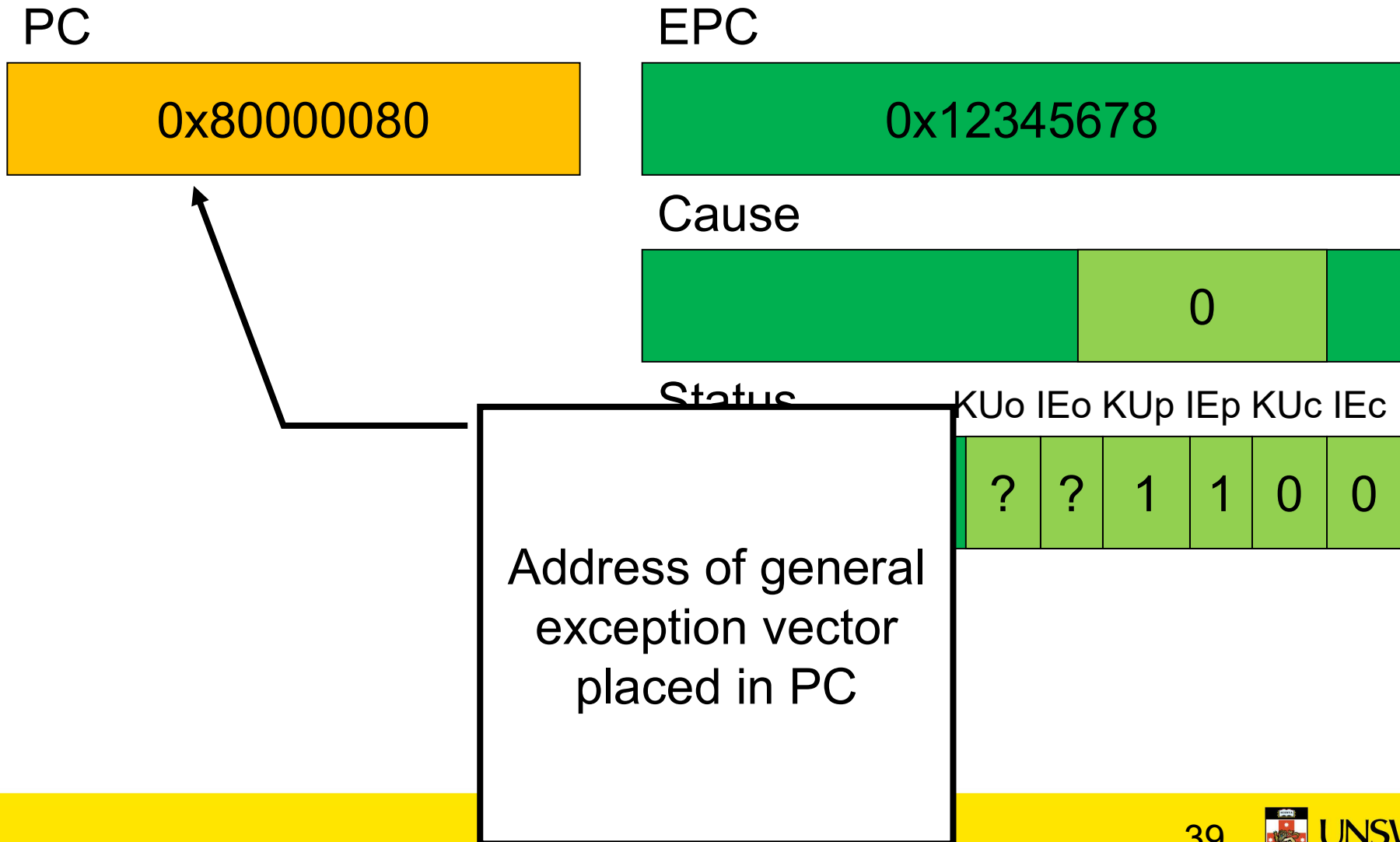

Hardware exception handling

PC

0x80000080

- CPU is now running in kernel mode at 0x80000080, with interrupts disabled
- All information required to
 - Find out what caused the exception
 - Restart after exception handling

is in coprocessor registers

EPC

0x12345678

Cause

0

Status

KUo IEo KUp IEp KUc IEc

? ? 1 1 0 0

Returning from an exception

- For now, lets ignore
 - how the exception is actually handled
 - how user-level registers are preserved
- Let's simply look at how we return from the exception

Returning from an exception

PC

0x80001234

EPC

0x12345678

- This code to return is

```
lw r27, saved_epc
nop
jr r27
rfe
```

Cause

0

Status

KUo IEo KUp IEp KUc IEc

0

Load the contents of EPC which is usually moved earlier to somewhere in memory by the exception handler

Returning from an exception

PC



EPC

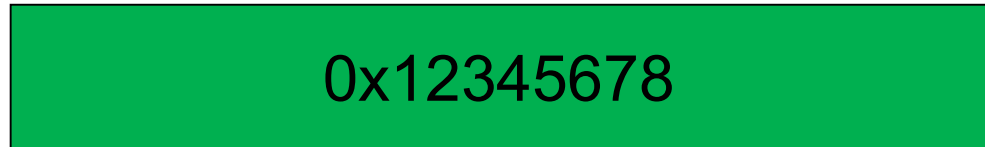

- This code to return is

```
lw r27, saved_epc
nop
jr r27
rfe
```

Cause



Status

KUp IEo KUp IEp KUc IEc

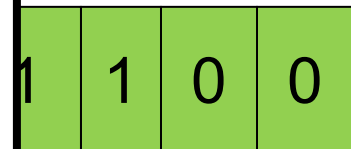

Store the EPC back in the PC

Returning from an exception

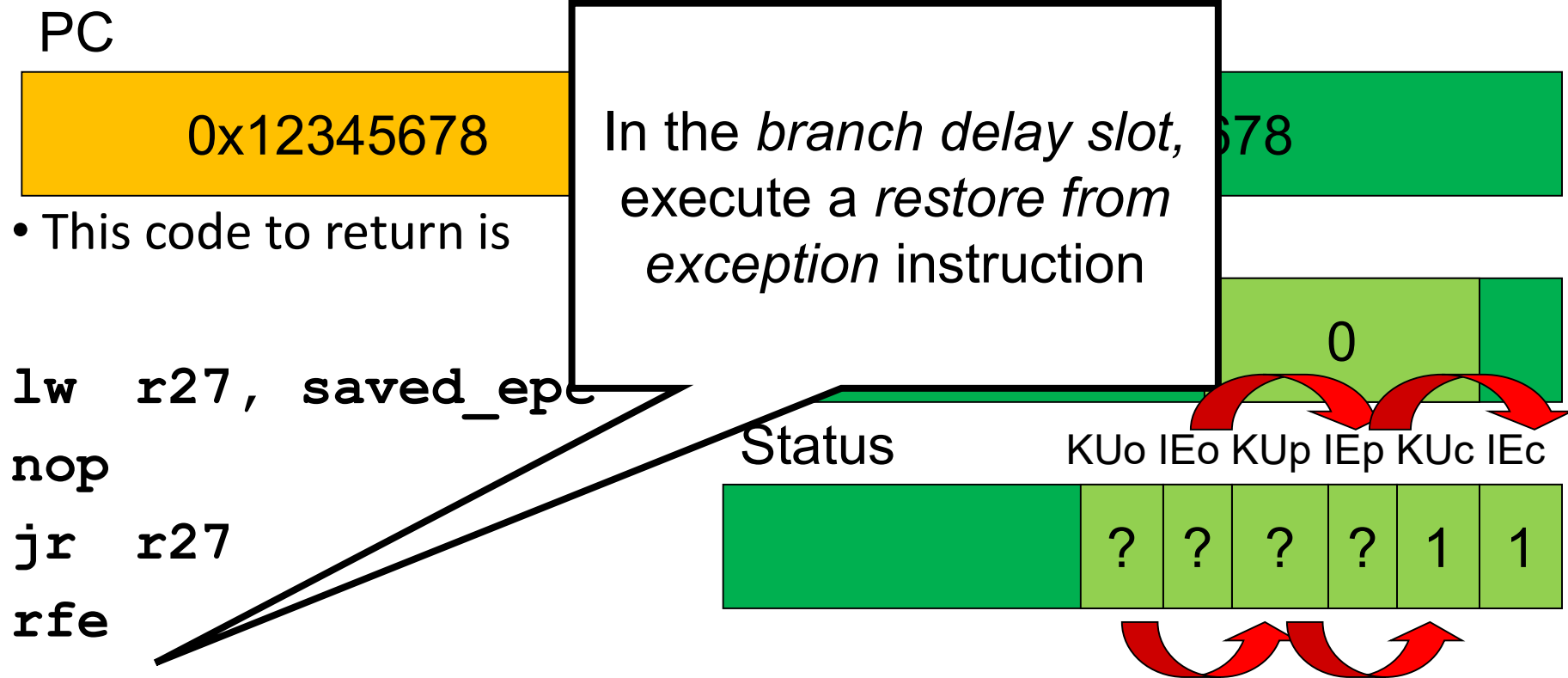

Returning from an exception

PC

0x12345678

- We are now back in the same state we were in when the exception happened

EPC

0x12345678

Cause

0

Status

	KUo	IEo	KUp	IEp	KUc	IEc
	?	?	?	?	1	1

MIPS System Calls

- System calls are invoked via a *syscall* instruction.
 - The *syscall* instruction causes an exception and transfers control to the general exception handler
 - A convention (an agreement between the kernel and applications) is required as to how user-level software indicates
 - Which system call is required
 - Where its arguments are
 - Where the result should go

OS/161 Systems Calls

- OS/161 uses the following conventions
 - Arguments are passed and returned via the normal C function calling convention
 - Additionally
 - Reg v0 contains the system call number
 - On return, reg a3 contains
 - 0: if success, v0 contains successful result
 - not 0: if failure, v0 has the errno.
 - v0 stored in errno
 - -1 returned in v0

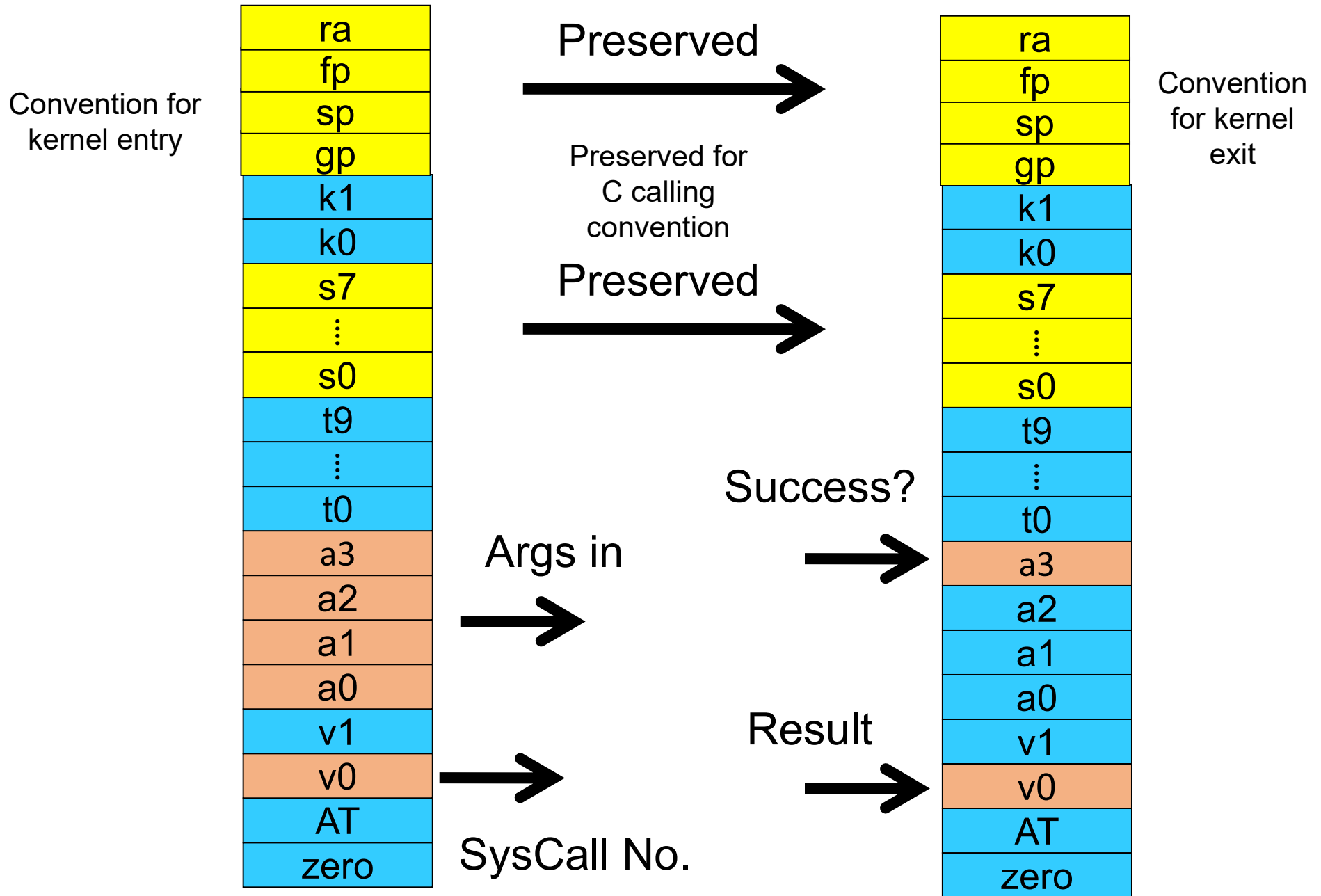

CAUTION

- Seriously low-level code follows
- This code is not for the faint hearted

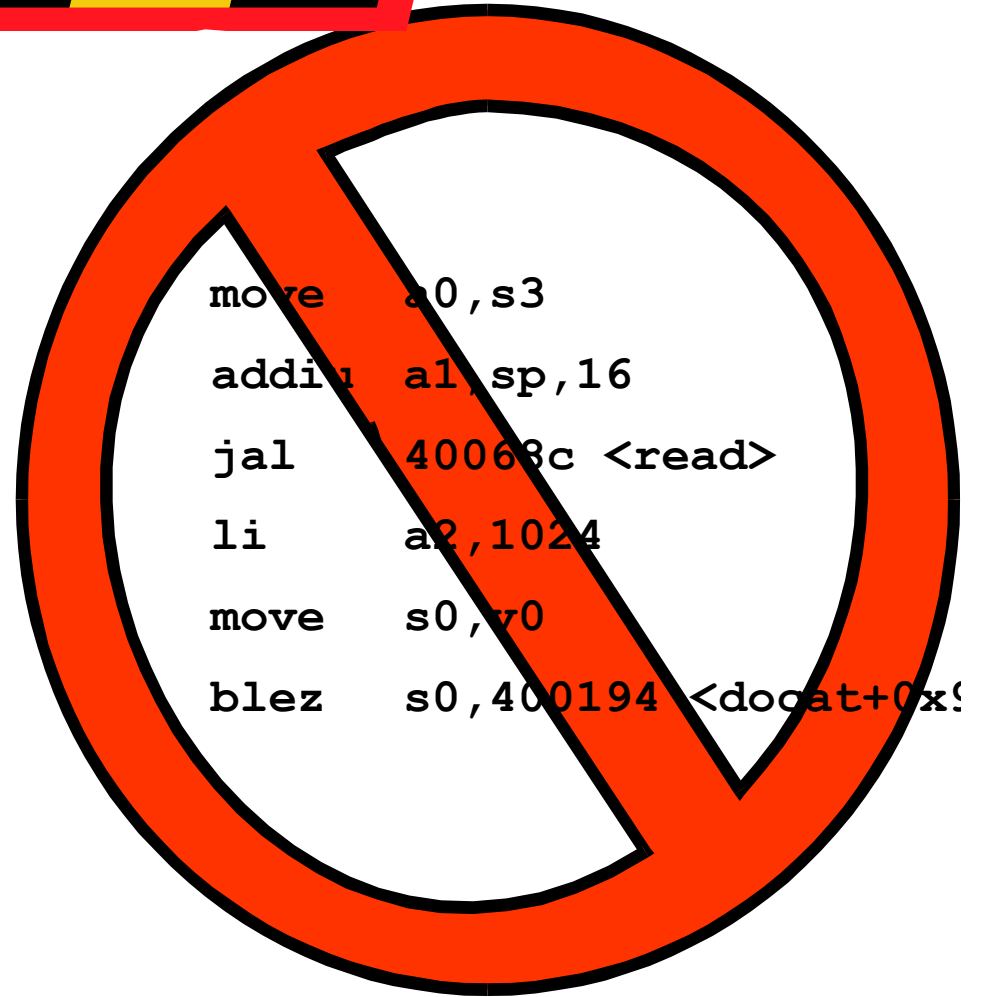

User-Level System Call Walk Through – Calling read()

```
int read(int filehandle, void *buffer, size_t size)
```

- Three arguments, one return value
- Code fragment calling the read function

```
400124:    02602021    move a0, s3
400128:    27a50010    addiu    a1, sp, 16
40012c:    0c1001a3    jal    40068c <read>
400130:    24060400    li    a2, 1024
400134:    00408021    move s0, v0
400138:    1a000016    blez s0, 400194
<docat+0x94>
```

- Args are loaded, return value is tested

Inside the read() syscall function part 1

0040068c <read>:

```
    40068c:    08100190    j    400640  
<__syscall>  
    400690:    24020005    li   v0,5
```

- Appropriate registers are preserved
 - Arguments (a0-a3), return address (ra), etc.
- The syscall number (5) is loaded into v0
- Jump (not jump and link) to the common syscall routine

The read() syscall function part 2

Generate a syscall
exception

00400640 <__syscall>:

400640: 0000000c

syscall

400644: 10e00005

beqz a3,40065c <__syscall+0x1c>

400648: 00000000

nop

40064c: 3c011000

lui at,0x1000

400650: ac220000

sw v0,0(at)

400654: 2403ffff

li v1,-1

400658: 2402ffff

li v0,-1

40065c: 03e00008

jr ra

400660: 00000000

nop

The read() syscall function part 2

```
00400640 <__syscall>:  
400640: 0000000c syscall  
400644: 10e00005 beqz a3,40065c<__syscall+0x1c>  
400648: 00000000 nop  
40064c: 3c011000 lui at,0x1000  
400650: ac220000 sw v0,0(at)  
400654: 2403ffff li v1,-1  
400658: 2402ffff li v0,-1  
40065c: 03e00008 jr ra  
400660: 00000000 nop
```

Test success, if yes,
branch to return
from function

The read() syscall function part 2

```
00400640 <__syscall>:  
400640: 0000000c syscall  
400644: 10e00005 beqz a3,400650  
400648: 00000000 nop  
40064c: 3c011000 lui at,0x1000  
400650: ac220000 sw v0,0(at)  
400654: 2403ffff li v1,-1  
400658: 2402ffff li v0,-1  
40065c: 03e00008 jr ra  
400660: 00000000 nop
```

If failure, store code
in *errno*

The read() syscall function part 2

```
00400640 <__syscall>:  
400640: 0000000c syscall  
400644: 10e00005 beqz a3,40065c  
400648: 00000000 nop  
40064c: 3c011000 lui at,0x100  
400650: ac220000 sw v0,0(a3)  
400654: 2403ffff li v1,-1  
400658: 2402ffff li v0,-1  
40065c: 03e00008 jr ra  
400660: 00000000 nop
```

Set read() result to
-1

The read() syscall function part 2

```
00400640 <__syscall>:  
400640: 0000000c syscall  
400644: 10e00005 beqz a3,40065c  
400648: 00000000 nop  
40064c: 3c011000 lui at,0x1000  
400650: ac220000 sw v0,0(at)4  
400654: 2403ffff li v1,-1  
400658: 2402ffff li v0,-1  
40065c: 03e00008 jr ra  
400660: 00000000 nop
```

Return to location
after where read()
was called

Summary

- From the caller's perspective, the `read()` system call behaves like a normal function call
 - It preserves the calling convention of the language
- However, the actual function implements its own convention by agreement with the kernel
 - Our OS/161 example assumes the kernel preserves appropriate registers(s0-s8, sp, gp, ra).
- Most languages have similar *libraries* that interface with the operating system.

System Calls - Kernel Side

- Things left to do
 - Change to kernel stack
 - Preserve registers by saving to memory (on the kernel stack)
 - Leave saved registers somewhere accessible to
 - Read arguments
 - Store return values
 - Do the “read()”
 - Restore registers
 - Switch back to user stack
 - Return to application

OS/161 Exception Handling

- Note: The following code is from the uniprocessor variant of OS161 (v1.x).
 - Simpler, but broadly similar to current version.

exception:

```
move k1, sp          /* Save previous stack pointer in k1 */
mfc0 k0, c0_status   /* Get status register */
andi k0, k0, CST_K   /* Check the we-were-in-user-mode bit */
beq    k0, $0, 1f    /* If clear, from kernel, already have stack */
nop
```

```
/* Coming from user mode, restore kernel stack to sp */
la k0, curkstack     /* "kernel stack" */
lw sp, 0(k0)
nop
```

1:

```
mfc0 k0, c0_cause    /* No exception cause. */
j common_exception   /*
nop
```

Note k0, k1
registers
available for
kernel use

exception:

```
move k1, sp          /* Save previous stack pointer in k1 */
mfc0 k0, c0_status   /* Get status register */
andi k0, k0, CST_Kup /* Check the we-were-in-user-mode bit */
beq      k0, $0, 1f /* If clear, from kernel, already have stack */
nop                               /* delay slot */

/* Coming from user mode - load kernel stack into sp */
la k0, curkstack      /* get address of "curkstack" */
lw sp, 0(k0)          /* get its value */
nop                               /* delay slot for the load */
```

1:

```
mfc0 k0, c0_cause /* Now, load the exception cause. */
j common_exception /* Skip to common code */
nop                               /* delay slot */
```

`common_exception:`

```
/*
 * At this point:
 *     Interrupts are off. (The processor did this for us.)
 *     k0 contains the exception cause value.
 *     k1 contains the old stack pointer.
 *     sp points into the kernel stack.
 *     All other registers are untouched.
 */

/*
 * Allocate stack space for 37 words to hold the trap frame,
 * plus four more words for a minimal argument block.
 */
addi sp, sp, -164
```

```
/* The order here must match mips/include/trapframe.h. */
```

```
sw ra, 160(sp) /* dummy for gdb */  
  sw s8, 156(sp) /* save s8 */  
  sw sp, 152(sp) /* dummy for gdb */  
  sw gp, 148(sp) /* save gp */  
  sw k1, 144(sp) /* dummy for gdb */  
  sw k0, 140(sp) /* dummy for gdb */  
  
  sw k1, 152(sp) /* real saved sp */  
  nop /* delay slot for store */  
  
  mfc0 k1, c0_epc /* Copr.0 reg 13 == PC for  
  sw k1, 160(sp) /* real saved PC */
```

These six stores are
a “hack” to avoid
confusing GDB
You can ignore the
details of why and
how

```
/* The order here must match mips/include/trapframe.h. */
```

```
sw ra, 160(sp) /* dummy for gdb */  
  sw s8, 156(sp) /* save s8 */  
  sw sp, 152(sp) /* dummy for gdb */  
  sw gp, 148(sp) /* save gp */  
  sw k1, 144(sp) /* dummy for gdb */  
  sw k0, 140(sp) /* dummy for gdb */  
  
  sw k1, 152(sp) /* real saved sp */  
  nop /* delay slot for store */  
  
  mfc0 k1, c0_epc /* Copr.0 reg 13 == PC for exception */  
  sw k1, 160(sp) /* real saved PC */
```

The real work starts here

```
sw t9, 136(sp)
sw t8, 132(sp)
sw s7, 128(sp)
sw s6, 124(sp)
sw s5, 120(sp)
sw s4, 116(sp)
sw s3, 112(sp)
sw s2, 108(sp)
sw s1, 104(sp)
sw s0, 100(sp)
sw t7, 96(sp)
sw t6, 92(sp)
sw t5, 88(sp)
sw t4, 84(sp)
sw t3, 80(sp)
sw t2, 76(sp)
sw t1, 72(sp)
sw t0, 68(sp)
sw a3, 64(sp)
sw a2, 60(sp)
sw a1, 56(sp)
sw a0, 52(sp)
sw v1, 48(sp)
sw v0, 44(sp)
sw AT, 40(sp)
sw ra, 36(sp)
```

Save all the registers
on the kernel stack

```

/*
 * Save special registers.
 */
mfhi t0
mflo t1
sw t0, 32(sp)
sw t1, 28(sp)

```

We can now use the other registers (t0, t1) that we have preserved on the stack

```

/*
 * Save remaining exception context information.
 */

sw k0, 24(sp)          /* k0 was loaded with cause earlier */
mfc0 t1, c0_status     /* Copr.0 reg 11 == status */
sw t1, 20(sp)
mfc0 t2, c0_vaddr      /* Copr.0 reg 8 == faulting vaddr */
sw t2, 16(sp)

/*
 * Pretend to save $0 for gdb's benefit.
 */
sw $0, 12(sp)

```

```
/*
 * Prepare to call mips_trap(struct trapframe *)
 */

addiu a0, sp, 16          /* set argument */
jal mips_trap             /* call it */
nop                       /* delay slot */
```

Create a pointer to the base of the saved registers and state in the first argument register

Kernel Stack

```
struct trapframe {
    u_int32_t tf_vaddr; /* vaddr register */
    u_int32_t tf_status; /* status register */
    u_int32_t tf_cause; /* cause register */
    u_int32_t tf_lo;
    u_int32_t tf_hi;
    u_int32_t tf_ra; /* Saved register 31 */
    u_int32_t tf_at; /* Saved register 1 (AT) */
    u_int32_t tf_v0; /* Saved register 2 (v0) */
    u_int32_t tf_v1; /* etc. */
    u_int32_t tf_a0;
    u_int32_t tf_a1;
    u_int32_t tf_a2;
    u_int32_t tf_a3;
    u_int32_t tf_t0;
    ...
    u_int32_t tf_t7;
    u_int32_t tf_s0;
    ...
    u_int32_t tf_s7;
    u_int32_t tf_t8;
    u_int32_t tf_t9;
    u_int32_t tf_k0;
    */
    u_int32_t tf_k1;
    u_int32_t tf_gp;
    u_int32_t tf_sp;
    u_int32_t tf_s8;
    u_int32_t tf_epc; /* coprocessor 0 epc register */
};
```

By creating a pointer to here of type struct trapframe *, we can access the user's saved registers as normal variables within 'C'

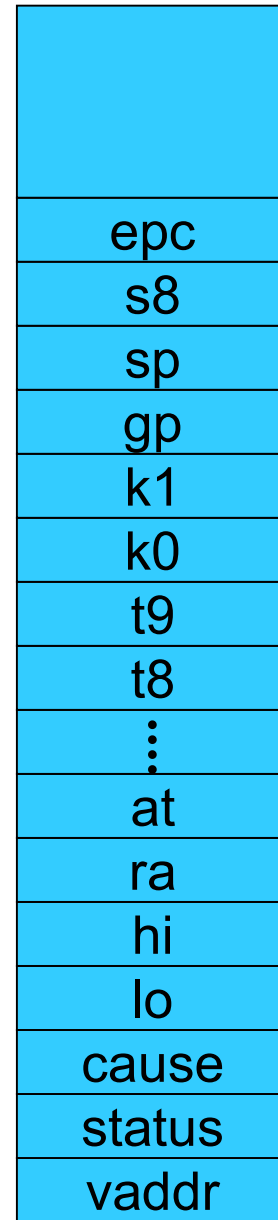

Now we arrive in the 'C' kernel

```
/*
 * General trap (exception) handling function for mips.
 * This is called by the assembly-language exception handler once
 * the trapframe has been set up.
 */
void
mips_trap(struct trapframe *tf)
{
    u_int32_t code, isutlb, iskern;
    int savespl;

    /* The trap frame is supposed to be 37 registers long. */
    assert(sizeof(struct trapframe)==(37*4));

    /* Save the value of curspl, which belongs to the old context. */
    savespl = curspl;

    /* Right now, interrupts should be off. */
    curspl = SPL_HIGH;
```

What happens next?

- The kernel deals with whatever caused the exception
 - Syscall
 - Interrupt
 - Page fault
 - It potentially modifies the *trapframe*, etc
 - E.g., Store return code in v0, zero in a3
- 'mips_trap' eventually returns

exception_return:

```
/*      16(sp)          no need to restore tf_vaddr */
lw t0, 20(sp)          /* load status register value into t0 */
nop                    /* load delay slot */
mtc0 t0, c0_status     /* store it back to coprocessor 0 */
/*      24(sp)          no need to restore tf_cause */

/* restore special registers */
lw t1, 28(sp)
lw t0, 32(sp)
mtlo t1
mthi t0

/* load the general registers */
lw ra, 36(sp)

lw AT, 40(sp)
lw v0, 44(sp)
lw v1, 48(sp)
lw a0, 52(sp)
lw a1, 56(sp)
lw a2, 60(sp)
lw a3, 64(sp)
```

```
lw t0, 68(sp)
  lw t1, 72(sp)
  lw t2, 76(sp)
  lw t3, 80(sp)
  lw t4, 84(sp)
  lw t5, 88(sp)
  lw t6, 92(sp)
  lw t7, 96(sp)
  lw s0, 100(sp)
  lw s1, 104(sp)
  lw s2, 108(sp)
  lw s3, 112(sp)
  lw s4, 116(sp)
  lw s5, 120(sp)
  lw s6, 124(sp)
  lw s7, 128(sp)
  lw t8, 132(sp)
  lw t9, 136(sp)

/*      140(sp)      "saved" k0 was dummy garbage anyway */
/*      144(sp)      "saved" k1 was dummy garbage anyway */
```



```

lw gp, 148(sp)      /* restore gp */
/*      152(sp)      stack pointer - below */
lw s8, 156(sp)     /* restore s8 */
lw k0, 160(sp)     /* fetch exception return PC into k0 */

lw sp, 152(sp)     /* fetch saved sp (must be last) */

/* done */
jr k0              /* jump back */
rfe               /* in delay slot */
.end common_exception

```

Note again that only
k0, k1 have been
trashed